

DISPLAY PRODUCTS CATALOG

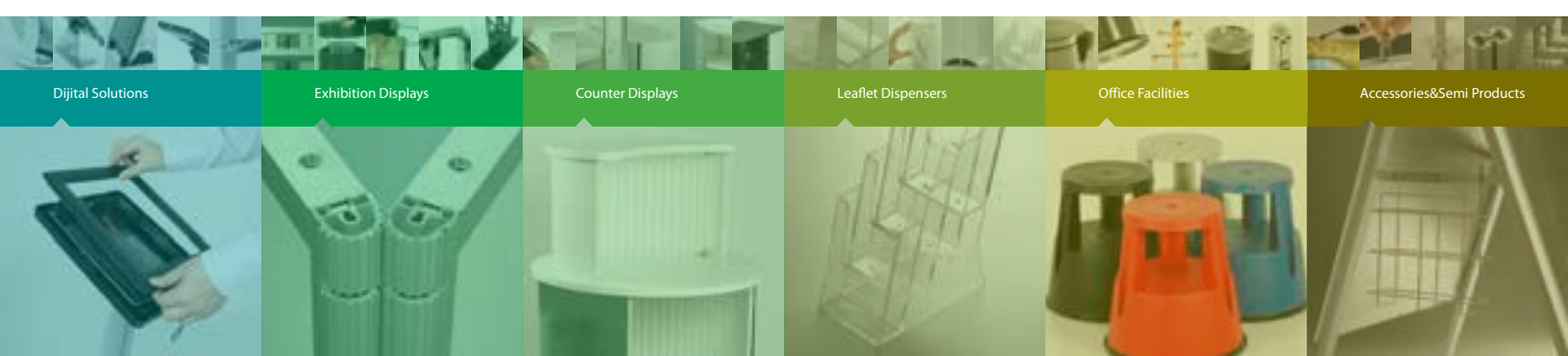

Presentation



The quality: high and approved

As the raw materials are chosen and the products created by MT Office & More, it is guaranteed a first-class quality.



Creative: Innovative and different

MT Office & More is creative and transforms offices into living spaces. It turns offices into business, businesses into market leaders and success stories. With inspired ingenuity and a steadfast commitment to excellence, MT Office & More forge in creative designing committing a difference.



Guarantee

MT Office & More guarantees excellent customer service with excellent products. The target always is that MT Office & More clients receive best products, prices and services possible.



Service

MT Office & More works on the basis of long-term partnership with its clients and does whatever necessary to make a consequential contribution to clients' businesses.





TUZLA 2500 m²

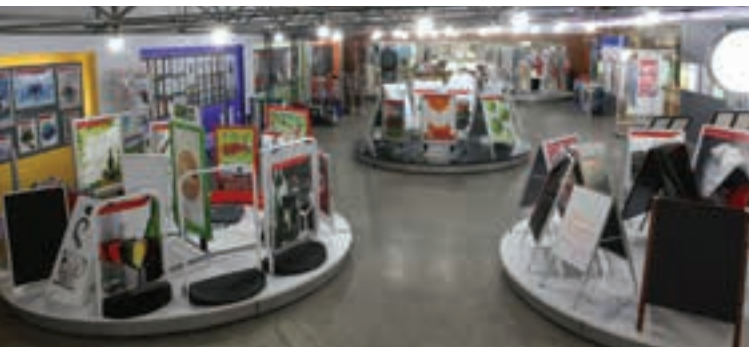

MT Displays LLC is the United States' sales and distribution branch of MT International Group.

MT International Group is a multinational group of companies with production facilities in 4 factories based in Turkey, distribution and warehousing facilities in 2 countries and finally sales & marketing activities in over 80 countries throughout the world. We have provided for all needs in the display and sign industry since 1993. Over the years our product offering has grown consistently in the global markets.

The strength of MT International Group is the ability of creating innovative designs to provide for the changes and expectations in the global market. Many of our innovative designs result in design protection and patents. Today MT International Group has more than 20 patented products in product range in the global markets. We offer 20,000 different SKU's to meet various needs in different types of markets. Our product range is suited for all the different markets throughout the world.

By producing raw material like APET, HIPS and PVC Foam to finished display products such as LED illuminated products, aluminium extrusion, cast outdoor banner systems and IP rated pavement signs; MT International is positioned to handle any job that comes our way with the highest level of quality and service.

Strengths:

- **In-House Design:** Our cutting-edge designs are made to your specifications with the highest level of sophistication.
- **Production Capacity:** Our large and flexible production lines ensure orders are produced with quick lead times and the highest efficiency.
- **Intense Quality Control:** In-house production; from raw materials to finished products, enable us to keep the highest quality standards in the industry.
- **Patent Power:** Dozens of engineers and designers are constantly working to create new and inventive concepts. Our target is to remain the market leader with an ever increasing line of original and ingenious products. All unique designs and production techniques are protected by patents.

Backed by MT International Group, MT Displays, LLC. was established as our sales and distribution branch in 2013 to be able to provide regional service and products to North America. It is your one-stop solution for all your display needs.

MT Displays, LLC. promises:

- Customer Service which is located in Moonachie, NJ. Our professional representatives are trained to answer all customer inquiries in a timely manner.
- Inventory availability in the USA from our NJ based distribution warehouse.
- Custom product offerings with state of the art manufacturing power behind us.

Index

Opti Frames

7-16

- Opti Frame® 0.55" / 14 mm
- Opti Frame® 1" / 25 mm
- Opti Frame® in Colors

Poster Frames

17-40

- Snap Frames **NEW**
- Fire Resistant Snap Frames
- Window Frames
- Fancy Frames
- Double Sided Snap Frames
- Security Frames
- Lockable Snap Frames
- Double Color Frames
- Paperboard
- Magnetic Frames

Slide-in Frames

41-44

- Counter Slide-in Frames
- Single Sided Slide-in Frames
- Double Sided Slide-in Frames

Weatherproof Frames

45-48

- Lockable Weatherproof Frames
- Weatherproof Frame 1" / 25mm
- Weatherproof Frame 1.38" / 35mm

Poster Hangers

49-56

- Poster Snaps
- Banner Hangers
- Poster Fasts
- Stretch Frames
- Poster Clamps
- Outdoor Flap Grippers

Showboards

57-60

- Poster Showboards
- Universal Poster Showboards

Banner Stands

61-72

- Cross Single Banner **NEW**
- Quick Banners
- Newage Quick Banners
- Retractable Roll Up Stands
- Smart Roll Banners
- Easy Swaps
- Poster Traps
- Cross Banners
- Optima Banners
- Eco Roll Banners
- Super Eco Roll Banners

Printable Solutions

73-92

- Maxi Frames
- Star Maxi LED
- Power LED
- Maxi Frame Totem with LED
- Omni Frames
- Omni A Boards

Sign Holders

93-108

- Poster Stands
- Oval Based Floor Poster Stands
- Eco Floor Poster Stands
- Novel Display Stands
- Display Stands
- Display Stand Banner Sets
- Display Stand Slide-in Frames
- Poster Display Convex Boxes
- Totems
- Decorative Totems
- Mono Totems
- LEDA Illuminated Magnetic Totems

Literature Racks

109-134

- Free Standing Leaflet with Side Shelves
- Cocktail Brochure Sets
- Cocktail Brochure Sets for Wall
- Prime Wall Units
- Portable Leaflet Dispensers
- Multiside Brochure Sets
- Brochure Sets
- Decorative Brochure Stands
- Decorative Brochure Stands Plus
- Pillar Brochure Stands
- Zick-Zacks
- Double Leg Zick-Zacks
- Zic-Zack Lites
- Rapid Brochure Set
- Curved Reversible Tower Brochure Stand
- Twin Reversible Tower Brochure Stand
- Convex Reversible Tower Brochure Stand
- Double Sided Reversible Tower Brochure Stand
- Basic Reversible Tower Brochure Stand
- Reversible Tower Brochure Stand for Wall
- Newage Portable Zick-Zacks
- Portable Zick-Zacks
- Wood Zick-Zack **NEW**
- Monoblocks

LED Signs

135-150

- Buy Max LEDbox **NEW**
- Best Buy LEDbox
- Smart LEDbox 25 mm
- Smart LEDbox 35 mm
- Weatherproof Smart LEDbox 35 mm
- Lockable Weatherproof Smart LEDbox 35 mm
- Magneco LEDbox
- Convex LEDbox
- Acryled for Wall Mounting

Message Boards

151-160

- Frameboards
- Write-on Boards
- Magnetic Glass Board
- Enclosed Bulletin Boards
- Premium Grade Enclosed Bulletin Boards

Floor Signs

161-178

- Flexible Sign Holders
- Flexible Sign Holder with Ledbox
- Arc Sign Holder **NEW**
- Telescoping Sign Holders **NEW**
- Floor Sign Holder **NEW**
- Folder Sign Holder
- Restaurant Boards
- Curved Sign Holder
- Curved Sign Holder with Acryled
- Universal Showboard on Curved Post
- Paper Board Sign Holder
- Classical Sign Holder
- Decorative Sign Holder
- Adjustable Sign Holder

Sidewalk Signs

179-212

- A Board
- Eco A Board
- Premium A Board with logo
- Premium A Board with Profile logo
- Opti A Board
- Weatherproof A Board
- Write-on A Board
- Slide-in A Board
- Stainless Steel A Board
- Easy Go A Board
- Wood Look A Board
- Street SignPro® **NEW**
- SwingPro®&WindPro® Plus
- SwingPro®&WindPro® Lite
- BannerPro®
- Slide-in WindPro®
- Illuminated WindPro® with LED
- Swingmaster
- Eco Swingmaster
- Waterbase Wind Sign
- Eco Waterbase Wind Sign
- Al Maki
- Rectangular Iron A Board
- Magnetic Iron A Board
- Waterbase Pavement Signs
- PS Boards

Wood Displays

213-226

- Easy Wood Frame
- Frameless Wooden Frame
- Wooden Stopper
- Wooden Host
- Wood A Board Outdoor
- Wood A Board Indoor
- Timber Chalk Board **NEW**
- Wall Mount Wooden Card Holder **NEW**
- Desktop Wooden Card Holder **NEW**
- Wood Magazine Rack for Wall **NEW**
- Free Standing Wood Magazine Rack **NEW**
- Wood Podium **NEW**
- Foldable Wood Box **NEW**

Stanchions

227-234

- Q Belt
- Q Belt for Wall
- Retractable Stanchion Crowd Control Posts
- Crowd Control Stanchion Poles & Ropes
- Q Rope
- Street Barrier

Exhibition Displays

235-260

- Crown Truss **NEW**
- Pop-up with Magnetic
- Panset
- Panset Hexagonal Counter
- Panset Convex Counter
- Midsize Convex Counter
- Foldable Wood Counter **NEW**
- Pop-up Counter
- Promostand
- Petite Promostand
- Seed Promostand
- Rectangular Promostand
- Circle Promostand
- Bean Promostand
- Tumble Box
- Puzzle Tumble Box
- Free Standing Puzzle Tumble Box

Office Products

261-284

- Door Signs
- Desktop Sign
- Wall Sign System
- Wall Sign Double Sided
- Sign Systems
- Clip Board
- Fast Note
- Magnetic Glass Board
- Business Card Holder
- Coat Racks
- Waste Baskets
- 2 Step Plastic Stepstool

Presentation Systems

285-300

- White Boards
- Map Boards
- Reference Racks
- Flipcharts
- Easels **NEW**

Tablet & TV Stands

301-314

- TV Stands
- Counter Tablet Holders
- Tablet Kiosk
- Boomerang Floor Tablet Stand
- Spider Floor Tablet Stand
- Red Spider Floor Tablet Stand

Brochure Holders&Leaflet Displays

315-338

- Photo Frame
- Cross Frame
- Leaflet Dispensers
- Multiple Pocket Leaflet Dispensers
- Wall Mount Leaflet Dispensers
- Clear Brochure Holder T Type
- Clear Brochure Holder T Type
- L Type with front Pocket
- Swing Wing
- Pet Pocket
- Foldable Leaflet Holder
- Upright Leaflet Holder
- Oval Leaflet Holder
- Duo Desktop Menu Holder **NEW**
- Fort Desktop Menu Holder **NEW**
- Curved Desktop Menu Holder **NEW**
- Ticket Holder **NEW**
- Card Holder 2 Sided **NEW**
- Pyramid Card Holder **NEW**
- Arc Menu Holder **NEW**

Accessories

339-344

- Hangers
- Baskets
- Shelves
- Header Holder & Header
- Bags
- Levertool
- Separator
- Chalkboard Marker
- Lighting Components
- Panel
- Other

Semi Products

345-354

- Profiles
- Corners
- Connectors
- Springs
- End Caps
- Hangers
- Pipes
- Feet
- Counter Support
- Logo
- Shelf
- Panel
- Power Supply
- Base
- Others

Extrusion Lines

355-362

- PET lines
- Plastech PVC Foam Lines
- Neo Plastech PVC Foam Lines
- Plasteco PVC Foam Lines
- HIPS Lines

General Information

363

- Symbols
- RAL Charts

Factory Management

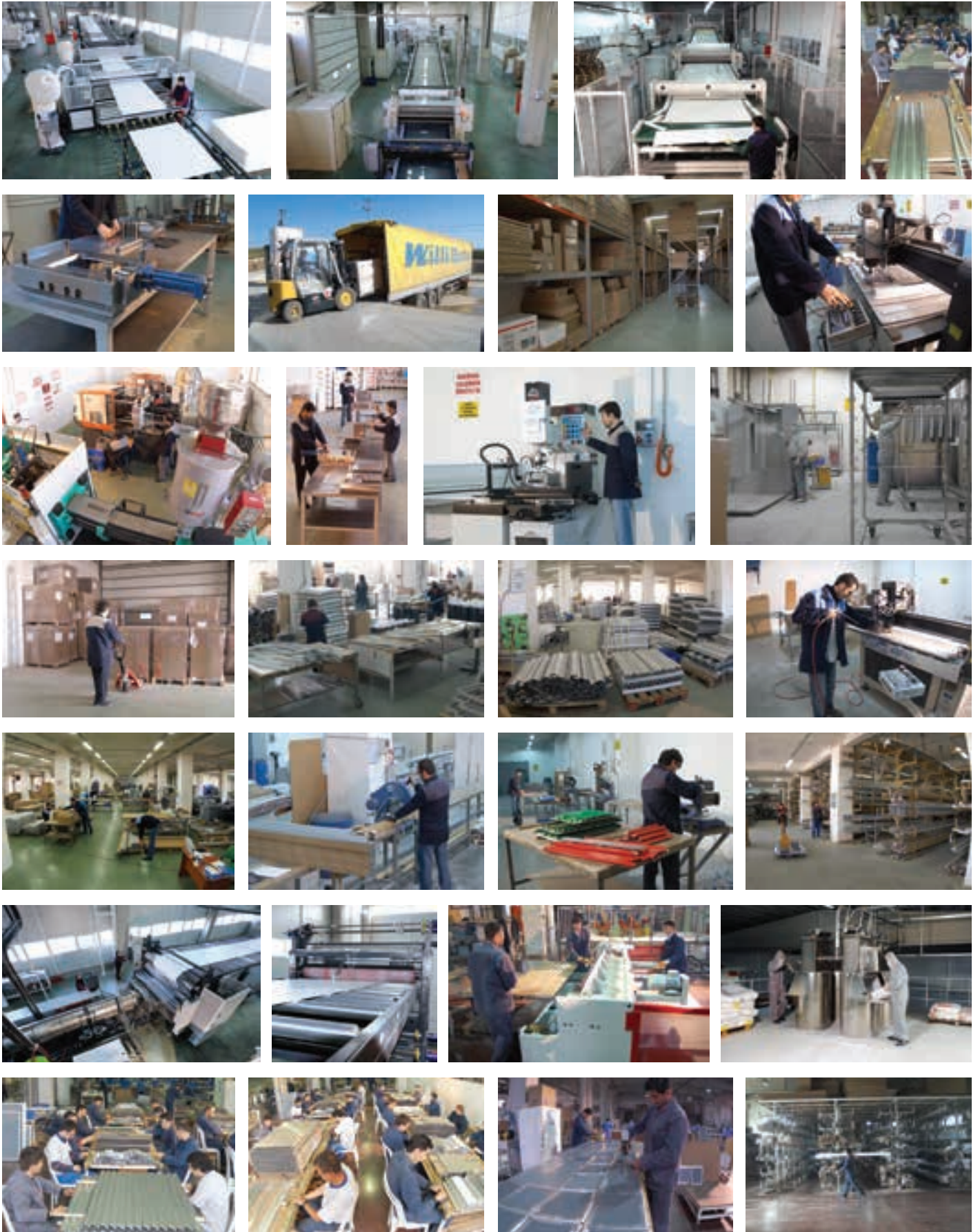



Opti Frames®

- Opti Frame® 0.55" / 14 mm
 - 0.55" / 14 mm Silver Anodized
 - 0.55" / 14 mm Black
 - 0.55" / 14 mm Wood Effect
- Opti Frame® 1" / 25 mm
 - 1" / 25 mm Silver Anodized
 - 1" / 25 mm Black
 - 1" / 25 mm Wood Effect
- Opti Frame® in Colors



With our new product, we aim to bring a new dimension of performance to retail display frames.

Our R&D team has focused their extensive knowledge on transforming production processes to create a completely new type of front loading display frame.

Opti Frame not only delivers multi functional applications with a variety of mounting options, but is specifically engineered to offer very competitive pricing in response to the demands of the competitive snap frame market.

The product is protected worldwide by relevant patent applications.

Our Opti Frame family progressively welcomes new additions in sizes.

Opti Frame can be used for signage needs in many locations: Offices, hotels, hospitals, schools, airports, stores, apartments and many more..

Profile Type

0.55" - 14 mm

1" - 25 mm



Frame Color



Silver



Black



Wood Effect

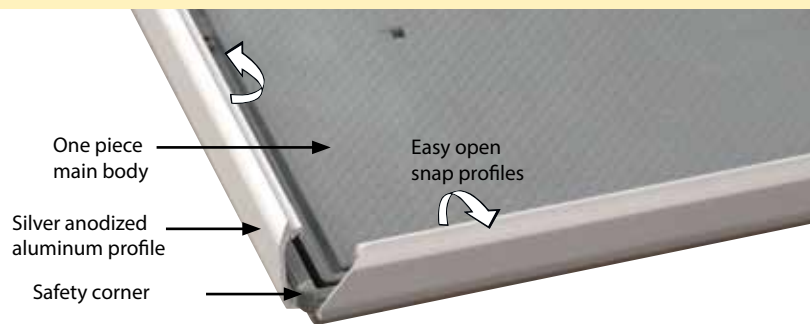

Smart design with distinctive features... "no sharp edges"

Optimized use! Goes on counters, goes on walls...

Multi functional use

Low cost snap frames with advanced design

Poster Size	PROFILE OPTIONS		
	0.55" Profile Safety	1" Profile Safety	Counter Support
5"X7"	✓	x	✓
8"X10"	✓	x	✓
8.5"X11"	x	✓	✓
11"X17"	x	✓	x
22"X28"	x	✓	x

Opti Frame can be used for signage needs in many locations: Offices, hotels, hospitals, schools, airports, stores, apartments and many more...

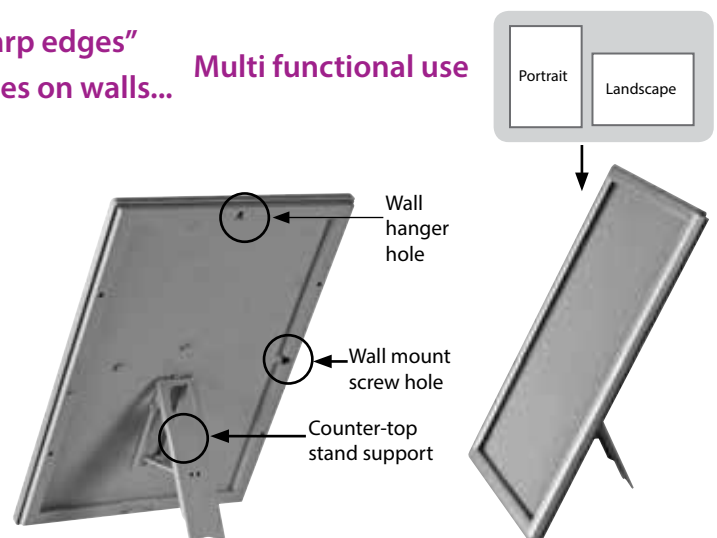

Opti Frames®



See movie at our website www.mtdisplays.com.tr



0.55" / 14 mm Profile, 45°

- Gray color backing and counter support.
- The front profiles are silver anodized.
- Eco-friendly.
- The product is protected worldwide by all relevant patent applications.
- Anti-glare poster cover sheet.

Opti Frame comes ready for wall mounting with 2 holes on both long sides. Wall hanging is also available with wall hanger holes placed on short and long sides.

Optional counter support offers a new counter stand position available standard in each unit in portrait and landscape position. Safety corners ensure maximum safety in public areas.

Suitable for silk screen printing, max. letter height is 0.28" mm.

Patent: PCT/TR06/000018 - WO 2007/126397 - EP 2016574 - DE 20 2006 020 145 - US 2009/211134 - AU 2006342800 - CN 101473363 - CA 2654307 - UA 2008 13893 - EA 200802174/26 - IN WO 2007/126397 - ZA 2008/09638 - TR 2007 05704 - OHIM 831235-0001,2,3,4



Multi functional use

Portrait

Landscape

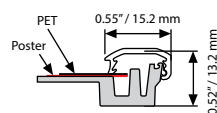
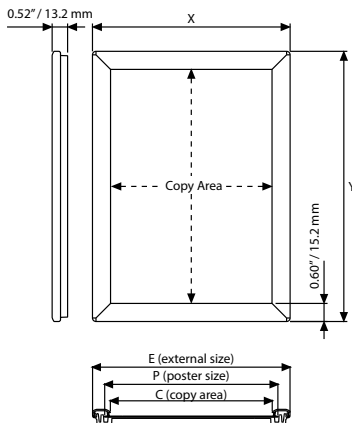

MATERIAL : Silver anodized aluminum PROFILE : 0.55" / 45°					WEIGHT	PACKING SIZE
ARTICLE	EXTERNAL (x-y)	POSTER	COPY	DESCRIPTION	WITH PACKING	*W X H X D
UCP145N057	5.83" X 7.83"	5" X 7"	4.61" X 6.61"	Without support	0.396 lbs	6.69" X 8.66" X 0.94"
UCP145N157	5.83" X 7.83"	5" X 7"	4.61" X 6.61"	With support	0.396 lbs	6.69" X 8.66" X 0.94"
UCP145N000	8.82" X 10.83"	8" X 10"	7.60" X 8.82"	Without support	0.661 lbs	10.24" X 12.20" X 0.94"
UCP145N100	8.82" X 10.83"	8" X 10"	7.60" X 8.82"	With support	0.661 lbs	10.24" X 12.20" X 0.94"

*W:Width H: Height D: Depth



Opti Frames®



See movie at our website www.mtdisplays.com.tr



0.55" / 14 mm Profile, 45° - Black

- Black color backing and counter support.
- The front profiles have black powder coating RAL 9005.
- Eco-friendly.
- The product is protected worldwide by all relevant patent applications.
- Anti-glare poster cover sheet.



Opti Frame comes ready for wall mounting with 2 holes on both long sides. Wall hanging is also available with wall hanger holes placed on short and long sides.



Optional counter support offers a new counter stand position available standard in each unit in portrait and landscape position. Safety corners ensure maximum safety in public areas.



Suitable for silk screen printing, max. letter height is 0.28" mm.

Patent: PCT/TR06/000018 - WO 2007/126397 - EP 2016574 - DE 20 2006 020 145 - US 2009/211134 - AU 2006342800 - CN 101473363 - CA 2654307 - UA 2008 13893 - EA 200802174/26 - IN WO 2007/126397 - ZA 2008/09638 - TR 2007 05704 - OHIM 831235-0001,2,3,4



Multi functional use

Portrait

Landscape

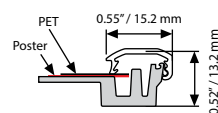
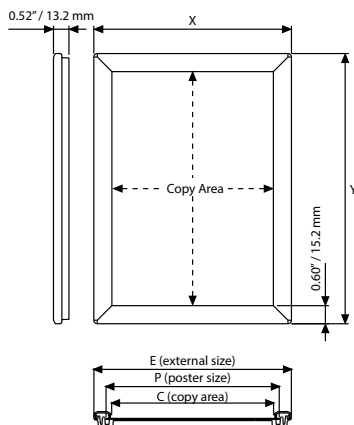

MATERIAL : Black powder coated RAL 9005 PROFILE : 0.55" / 45°					WEIGHT	PACKING SIZE
ARTICLE	EXTERNAL (x-y)	POSTER	COPY	DESCRIPTION	WITH PACKING	*W X H X D
UCP145B057	5.83" X 7.83"	5" X 7"	4.61" X 6.61"	Without support	0.396 lbs	6.69" X 8.66" X 0.94"
UCP145B157	5.83" X 7.83"	5" X 7"	4.61" X 6.61"	With support	0.396 lbs	6.69" X 8.66" X 0.94"
UCP145B000	8.82" X 10.83"	8" X 10"	7.60" X 8.82"	Without support	0.661 lbs	9.84" X 12.60" X 0.94"
UCP145B100	8.82" X 10.83"	8" X 10"	7.60" X 8.82"	With support	0.661 lbs	9.84" X 12.60" X 0.94"

*W:Width H:Height D:Depth



Opti Frames®



See movie at our website www.mtdisplays.com.tr



0.55" / 14 mm Profile, 45° - Wood Effect

- Wooden color backing and counter support.
- The front profiles have a wood effect finish.
- Eco-friendly.
- The product is protected worldwide by all relevant patent applications.
- Anti-glare poster cover sheet.



Opti Frame comes ready for wall mounting with 2 holes on both long sides. Wall hanging is also available with wall hanger holes placed on short and long sides.



Optional counter support offers a new counter stand position available standard in each unit in portrait and landscape position. Safety corners ensure maximum safety in public areas.



Suitable for silk screen printing, max. letter height is 0.28" mm.

Patent: PCT/TR06/000018 - WO 2007/126397 - EP 2016574 - DE 20 2006 020 145 - US 2009/211134 - AU 2006342800 - CN 101473363 - CA 2654307 - UA 2008 13893 - EA 200802174/26 - IN WO 2007/126397 - ZA 2008/09638 - TR 2007 05704 - OHIM 831235-0001,2,3,4



Multi functional use

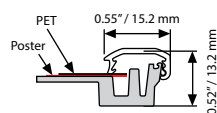
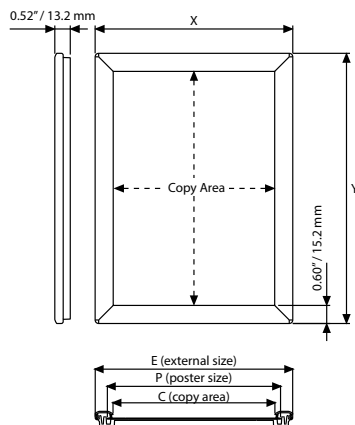
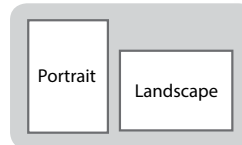

MATERIAL : Wood Look Effect PROFILE : 0.55" / 45°				WEIGHT	PACKING SIZE
ARTICLE	EXTERNAL (x-y)	POSTER	COPY	DESCRIPTION	WITH PACKING *W X H X D
UCP145W057	5.83" X 7.83"	5" X 7"	4.61" X 6.61"	Without support	0.396 lbs 6.69" X 8.66" X 0.94"
UCP145W157	5.83" X 7.83"	5" X 7"	4.61" X 6.61"	With support	0.396 lbs 6.69" X 8.66" X 0.94"
UCP145W000	8.82" X 10.83"	8" X 10"	7.60" X 8.82"	Without support	0.661 lbs 9.84" X 12.60" X 0.94"
UCP145W100	8.82" X 10.83"	8" X 10"	7.60" X 8.82"	With support	0.661 lbs 9.84" X 12.60" X 0.94"

*W:Width H: Height D: Depth



Opti Frames®



See movie at our website www.mtdisplays.com.tr



1" / 25 mm Profile, 45°

- Gray color backing and counter support.
- The front profiles are silver anodized.
- Eco-friendly.
- The product is protected worldwide by all required patent applications.
- Anti-glare poster cover sheet.

Opti Frame comes ready for wall mounting with 2 holes on both long sides. Wall hanging is also available with wall hanger holes placed on short and long sides.

Optional counter support offers a new counter stand position available standard in each unit in portrait and landscape position. Safety corners ensure maximum safety in public areas.

Suitable for silk screen printing, max. letter height is 0.59".

Patent: PCT/TR06/000018 - WO 2007/126397 - EP 2016574 - DE 20 2006 020 145 - US 2009/211134 - AU 2006342800 - CN 101473363 - CA 2654307 - UA 2008 13893 - EA 200802174/26 - IN WO 2007/126397 - ZA 2008/09638 - TR 2007 05704 - OHIM 831235-0001,2,3,4

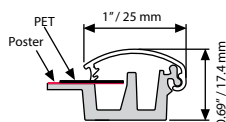
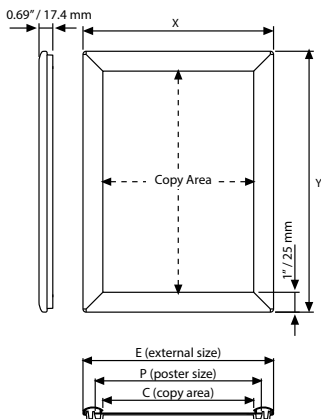
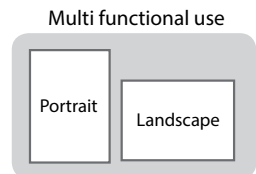

MATERIAL : Silver anodized aluminum PROFILE : 1" / 45°					WEIGHT	PACKING SIZE
ARTICLE	EXTERNAL (x-y)	POSTER	COPY	DESCRIPTION	WITH PACKING	*W X H X D
UCP255N081	9.72" X 12.22"	8.5" X 11"	7.75" X 10.25"	Without support	0.981 lbs	10.63" X 13.39" X 0.94"
UCP255N181	9.72" X 12.22"	8.5" X 11"	7.75" X 10.25"	With support	0.981 lbs	10.63" X 13.39" X 0.94"
UCP255N017	12.22" X 18.22"	11" X 17"	9.78" X 15.78"	Without support	1.873 lbs	12.99" X 18.90" X 0.94"
UCP255N022	23.22" X 29.22"	22" X 28"	21.25" X 27.25"	Without support	4.034 lbs	23.62" X 29.53" X 0.94"

*W:Width H: Height D: Depth



Opti Frames®



See movie at our website www.mtdisplays.com.tr



1" / 25 mm Profile, 45° - Black

- Black color backing and counter support.
- The front profiles have black powder coating RAL 9005.
- Eco-friendly.
- The product is protected worldwide by all relevant patent applications.
- Anti-glare poster cover sheet.

Opti Frame comes ready for wall mounting with 2 holes on both long sides. Wall hanging is also available with wall hanger holes placed on short and long sides.

Optional counter support offers a new counter stand position available standard in each unit in portrait and landscape position. Safety corners ensure maximum safety in public areas.

Suitable for silk screen printing, max. letter height is 0.59".

Patent: PCT/TR06/000018 - WO 2007/126397 - EP 2016574 - DE 20 2006 020 145 - US 2009/211134 - AU 2006342800 - CN 101473363 - CA 2654307 - UA 2008 13893 - EA 200802174/26 - IN WO 2007/126397 - ZA 2008/09638 - TR 2007 05704 - OHIM 831235-0001,2,3,4



Multi functional use

Portrait

Landscape

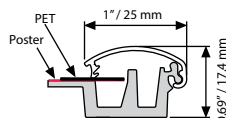
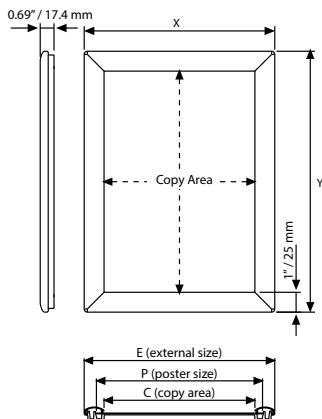

MATERIAL : Black powder coated RAL 9005 PROFILE : 1" / 45°					WEIGHT	PACKING SIZE
ARTICLE	EXTERNAL (x-y)	POSTER	COPY	DESCRIPTION	WITH PACKING	*W X H X D
UCP2558081	9.72" X 12.22"	8.5" X 11"	7.75" X 10.25"	Without support	0.981 lbs	10.63" X 13.39" X 0.94"
UCP2558181	9.72" X 12.22"	8.5" X 11"	7.75" X 10.25"	With support	0.981 lbs	10.63" X 13.39" X 0.94"
UCP2558017	12.22" X 18.22"	11" X 17"	9.78" X 15.78"	Without support	1.873 lbs	12.99" X 18.90" X 0.94"
UCP2558022	23.22" X 29.22"	22" X 28"	21.25" X 27.25"	Without support	4.034 lbs	23.62" X 29.53" X 0.94"

*W:Width H:Height D:Depth



Opti Frames®



See movie at our website www.mtdisplays.com.tr



1" / 25 mm Profile, 45° - Wood Effect

- Wooden color backing and counter support.
- The front profiles have a Wood Effect Finish.
- Eco-friendly.
- The product is protected worldwide by all required patent applications.
- Anti-glare poster cover sheet.



Opti Frame comes ready for wall mounting with 2 holes on both long sides. Wall hanging is also available with wall hanger holes placed on short and long sides.



Optional counter support offers a new counter stand position available standard in each unit in portrait and landscape position. Safety corners ensure maximum safety in public areas.

Patent: PCT/TR06/000018 - WO 2007/126397 - EP 2016574 - DE 20 2006 020 145 - US 2009/211134 - AU 2006342800 - CN 101473363 - CA 2654307 - UA 2008 13893 - EA 200802174/26 - IN WO 2007/126397 - ZA 2008/09638 - TR 2007 05704 - OHIM 831235-0001,2,3,4

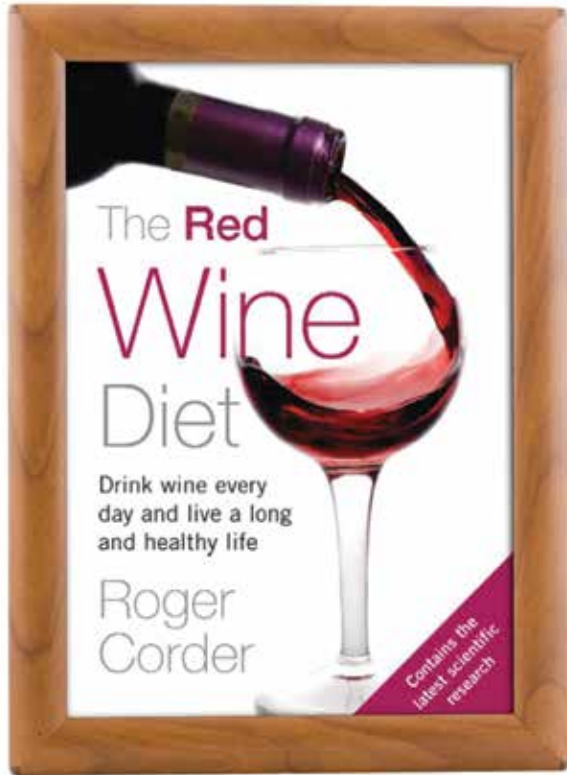

Multi functional use

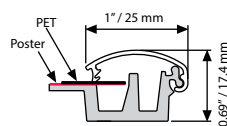
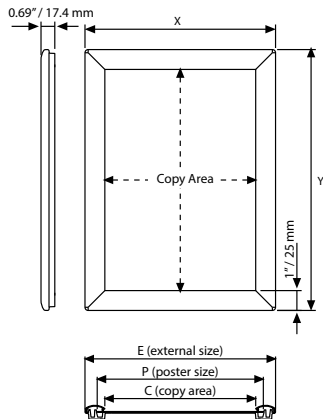
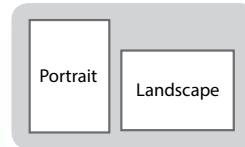

MATERIAL : Wood Look Effect PROFILE : 1" / 45°					WEIGHT	PACKING SIZE
ARTICLE	EXTERNAL (x-y)	POSTER	COPY	DESCRIPTION	WITH PACKING	*W X H X D
UCP255W181	9.72" X 12.22"	8.5" X 11"	7.75" X 10.25"	With support	0.981 lbs	10.63" X 13.39" X 0.94"

*W:Width H: Height D: Depth



Opti Frame® Now in Colors

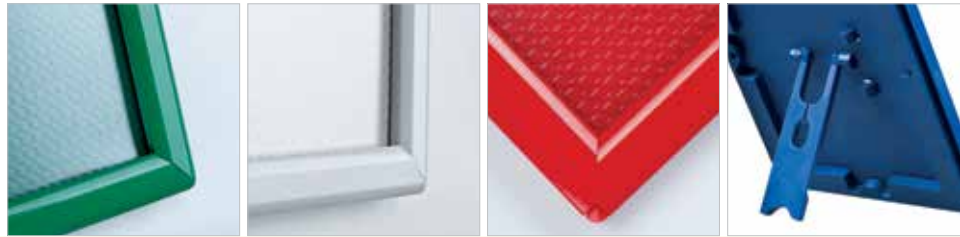

Spring colors in Opti Frame
Multi-functional Opti Frame is now available in colors.
New colors in different sizes. No minimum order quantity. Fits well in all environments.



6 Colors



Stands on counter

Opti®
Frame
www.opti-frame.com

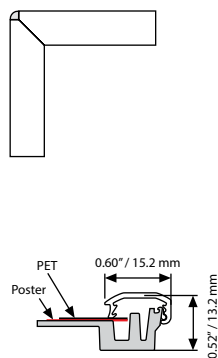
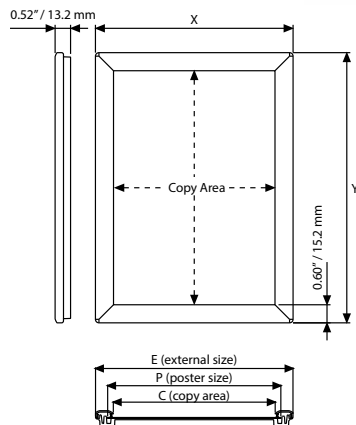

MATERIAL : RAL powder coated PROFILE : 0.55\"/> <th>WEIGHT</th> <th>PACKING SIZE</th>					WEIGHT	PACKING SIZE
ARTICLE	EXTERNAL (x-y)	POSTER	COPY	DESCRIPTION	WITH PACKING	*W X H X D
UCP145B157	5.83\"/> <td>5\"/> <td>4.61\"/> <td>RAL 9005 - Black</td> <td>0.396 lbs</td> <td>6.69\"/> </td></td></td>	5\"/> <td>4.61\"/> <td>RAL 9005 - Black</td> <td>0.396 lbs</td> <td>6.69\"/> </td></td>	4.61\"/> <td>RAL 9005 - Black</td> <td>0.396 lbs</td> <td>6.69\"/> </td>	RAL 9005 - Black	0.396 lbs	6.69\"/>
UCP145E157	5.83\"/> <td>5\"/> <td>4.61\"/> <td>RAL 6029 - Green</td> <td>0.396 lbs</td> <td>6.69\"/> </td></td></td>	5\"/> <td>4.61\"/> <td>RAL 6029 - Green</td> <td>0.396 lbs</td> <td>6.69\"/> </td></td>	4.61\"/> <td>RAL 6029 - Green</td> <td>0.396 lbs</td> <td>6.69\"/> </td>	RAL 6029 - Green	0.396 lbs	6.69\"/>
UCP145H157	5.83\"/> <td>5\"/> <td>4.61\"/> <td>RAL 9003 - White</td> <td>0.396 lbs</td> <td>6.69\"/> </td></td></td>	5\"/> <td>4.61\"/> <td>RAL 9003 - White</td> <td>0.396 lbs</td> <td>6.69\"/> </td></td>	4.61\"/> <td>RAL 9003 - White</td> <td>0.396 lbs</td> <td>6.69\"/> </td>	RAL 9003 - White	0.396 lbs	6.69\"/>
UCP145L157	5.83\"/> <td>5\"/> <td>4.61\"/> <td>RAL 5002 - Blue</td> <td>0.396 lbs</td> <td>6.69\"/> </td></td></td>	5\"/> <td>4.61\"/> <td>RAL 5002 - Blue</td> <td>0.396 lbs</td> <td>6.69\"/> </td></td>	4.61\"/> <td>RAL 5002 - Blue</td> <td>0.396 lbs</td> <td>6.69\"/> </td>	RAL 5002 - Blue	0.396 lbs	6.69\"/>
UCP145Y157	5.83\"/> <td>5\"/> <td>4.61\"/> <td>RAL 1021 - Yellow</td> <td>0.396 lbs</td> <td>6.69\"/> </td></td></td>	5\"/> <td>4.61\"/> <td>RAL 1021 - Yellow</td> <td>0.396 lbs</td> <td>6.69\"/> </td></td>	4.61\"/> <td>RAL 1021 - Yellow</td> <td>0.396 lbs</td> <td>6.69\"/> </td>	RAL 1021 - Yellow	0.396 lbs	6.69\"/>
UCP145R157	5.83\"/> <td>5\"/> <td>4.61\"/> <td>RAL 3020 - Red</td> <td>0.396 lbs</td> <td>6.69\"/> </td></td></td>	5\"/> <td>4.61\"/> <td>RAL 3020 - Red</td> <td>0.396 lbs</td> <td>6.69\"/> </td></td>	4.61\"/> <td>RAL 3020 - Red</td> <td>0.396 lbs</td> <td>6.69\"/> </td>	RAL 3020 - Red	0.396 lbs	6.69\"/>



* W:Width H: Height D: Depth



Gift Gate
BIG SALE
UP TO **80% OFF**
Aug. 25, 2012
10am - 10pm
at NBC Tent, Fort Belknap, Global City
Entrance Fee P20

Gift Gate
BIG SALE
UP TO **80% OFF**
Aug. 25, 2012
10am - 10pm
at NBC Tent, Fort Belknap, Global City
Entrance Fee P20





Poster Frames

- Snap Frames
 - 0.59" / 15 mm
 - 0.78" / 20 mm
 - 1" / 25 mm
 - 1" / 25 mm Gold Look
 - 1" / 25 mm Chrome Look
 - 1" / 25 mm Stainless Steel Look
 - 1" / 25 mm Black Anodized
 - 1" / 25 mm Wood Look Effect
 - 1" / 25 mm Coloured Snap Frame **NEW**
- Fancy Frames
 - 1.18" / 30 mm
 - 1.25" / 32 mm
 - 1.25" / 32 mm with Safe Corners
 - 1.50" / 38 mm
 - 1.77" / 45 mm
 - 1.81" / 46 mm
- Fire Resistant Snap Frames
- Window Frames
 - 1" / 25 mm
 - 1.25" / 32 mm
- Double Sided Snap Frames
- Security Frames
 - 1" / 25 mm
 - 1.65" / 42 mm
- Lockable Snap Frames
- Double Color Frames
- Paperboard
- Magnetic Frames



Snap Frames

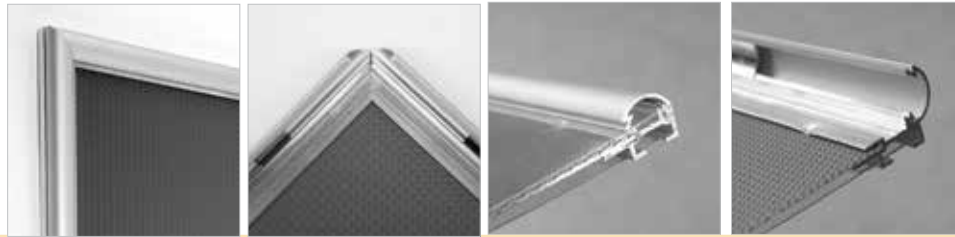

- 0.59" / 15 mm Profile, 45°**
- Ideal for small-sized posters.
 - Natural silver anodized and black colors available.
 - Mitered corners.
 - Anti-glare poster cover sheet.

Each frame includes wall mounting accessories (4 screws & 4 plugs).

! Suitable for silk screen printing, max. letter height is 0,31.

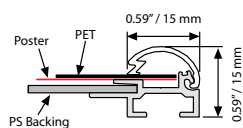
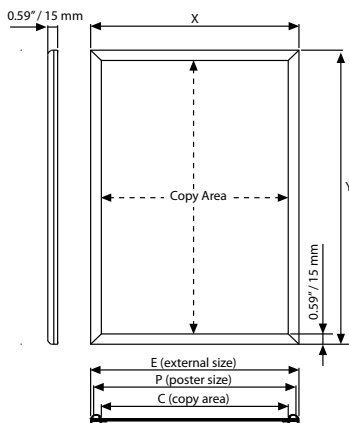

MATERIAL : Silver anodized aluminum					WEIGHT	PACKING SIZE
ARTICLE	DESCRIPTION	EXTERNAL (x-y)	POSTER	COPY	WITH PACKING	*W X H X D
UCN155N081	Silver	8.90" X 11.38"	8.5" X 11"	7.72" X 10.20"	1.102 lbs	10.63" X 12.99" X 0.83"
UCN155N017	Silver	11.38" X 17.40"	11" X 17"	10.20" X 16.22"	1.873 lbs	12.99" X 18.90" X 0.83"
UCN155N014	Silver	14.41" X 22.40"	14" X 22"	13.23" X 21.22"	2.711 lbs	16.54" X 24.41" X 0.83"
UCN155N016	Silver	16.42" X 20.39"	16" X 20"	15.24" X 19.21"	2.425 lbs	18.50" X 22.44" X 0.83"
UCN155N012	Silver	17.40" X 22.40"	17" X 22"	16.22" X 21.22"	2.711 lbs	18.50" X 22.44" X 0.83"
UCN155N018	Silver	18.43" X 24.41"	18" X 24"	17.24" X 23.23"	2.645 lbs	20.08" X 25.98" X 0.83"
UCN155N023	Silver	20.39" X 30.39"	20" X 30"	19.21" X 29.21"	3.637 lbs	22.44" X 32.28" X 0.91
UCN155B081	Black	8.90" X 11.38"	8.5" X 11"	7.72" X 10.20"	1.102 lbs	10.63" X 12.99" X 0.83"
UCN155B017	Black	11.38" X 17.40"	11" X 17"	10.20" X 16.22"	1.873 lbs	12.99" X 18.90" X 0.83"

*W:Width H:Height D:Depth





Snap Frames



- 0.79" / 20 mm Profile, 45°**
- Ideal for small-sized posters.
 - Natural silver anodized and black colors available.
 - Mitered corners.
 - Anti-glare poster cover sheet.

 Each frame includes wall mounting accessories (4 screws & 4 plugs).

 "Optional hangers" permit easy mounting.

 Suitable for silk screen printing, max. letter height is 0.43.



UYUP057000
Counter support
available. Suitable for
both landscape&portrait.



UYAA011010
V hanger

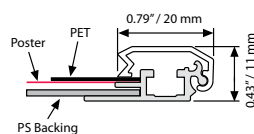
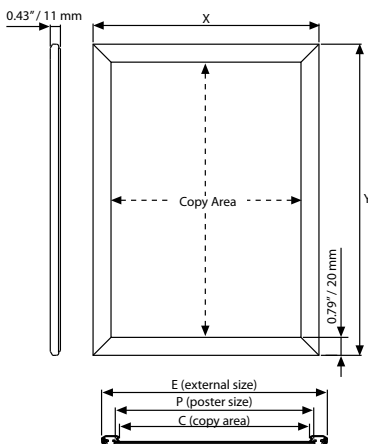

MATERIAL : Silver anodized aluminum				WEIGHT	PACKING SIZE
ARTICLE	EXTERNAL (x-y)	POSTER	COPY	WITH PACKING	*W X H X D
UCN205N081	9.69" X 12.17"	8.5" X 11"	8.19" X 10.67"	1.102 lbs	10.63" X 12.99" X 0.83"
UCN205N017	12.17" X 18.19"	11" X 17"	10.67" X 16.69"	1.873 lbs	12.99" X 18.90" X 0.83"
UCN205N012	18.19" X 23.19"	17" X 22"	16.69" X 21.69"	2.711 lbs	19.29" X 24.41" X 0.83"
UCN205N018	19.21" X 25.20"	18" X 24"	17.72" X 23.70"	2.645 lbs	20.08" X 25.98" X 0.83"
UCN205N013	19.21" X 31.18"	18" X 30"	17.72" X 29.69"	3.637 lbs	20.47" X 32.28" X 0.83"
UCN155N023	21.18" X 31.18"	20" X 30"	19.69" X 29.69"	3.637 lbs	22.05" X 31.89" X 0.91"
UCN155N034	31.18" X 41.18"	30" X 40"	29.69" X 39.69"	6.944 lbs	31.89" X 42.13" X 0.91"

* W:Width H: Height D: Depth





Snap Frames



1" / 25 mm Profile, 45° - Round

- Ideal for posters of every size.
- Natural silver anodized and black colors available.
- Mitered and Round corner alternatives.
- Anti-glare poster cover sheet.

 Each frame includes wall mounting accessories (4 screws & 4 plugs).

 "Optional hangers" permit easy mounting.

 Suitable for silk screen printing, max. letter height is 0.59".



UYAA011010
V hanger



UYUP057000
Counter support available. Suitable for both landscape & portrait.

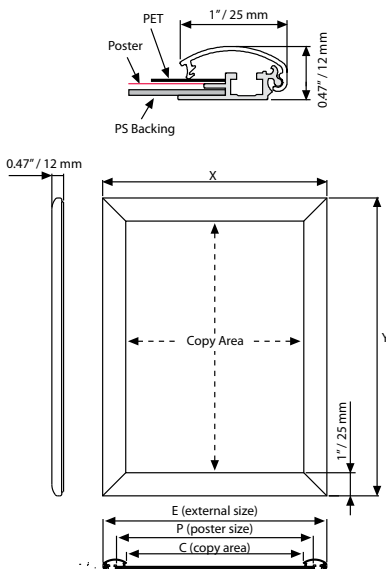

MATERIAL : Silver anodized aluminum							WEIGHT	PACKING SIZE
SILVER MITRED	BLACK MITRED	SILVER ROUND	BLACK ROUND	EXTERNAL (x-y)	POSTER	COPY	WITH PACKING	*W X H X D
UCN255N057	-	-	-	6.18" X 8.19"	5" X 7"	4.29" X 6.30"	0.551 lbs	7.48" X 9.45" X 0.83"
UCN255N009	-	-	-	7.20" X 10.20"	6" X 9"	5.31" X 8.31"	0.771 lbs	8.27" X 9.06" X 0.83"
UCN255N010	-	-	-	9.17" X 11.18"	8" X 10"	7.28" X 9.29"	0.837 lbs	10.63" X 12.20" X 0.83"
UCN255N081	-	-	-	9.69" X 12.17"	8.5" X 11"	7.80" X 10.28"	1.102 lbs	10.63" X 12.20" X 0.83"
UCN255N011	-	-	-	12.17" X 15.20"	11" X 14"	10.28" X 13.31"	1.433 lbs	13.39" X 16.54" X 0.83"
UCN255N017	UCN255B017	UCN250N017	UCN250B017	12.17" X 18.19"	11" X 17"	10.28" X 16.30"	1.873 lbs	12.99" X 18.90" X 0.83"
UCN255N014	UCN255B014	-	-	15.20" X 23.19"	14" X 22"	13.31" X 21.30"	2.711 lbs	16.54" X 24.41" X 0.83"
UCN255N016	UCN255B016	UCN250N016	UCN250B016	17.20" X 21.18"	16" X 20"	15.31" X 19.29"	2.425 lbs	18.50" X 22.44" X 0.83"
UCN255N018	UCN255B018	UCN250N018	UCN250B018	19.21" X 25.50"	18" X 24"	17.32" X 23.31"	2.645 lbs	20.08" X 25.98" X 0.83"
UCN255N023	UCN255B023	UCN250N023	UCN250B023	21.18" X 31.18"	20" X 30"	19.29" X 29.29"	3.637 lbs	22.05" X 31.89" X 0.91"
UCN255N022	UCN255B022	UCN250N022	UCN250B022	23.19" X 29.17"	22" X 28"	21.30" X 27.28"	3.637 lbs	24.02" X 30.31" X 0.83"
UCN255N024	UCN255B024	UCN250N024	UCN250B024	25.20" X 37.17"	24" X 36"	23.31" X 35.28"	5.070 lbs	25.98" X 35.58" X 0.83"
UCN255N074	-	-	-	28.19" X 41.18"	27" X 40"	26.30" X 39.29"	6.613 lbs	29.53" X 42.13" X 0.83"
UCN255N034	UCN255B034	UCN250N034	UCN250B034	31.18" X 41.18"	30" X 40"	29.29" X 39.29"	6.945 lbs	31.89" X 42.13" X 0.91"
UCN255N046	-	UCN250N046	-	41.18" X 61.18"	40" X 60"	39.29" X 59.29"	13.227 lbs	41.73" X 61.81" X 0.91"



* W:Width H: Height D: Depth

Snap Frames

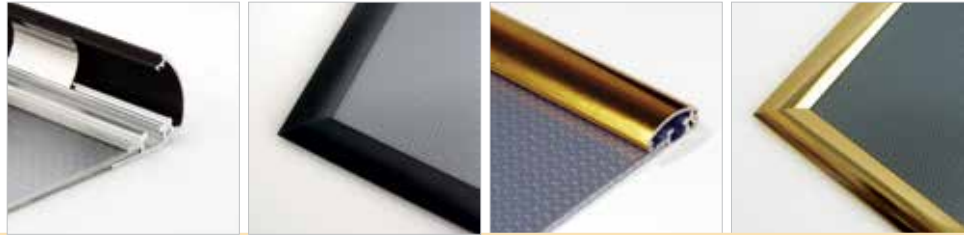



1" / 25 mm Profile, 45° Gold Look Effect

- Attractive brightness on the profile.
- Ideal for posters of every size.
- Mitered corners.
- Anti-glare poster cover sheet.

1" / 25 mm Profile, 45° Black Anodized

- Attractive black anodized effect on the profile.
- Ideal for posters of every size.
- Mitered corners.
- Anti-glare poster cover sheet.

 Each frame includes wall mounting accessories (4 screws & 4 plugs).

 'Optional hangers' permit easy mounting.



Gold



Black



UYAA011010
V hanger



UYUP057000
Counter support
available. Suitable for
both landscape&portrait.

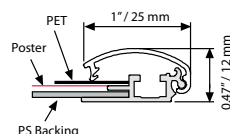
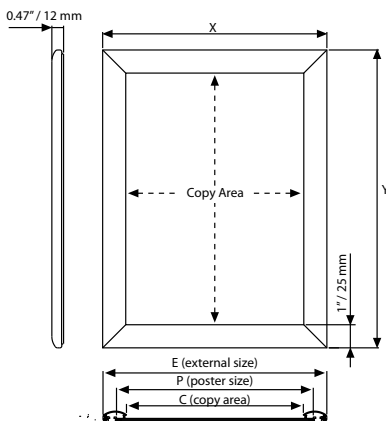

MATERIAL : Silver anodized aluminum					WEIGHT	PACKING SIZE
BLACK	GOLD	EXTERNAL (x-y)	POSTER	COPY	WITH PACKING	*W X H X D
UCN255B057	-	6.18" X 8.19"	5" X 7"	4.29" X 6.30"	0.551 lbs	7.48" X 9.45" X 0.83"
UCN255B009	UCN255G009	7.20" X 10.20"	6" X 9"	5.31" X 8.31"	0.771 lbs	8.27" X 9.06" X 0.83"
UCN255B010	-	9.17" X 11.18"	8" X 10"	7.28" X 9.29"	0.837 lbs	10.63" X 12.20" X 0.83"
UCN255B081	UCN255G081	9.69" X 12.17"	8.5" X 11"	7.80" X 10.28"	1.102 lbs	10.63" X 12.20" X 0.83"
UCN255B011	-	12.17" X 15.20"	11" X 14"	10.28" X 13.31"	1.433 lbs	13.39" X 16.54" X 0.83"
UCN255B017	-	12.17" X 18.19"	11" X 17"	10.28" X 16.30"	1.873 lbs	12.99" X 18.90" X 0.83"
UCN255B014	-	15.20" X 23.19"	14" X 22"	13.31" X 21.30"	2.711 lbs	16.54" X 24.41" X 0.83"
UCN255B016	-	17.20" X 21.18"	16" X 20"	15.31" X 19.29"	2.425 lbs	18.50" X 22.44" X 0.83"
UCN255B018	-	19.21" X 25.50"	18" X 24"	17.32" X 23.31"	2.645 lbs	20.08" X 25.98" X 0.83"
UCN255B023	UCN255G023	21.18" X 31.18"	20" X 30"	19.29" X 29.29"	3.637 lbs	22.05" X 31.89" X 0.91"
UCN255B022	-	23.19" X 29.17"	22" X 28"	21.30" X 27.28"	3.637 lbs	24.02" X 30.31" X 0.83"
UCN255B024	-	25.20" X 37.17"	24" X 36"	23.31" X 35.28"	5.070 lbs	25.98" X 35.58" X 0.83"
UCN255B074	-	28.19" X 41.18"	27" X 40"	26.30" X 39.29"	6.613 lbs	29.53" X 42.13" X 0.83"
UCN255B034	UCN255G034	31.18" X 41.18"	30" X 40"	29.29" X 39.29"	6.945 lbs	31.89" X 42.13" X 0.91"
UCN255B046	UCN255G046	41.18" X 61.18"	40" X 60"	39.29" X 59.29"	13.227 lbs	41.73" X 61.81" X 0.91"

* W:Width H: Height D: Depth



Snap Frames





1" / 25 mm Profile, 45° Chrome Look

- Attractive chrome brightness on the profile.
- Ideal for posters of every size.
- Mitered corners.
- Anti-glare poster cover sheet.

1" / 25 mm Profile, 45° Stainless Steel Look

- Attractive stainless steel look on the profile.
- Ideal for posters of every size.
- Mitered corners.
- Anti-glare poster cover sheet.

 Each frame includes wall mounting accessories (4 screws & 4 plugs).

 "Optional hangers" permit easy mounting.



Chrome Look Effect



Stainless Steel Look



UYAA011010
V hanger



UYUP057000
Counter support
available. Suitable for
both landscape&portrait.

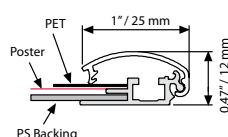
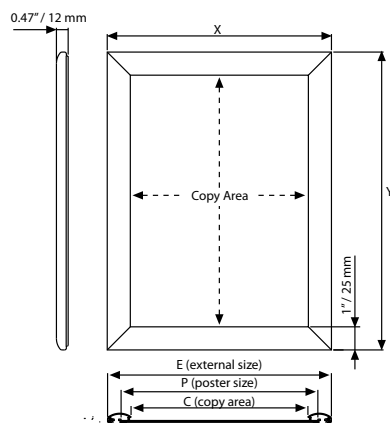

MATERIAL : Chrome Look Effect / Stainless Steel Look					WEIGHT	PACKING SIZE
CHROME	STAINLESS	EXTERNAL (x-y)	POSTER	COPY	WITH PACKING	*W X H X D
UCN255K057	UCN255S057	6.18" X 8.19"	5" X 7"	4.29" X 6.30"	0.551 lbs	7.48" X 9.45" X 0.83"
UCN255K009	UCN255S009	7.20" X 10.20"	6" X 9"	5.31" X 8.31"	0.771 lbs	8.27" X 9.06" X 0.83"
UCN255K010	UCN255S010	9.17" X 11.18"	8" X 10"	7.28" X 9.29"	0.837 lbs	10.63" X 12.20" X 0.83"
UCN255K081	UCN255S081	9.69" X 12.17"	8.5" X 11"	7.80" X 10.28"	1.102 lbs	10.63" X 12.20" X 0.83"
UCN255K011	UCN255S011	12.17" X 15.20"	11" X 14"	10.28" X 13.31"	1.433 lbs	13.39" X 16.54" X 0.83"
UCN255K017	UCN255S017	12.17" X 18.19"	11" X 17"	10.28" X 16.30"	1.873 lbs	12.99" X 18.90" X 0.83"
UCN255K014	UCN255S014	15.20" X 23.19"	14" X 22"	13.31" X 21.30"	2.711 lbs	16.54" X 24.41" X 0.83"
UCN255K016	UCN255S016	17.20" X 21.18"	16" X 20"	15.31" X 19.29"	2.425 lbs	18.50" X 22.44" X 0.83"
UCN255K018	UCN255S018	19.21" X 25.50"	18" X 24"	17.32" X 23.31"	2.645 lbs	20.08" X 25.98" X 0.83"
UCN255K023	UCN255S023	21.18" X 31.18"	20" X 30"	19.29" X 29.29"	3.637 lbs	22.05" X 31.89" X 0.91"
UCN255K022	UCN255S022	23.19" X 29.17"	22" X 28"	21.30" X 27.28"	3.637 lbs	24.02" X 30.31" X 0.83"
UCN255K024	UCN255S024	25.20" X 37.17"	24" X 36"	23.31" X 35.28"	5.070 lbs	25.98" X 35.58" X 0.83"
UCN255K074	UCN255S074	28.19" X 41.18"	27" X 40"	26.30" X 39.29"	6.613 lbs	29.53" X 42.13" X 0.83"
UCN255K034	UCN255S034	31.18" X 41.18"	30" X 40"	29.29" X 39.29"	6.945 lbs	31.89" X 42.13" X 0.91"
UCN255K046	UCN255S046	41.18" X 61.18"	40" X 60"	39.29" X 59.29"	13.227 lbs	41.73" X 61.81" X 0.91"

*W:Width H: Height D: Depth



Snap Frames



1" / 25 mm Profile, 45°

Wood Look Effect

- Attractive wooden finish effect on the profile.
- Ideal for posters of every size.
- Mitered corners.
- Anti-glare poster cover sheet.

1" / 25 mm Profile, 45°

Light Wood Effect

- Attractive light wood finish effect on the profile.
- Ideal for posters of every size.
- Mitered corners.
- Anti-glare poster cover sheet.



Each frame includes wall mounting accessories (4 screws & 4 plugs).



"Optional hangers" permit easy mounting.



Suitable for silk screen printing, max. letter height is 0.59".

Color options



Dark Wood Light Wood



Wood Effect



Light Wood Effect



UYAA011010
V hanger



UYUP057000
Counter support
available. Suitable for
both landscape&portrait.

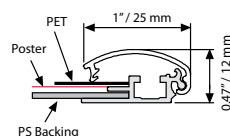
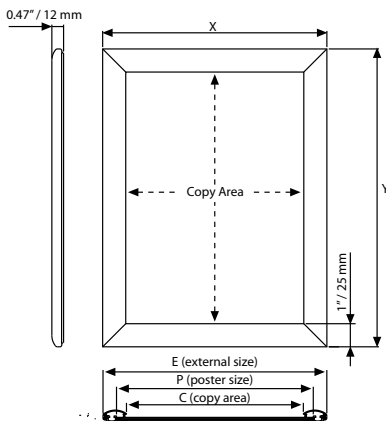

MATERIAL : Silver anodized aluminum					WEIGHT	PACKING SIZE
WOOD	LIGHT WOOD	EXTERNAL (x-y)	POSTER	COPY	WITH PACKING	*W X H X D
UCN255W057	UCN255W157	6.18" X 8.19"	5" X 7"	4.29" X 6.30"	0.551 lbs	7.48" X 9.45" X 0.83"
UCN255W009	UCN255W109	7.20" X 10.20"	6" X 9"	5.31" X 8.31"	0.771 lbs	8.27" X 9.06" X 0.83"
UCN255W010	UCN255W110	9.17" X 11.18"	8" X 10"	7.28" X 9.29"	0.837 lbs	10.63" X 12.20" X 0.83"
UCN255W081	UCN255W181	9.69" X 12.17"	8.5" X 11"	7.80" X 10.28"	1.102 lbs	10.63" X 12.20" X 0.83"
UCN255W011	UCN255W111	12.17" X 15.20"	11" X 14"	10.28" X 13.31"	1.433 lbs	13.39" X 16.54" X 0.83"
UCN255W017	UCN255W117	12.17" X 18.19"	11" X 17"	10.28" X 16.30"	1.873 lbs	12.99" X 18.90" X 0.83"
UCN255W014	UCN255W114	15.20" X 23.19"	14" X 22"	13.31" X 21.30"	2.711 lbs	16.54" X 24.41" X 0.83"
UCN255W016	UCN255W116	17.20" X 21.18"	16" X 20"	15.31" X 19.29"	2.425 lbs	18.50" X 22.44" X 0.83"
UCN255W018	UCN255W118	19.21" X 25.50"	18" X 24"	17.32" X 23.31"	2.645 lbs	20.08" X 25.98" X 0.83"
UCN255W023	UCN255W123	21.18" X 31.18"	20" X 30"	19.29" X 29.29"	3.637 lbs	22.05" X 31.89" X 0.91"
UCN255W022	UCN255W122	23.19" X 29.17"	22" X 28"	21.30" X 27.28"	3.637 lbs	24.02" X 30.31" X 0.83"
UCN255W024	UCN255W124	25.20" X 37.17"	24" X 36"	23.31" X 35.28"	5.070 lbs	25.98" X 35.58" X 0.83"
UCN255W074	UCN255W174	28.19" X 41.18"	27" X 40"	26.30" X 39.29"	6.613 lbs	29.53" X 42.13" X 0.83"
UCN255W034	UCN255W134	31.18" X 41.18"	30" X 40"	29.29" X 39.29"	6.945 lbs	31.89" X 42.13" X 0.91"
UCN255W046	UCN255W146	41.18" X 61.18"	40" X 60"	39.29" X 59.29"	13.227 lbs	41.73" X 61.81" X 0.91"

*W:Width H: Height D: Depth



Coloured Snap Frames

new



1" / 25 mm Profile, 45°

Coloured Snap Frames

- Powdercoated silky finish
- Ideal for posters of every size.
- Mitred corners.
- Anti-glare poster cover sheet

Each frame includes wall mounting accessories (4 screws & 4 plugs). Each frame is packed individually in a cardboard box.

Custom sizes are available.

Optional hangers permit easy mounting.



Black - RAL 9005



White - RAL9003



Red - RAL 3020



UYAA011010
V hanger / Aufhänger



UYUP057000
Counter support
available. Suitable for
both landscape&portrait.

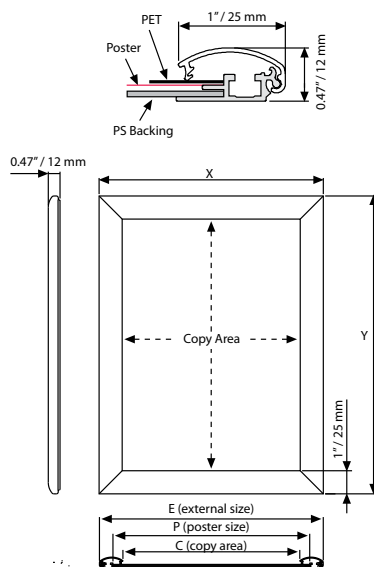

MATERIAL : Powdercoated Silky Finish						WEIGHT	PACKING SIZE
RED	WHITE	BLACK	EXTERNAL (x-y)	POSTER	COPY	WITH PACKING	*W X H X D
UCN2553057	UCN2552057	UCN2551057	6.18" X 8.19"	5" X 7"	4.29" X 6.30"	0.551 lbs	7.48" X 9.45" X 0.83"
UCN2553009	UCN2552009	UCN2551009	7.20" X 10.20"	6" X 9"	5.31" X 8.31"	0.771 lbs	8.27" X 9.06" X 0.83"
UCN2553010	UCN2552010	UCN2551010	9.17" X 11.18"	8" X 10"	7.28" X 9.29"	0.837 lbs	10.63" X 12.20" X 0.83"
UCN2553081	UCN2552081	UCN2551081	9.69" X 12.17"	8.5" X 11"	7.80" X 10.28"	1.102 lbs	10.63" X 12.20" X 0.83"
UCN2553011	UCN2552011	UCN2551011	12.17" X 15.20"	11" X 14"	10.28" X 13.31"	1.433 lbs	13.39" X 16.54" X 0.83"
UCN2553017	UCN2552017	UCN2551017	12.17" X 18.19"	11" X 17"	10.28" X 16.30"	1.873 lbs	12.99" X 18.90" X 0.83"
UCN2553014	UCN2552014	UCN2551014	15.20" X 23.19"	14" X 22"	13.31" X 21.30"	2.711 lbs	16.54" X 24.41" X 0.83"
UCN2553016	UCN2552016	UCN2551016	17.20" X 21.18"	16" X 20"	15.31" X 19.29"	2.425 lbs	18.50" X 22.44" X 0.83"
UCN2553018	UCN2552018	UCN2551018	19.21" X 25.50"	18" X 24"	17.32" X 23.31"	2.645 lbs	20.08" X 25.98" X 0.83"
UCN2553023	UCN2552023	UCN2551023	21.18" X 31.18"	20" X 30"	19.29" X 29.29"	3.637 lbs	22.05" X 31.89" X 0.91"
UCN2553022	UCN2552022	UCN2551022	23.19" X 29.17"	22" X 28"	21.30" X 27.28"	3.637 lbs	24.02" X 30.31" X 0.83"
UCN2553024	UCN2552024	UCN2551024	25.20" X 37.17"	24" X 36"	23.31" X 35.28"	5.070 lbs	25.98" X 35.58" X 0.83"
UCN2553074	UCN2552074	UCN2551074	28.19" X 41.18"	27" X 40"	26.30" X 39.29"	6.613 lbs	29.53" X 42.13" X 0.83"
UCN2553034	UCN2552034	UCN2551034	31.18" X 41.18"	30" X 40"	29.29" X 39.29"	6.945 lbs	31.89" X 42.13" X 0.91"
UCN2553046	UCN2552046	UCN2551046	41.18" X 61.18"	40" X 60"	39.29" X 59.29"	13.227 lbs	41.73" X 61.81" X 0.91"

*W:Width H:Height D:Depth





Snap Frames



1.18" / 30 mm Profile, 45° - Round

- Ideal for posters of every size.
- Natural silver anodized and black colors available.
- Mitered and Round corner alternatives.
- Anti-glare poster cover sheet.

 Each frame includes wall mounting accessories (4 screws & 4 plugs).

 "Optional hangers" permit easy mounting.

 Suitable for silk screen printing, max. letter height is 0.79".



UYAA011010
V hanger

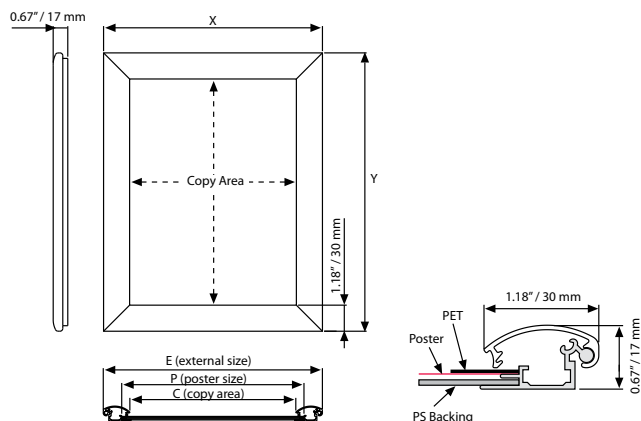

MATERIAL : Silver anodized aluminum					WEIGHT	PACKING SIZE
MITRED	ROUND	EXTERNAL (x-y)	POSTER	COPY	WITH PACKING	*W X H X D
UCN305N057	UCN300N057	6.69" X 8.69"	5" X 7"	4.41" X 6.41"	0.970 lbs	11.30" X 9.37" X 1.22"
UCN305N009	UCN300N009	7.69" X 10.69"	6" X 9"	5.41" X 8.41"	1.168 lbs	8.39" X 11.38" X 1.22"
UCN305N010	UCN300N010	9.69" X 11.69"	8" X 10"	7.41" X 9.41"	1.366 lbs	10.39" X 12.36" X 1.22"
UCN305N081	UCN300N081	10.19" X 12.69"	8.5" X 11"	7.91" X 10.41"	1.410 lbs	10.87" X 13.39" X 1.22"
UCN305N014	UCN300N014	12.69" X 15.69"	11" X 14"	10.41" X 13.41"	1.829 lbs	13.39" X 16.38" X 1.22"
UCN305N017	UCN300N017	12.69" X 18.69"	11" X 17"	10.41" X 16.41"	2.050 lbs	13.39" X 19.37" X 1.22"
UCN305N012	UCN300N012	15.69" X 23.69"	14" X 22"	13.41" X 21.41"	3.042 lbs	16.38" X 24.37" X 1.22"
UCN305N016	UCN300N016	17.69" X 21.69"	16" X 20"	15.41" X 19.41"	3.042 lbs	18.39" X 22.36" X 1.22"
UCN305N018	UCN300N018	19.69" X 25.69"	18" X 24"	17.41" X 23.41"	3.791 lbs	20.39" X 26.38" X 1.22"
UCN305N023	UCN300N023	21.69" X 31.69"	20" X 30"	19.41" X 29.41"	4.519 lbs	22.44" X 32.28" X 1.22"
UCN305N022	UCN300N022	23.69" X 29.69"	22" X 28"	21.41" X 27.41"	4.629 lbs	24.37" X 30.39" X 1.22"
UCN305N024	UCN300N024	25.69" X 37.69"	24" X 36"	23.41" X 35.41"	6.812 lbs	26.38" X 38.39" X 1.22"
UCN305N074	UCN300N074	28.69" X 41.69"	27" X 40"	26.41" X 39.41"	7.583 lbs	29.37" X 42.36" X 1.22"
UCN305N034	UCN300N034	31.69" X 41.69"	30" X 40"	29.41" X 39.41"	7.936 lbs	32.28" X 42.52" X 1.22"
UCN305N046	UCN300N046	41.69" X 61.69"	40" X 60"	39.41" X 59.41"	14.881 lbs	41.73" X 61.81" X 1.22"

*W:Width H:Height D:Depth



Snap Frames

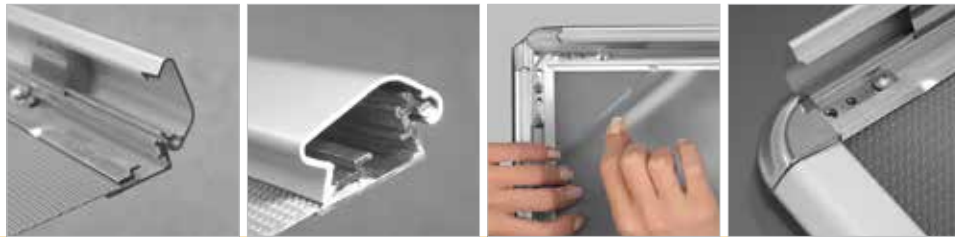

1.25" / 32 mm Profile, 45° - Round

- Ideal for posters of every size.
- Natural silver anodized and black colors available.
- Mitered and Round corner alternatives.
- Anti-glare poster cover sheet.



Each frame includes wall mounting accessories (4 screws & 4 plugs).



"Optional hangers" permit easy mounting.



Suitable for silk screen printing, max. letter height is 0.63".



UYAA011010
V hanger

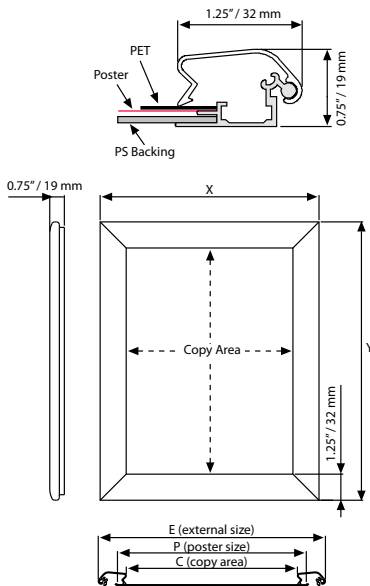

MATERIAL : Silver anodized aluminum							WEIGHT	PACKING SIZE
SILVER MITRED	BLACK MITRED	SILVER ROUND	BLACK ROUND	EXTERNAL (x-y)	POSTER	COPY	WITH PACKING	*W X H X D
UCN325N057	-	-	-	6.69" X 8.70"	5" X 7"	4.21" X 6.22"	0.705 lbs	8.27" X 9.84" X 1.22"
UCN325N010	-	-	-	9.69" X 11.69"	8" X 10"	7.20" X 9.21"	1.322 lbs	10.63" X 12.99" X 1.22"
UCN325N081	-	-	-	10.20" X 12.68"	8.5" X 11"	7.72" X 10.20"	1.500 lbs	11.02" X 13.39" X 1.22"
UCN325N014	-	-	-	12.68" X 15.71"	11" X 14"	10.20" X 13.23"	1.873 lbs	13.78" X 17.32" X 1.22"
UCN325N017	-	-	-	12.68" X 18.70"	11" X 17"	10.20" X 16.22"	2.380 lbs	13.78" X 18.90" X 1.22"
UCN325N016	-	-	-	17.72" X 21.69"	16" X 20"	15.24" X 19.21"	2.755 lbs	18.50" X 22.44" X 1.22"
UCN325N018	-	UCN320N018	UCN320B018	19.72" X 25.71"	18" X 24"	17.24" X 23.23"	3.306 lbs	20.47" X 26.38" X 1.22"
UCN325N023	-	-	-	21.69" X 31.69"	20" X 30"	19.21" X 29.21"	4.519 lbs	22.44" X 32.28" X 1.22"
UCN325N022	-	-	-	23.70" X 29.69"	22" X 28"	21.22" X 27.20"	5.732 lbs	24.41" X 30.71" X 1.22"
UCN325N024	-	UCN320N023	-	25.71" X 37.68"	24" X 36"	23.23" X 35.20"	5.621 lbs	26.77" X 38.58" X 1.22"
UCN325N074	-	-	-	27.80" X 41.69"	27" X 40"	26.22" X 39.21"	7.275 lbs	29.53" X 42.13" X 1.22"
UCN325N036	UCN325B036	-	-	37.72" X 49.72"	36" X 48"	35.24" X 47.24"	9.920 lbs	36.61" X 48.82" X 1.22"
UCN325N034	-	UCN320N034	-	31.69" X 41.69"	30" X 40"	29.21" X 39.21"	7.936 lbs	32.28" X 42.52" X 1.22"
UCN325N046	UCN325B046	UCN320N046	-	41.69" X 61.69"	40" X 60"	39.21" X 59.21"	14.881 lbs	41.73" X 61.81" X 1.22"



*W:Width H: Height D: Depth

Snap Frame 1.25" / 32 mm with Safe Corners



1.25" / 32 mm Profile, 45° - Safe Corners

- Ideal for posters of every size.
- Natural silver anodized and black colors available.
- Mitered and Round corner alternatives.
- Anti-glare poster cover sheet.



Each frame includes wall mounting accessories (4 screws & 4 plugs).



"Optional hangers" permit easy mounting.



Suitable for silk screen printing, max. letter height is 0.63".



Safe edges



UYAA011010
V hanger

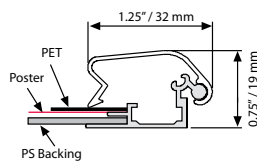
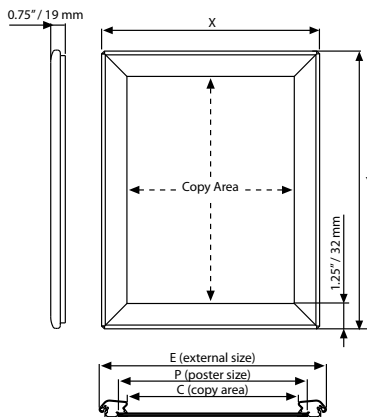

MATERIAL : Silver anodized aluminum					WEIGHT	PACKING SIZE
SILVER	BLACK	EXTERNAL (x-y)	POSTER	COPY	WITH PACKING	*W X H X D
UCN321N018	UCN321B018	19.72" X 25.71"	18" X 24"	17.24" X 23.23"	3.306 lbs	20.47" X 26.38" X 1.22"
UCN321N023	UCN321B023	21.69" X 31.69"	20" X 30"	19.41" X 29.41"	4.519 lbs	22.44" X 32.28" X 1.22"
UCN321N022	UCN321B022	23.70" X 29.69"	22" X 28"	21.22" X 27.20"	5.732 lbs	24.41" X 30.71" X 1.22"
UCN321N024	UCN321B024	25.71" X 37.68"	24" X 36"	23.23" X 35.20"	5.621 lbs	26.77" X 38.58" X 1.22"
UCN321N074	UCN321B074	28.70" X 41.69"	27" X 40"	26.22" X 39.21"	7.275 lbs	29.53" X 42.13" X 1.22"
UCN321N034	UCN321B034	31.69" X 41.69"	30" X 40"	29.41" X 39.41"	7.936 lbs	32.28" X 42.52" X 1.22"
UCN321N046	UCN321B046	41.69" X 61.69"	40" X 60"	39.41" X 59.41"	14.881 lbs	41.73" X 61.81" X 1.22"

* W:Width H: Height D: Depth



Snap Frames

1.50" / 38 mm

1.77" / 45 mm



- Ideal for large-scale posters.
- Natural silver anodized and black colors available.
- Mitered corners.
- Anti-glare poster cover sheet.

Each frame includes wall mounting accessories (4 screws & 4 plugs). Each frame is packed individually in a cardboard box.

"Optional hangers" permit easy mounting.

Suitable for silk screen printing, max. letter height is 0.79" for 1.50". Suitable for silk screen printing, max. letter height is 1" for 1.77".



1.50" / 38mm



1.77" / 45 mm



UYAA011010
V hanger

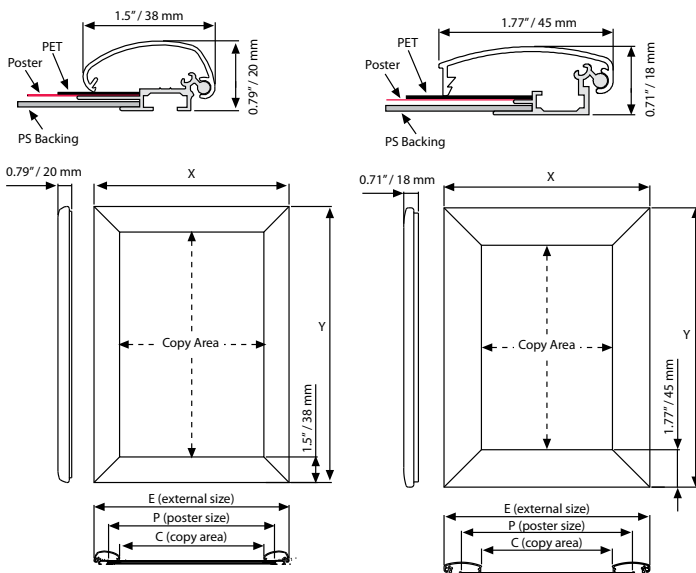

1.50" / 38 mm Profile, 45° : Silver anodized aluminum				WEIGHT	PACKING SIZE
ARTICLE	EXTERNAL (x-y)	POSTER	COPY	WITH PACKING	*W X H X D
UCN385G081	10.27" X 12.77"	8.5" X 11"	7.28" X 9.78"	1.719 lbs	10.87" X 12.39" X 1.22"
UCN385G017	12.77" X 18.77"	11" X 17"	9.78" X 15.78"	2.226 lbs	13.39" X 19.37" X 1.22"
UCN385G023	21.77" X 31.77"	20" X 30"	18.78" X 28.78"	4.739 lbs	22.44" X 32.28" X 1.22"
UCN385G034	31.77" X 41.77"	30" X 40"	28.78" X 38.78"	8.421 lbs	32.28" X 42.52" X 1.22"
UCN385G046	41.77" X 61.77"	40" X 60"	38.78" X 58.78"	15.211 lbs	41.73" X 61.81" X 1.22"

1.77" / 45 mm Profile, 45° : Silver & black anodized aluminum				WEIGHT	PACKING SIZE	
SILVER	BLACK	EXTERNAL (x-y)	POSTER	COPY	WITH PACKING	*W X H X D
UCN455N023	UCN455B023	21.69" X 31.69"	20" X 30"	18.23" X 28.23"	4.739 lbs	22.44" X 32.28" X 1.22"
UCN455N034	UCN455B034	31.69" X 41.69"	30" X 40"	28.23" X 38.23"	9.149 lbs	32.28" X 42.25" X 1.22"
UCN455N046	UCN455B046	41.69" X 61.69"	40" X 60"	38.23" X 58.23"	15.873 lbs	41.73" X 61.81" X 1.22"
UCN455N074	UCN455B074	28.70" X 41.69"	27" X 40"	25.24" X 38.23"	7.716 lbs	29.53" X 42.13" X 1.22"
UCN455N036	UCN455B036	37.72" X 49.72"	36" X 48"	34.25" X 46.26"	9.920 lbs	36.61" X 48.82" X 1.22"

*W:Width H: Height D: Depth





Snap Frames



1.81" / 46 mm Profile, 45° - Round

- Ideal for large-scaled posters.
- Natural silver anodized and black colors available.
- Mitered and Round corner alternatives.
- Anti-glare poster cover sheet.

 Each frame includes wall mounting accessories (4 screws & 4 plugs).

 "Optional hangers" permit easy mounting.

 Suitable for silk screen printing, max. letter height is 1.10".



UYAA011010
V hanger

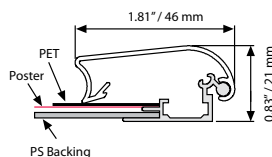
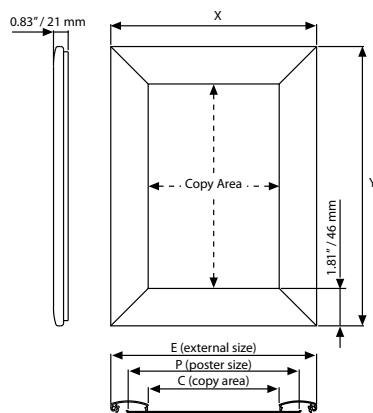

MATERIAL : Silver & black anodized aluminum					WEIGHT	PACKING SIZE
MITRED	ROUND	EXTERNAL (x-y)	POSTER	COPY	WITH PACKING	*W X H X D
UCN465N023	UCN460N023	21.69" X 31.69"	20" X 30"	18.23" X 28.23"	4.739 lbs	22.44" X 32.28" X 1.22"
UCN465N034	UCN460N034	31.69" X 41.69"	30" X 40"	28.23" X 38.23"	9.149 lbs	32.28" X 42.52" X 1.22"
UCN465N036	UCN460N036	37.69" X 49.69"	36" X 48"	34.23" X 46.23"	13.448 lbs	38.39" X 50.39" X 1.22"
UCN465N046	UCN460N046	41.69" X 61.69"	40" X 60"	38.23" X 58.23"	15.873 lbs	41.73" X 61.81" X 1.22"

*W:Width H: Height D: Depth



Fire Resistant Snap Frame 1" / 25 mm

new



See movie at our website www.mtdisplays.com.tr



1" / 25 mm Profile, 45°

- Fire classified for EN13501-1 Class B s1 d0, hardly inflammable (B1 rated for German DIN standards)
- 25mm wide silver anodised profile with mitred corners.
- B1 fire resistant anti-reflex poster protection.
- Perfect for educational, commercial and public places.

Fire Resistant Snap Frames supplied without screws and wall plugs.

No assembly required.



UYAA011010
Optional V hanger /
Aufhänger

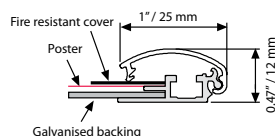
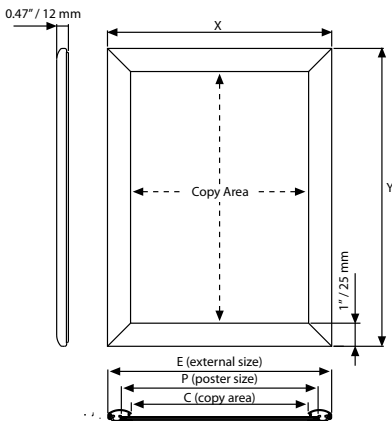

MATERIAL : Silver anodised aluminium				WEIGHT	PACKING SIZE
ARTICLE	EXTERNAL (x-y)	POSTER	COPY	WITH PACKING	*W X H X D
UCFR255N81	9.69" X 12.17"	8.5" X 11"	7.80" X 10.28"	1.455 lbs	10.63" X 12.20" X 0.83"
UCFR255N11	12.17" X 18.19"	11" X 17"	10.28" X 16.30"	2.358 lbs	12.99" X 18.90" X 0.83"
UCFR255N14	12.17" X 15.20"	11" X 14"	10.28" X 13.31"	2.270 lbs	13.39" X 16.54" X 0.83"
UCFR255N12	18.19" X 23.19"	17" X 22"	16.30" X 21.30"	5.070 lbs	18.98" X 24.01" X 0.83"
UCFR255N82	19.21" X 25.50"	18" X 24"	17.32" X 23.31"	5.401 lbs	20.08" X 25.98" X 0.83"
UCFR255N23	21.18" X 31.18"	20" X 30"	19.29" X 29.29"	5.908 lbs	22.05" X 31.89" X 0.91"
UCFR255N24	25.20" X 37.17"	24" X 36"	23.31" X 35.28"	8.289 lbs	25.98" X 38.18" X 0.83"
UCFR255N34	31.18" X 41.18"	30" X 40"	29.29" X 39.29"	14.175 lbs	31.89" X 42.13" X 0.91"



*W:Width H: Height D: Depth

Window Frames

1" / 25 mm - 1.25" / 32 mm



See movie at our website www.mtdisplays.com.tr



The Window Frame system is available in 1" and 1.25" profiles. You can easily change the poster by opening the front profile. 2 anti-reflex PET sheets cover posters. Can be displayed both indoor & outdoor. The system includes decorative back profile to hide the double-sided adhesive tape which holds the frame to the window. Anti-glare poster cover sheet.

Double PET cover, double-sided tape a round the frame internal & external.

Please clean the surface before applying the double-sided tape for better application. Suitable for silk screen printing, max. letter height is 0.59".



1" / 25 mm



1.25" / 32 mm

1.25" / 32 mm : Silver anodized aluminum					WEIGHT	PACKING SIZE
ARTICLE 1.18"	ARTICLE 1.25"	EXTERNAL (x-y)	POSTER	COPY	WITH PACKING	*W X H X D
UCW305N423	UCW325N423	21.69" X 31.69"	20" X 30"	19.21" X 29.21"	4.519 lbs	22.44" X 32.28" X 1.22"
UCW305N434	UCW325N434	31.69" X 41.69"	30" X 40"	29.21" X 39.21"	7.936 lbs	32.28" X 42.52" X 1.22"
UCW305N446	UCW325N446	41.69" X 61.69"	40" X 60"	39.21" X 59.21"	14.881 lbs	41.73" X 61.81" X 1.22"

1" / 25 mm : Silver anodized aluminum					WEIGHT	PACKING SIZE
SILVER	BLACK	EXTERNAL (x-y)	POSTER	COPY	WITH PACKING	*W X H X D
UCW255N481	UCW255B481	9.69" X 12.17"	8.5" X 11"	7.80" X 10.28"	1.102 lbs	10.63" X 12.99" X 0.83"
UCW255N417	UCW255B417	12.17" X 18.19"	11" X 17"	10.28" X 16.30"	1.873 lbs	12.99" X 18.90" X 0.83"
UCW255N422	UCW255B422	23.19" X 29.17"	22" X 28"	21.30" X 27.28"	3.637 lbs	24.02" X 30.31" X 0.83"
UCW255N423	UCW255B423	21.18" X 31.18"	20" X 30"	19.29" X 29.29"	3.637 lbs	22.44" X 32.28" X 1.22"
UCW255N434	UCW255B434	31.18" X 41.18"	30" X 40"	29.29" X 39.29"	6.944 lbs	31.89" X 42.13" X 0.91"
UCW255N446	UCW255B446	41.18" X 61.18"	40" X 60"	39.29" X 59.29"	13.227 lbs	41.73" X 61.81" X 0.91"

*W:Width H: Height D: Depth

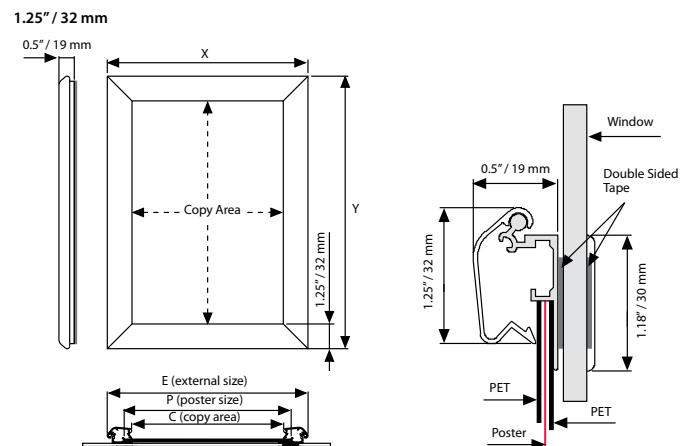
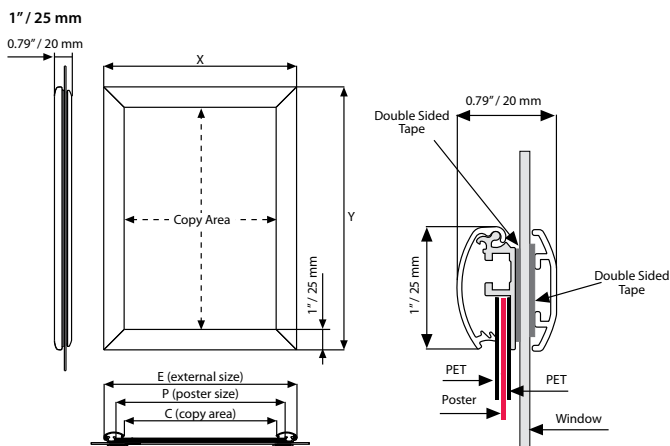

Lockable Window Frames

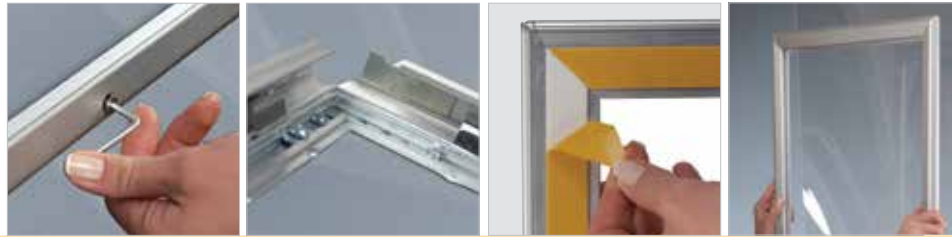

The lockable Window Frame system is available in a 1.25" profile. Thanks to 2 anti-reflex PET covers, your posters can be displayed both indoor & outdoor. The system includes a decorative back profile to hide the double-sided adhesive tape holding the frame up to the window. As the tape surrounds the whole frame, it prevents any water flow from the outside in order to keep your poster dry. The profiles open sequentially and the lockable system ensures your poster is never accessed by unauthorized third parties. Anti-glare poster cover sheet.

 Each Frame includes an allen key to open the locked profile. Double PET cover. Double-sided tape around the external backing of the frame for mounting.

 Please clean the surface before applying the double-sided tape for better application. Suitable for silk screen printing, max. letter height is 0.63".



Secured with allen key

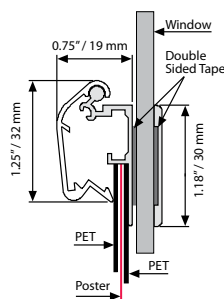
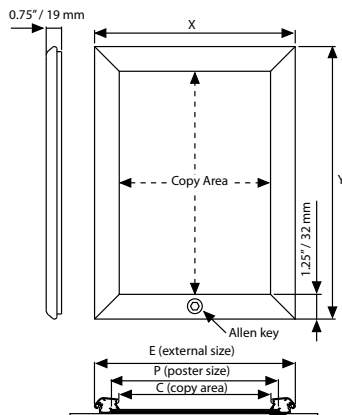

MATERIAL : Silver anodized aluminum				WEIGHT	PACKING SIZE
ARTICLE	EXTERNAL (x-y)	POSTER	COPY	WITH PACKING	*W X H X D
UCK325N423	21.69" X 31.69"	20" X 30"	19.21" X 29.21"	4.519 lbs	22.44" X 32.28" X 1.22"
UCK325N434	31.69" X 41.69"	30" X 40"	29.21" X 39.21"	7.936 lbs	32.28" X 42.52" X 1.22"
UCK325N446	41.69" X 61.69"	40" X 60"	39.21" X 59.21"	14.881 lbs	41.73" X 61.81" X 1.22"



* W:Width H: Height D: Depth

Fancy Frames



Fancy Frames with a snap open design are a simple to use framing system that makes changing graphics easy. The Fancy Frames come in different sizes and fit in decorative frames for use in a more classic and traditional setting.

Fancy frames come standard with anti-glare poster cover sheet.

 Each frame includes wall mounting accessories (4 screws & 4 plugs).

 "Optional hangers" permit easy mounting.

 Suitable for silk-screen printing max. letter height is 0.63".



Beige



Silver



Black

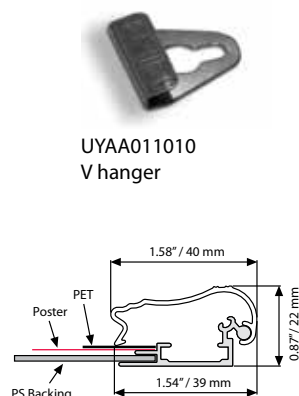
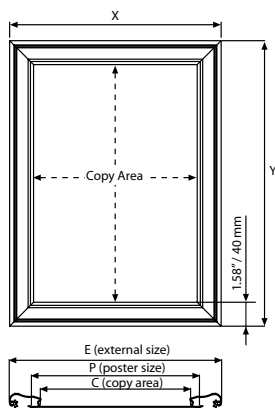

UYAA011010
V hanger

MATERIAL : Silver, Black and Beige anodized aluminum						WEIGHT	PACKING SIZE
SILVER	BLACK	BEIGE	EXTERNAL (x-y)	POSTER	COPY	WITH PACKING	*W X H X D
UCF405N022	UCF405B022	UCF405C022	26.18" X 38.15"	22" X 28"	21.14" X 27.13"	5.291 lbs	24.41" X 30.71" X 1.22"
UCF405N024	UCF405B024	UCF405C024	24.17" X 30.16"	24" X 36"	23.15" X 35.12"	5.732 lbs	26.77" X 38.58" X 1.22"



*W:Width H: Height D: Depth

Double Sided Snap Frames 1" / 25 mm



See movie at our website www.mtdisplays.com.tr



A suitable way to present your messages and posters in spaces where you have no wall mounting possibilities. If suspended from the ceiling via wire cables in front of shop windows, the posters can be viewed both from the inside and from the outside. Anti-glare poster cover sheet.

Each frame includes hanging hooks for suspension.

! All accessories are optional, not included in the original box. Suitable for silk screen printing, max. letter height is 0.47" - 0.55".

Optional accessories



Free hanging hooks come standard with frames.



Ceiling hangers are optional.

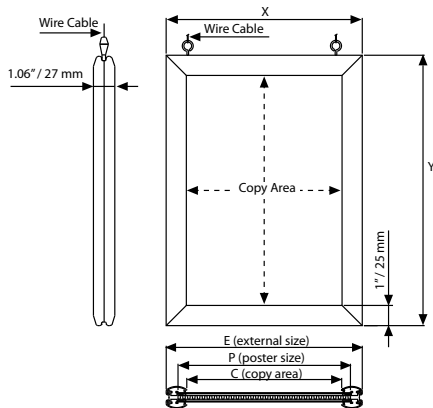

Hanging Kit
UYAA001030 for small sizes. (8.5"x11" to 24"x36")
UYAA001130 for big sizes. (27"x40" to 40"x60")
Hanger kit to be ordered separately.

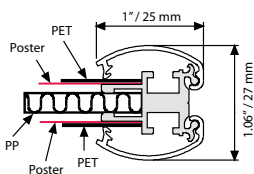

MATERIAL : Silver anodized aluminum				WEIGHT	PACKING SIZE
ARTICLE	EXTERNAL (x-y)	POSTER	COPY	WITH PACKING	*W X H X D
UCD255N281	9.68" X 12.18"	8.5" X 11"	7.79" X 10.29"	1.984 lbs	9.84" X 12.60" X 1.38"
UCD255N217	12.18" X 18.18"	11" X 17"	10.29" X 16.29"	3.196 lbs	12.60" X 18.90" X 1.38"
UCD255N222	23.18" X 29.18"	22" X 28"	21.29" X 27.29"	6.172 lbs	22.83" X 29.92" X 1.38"
UCD255N223	21.18" X 31.18"	20" X 30"	19.29" X 29.29"	7.936 lbs	22.44" X 32.28" X 1.38"
UCD255N224	25.18" X 37.18"	24" X 36"	23.29" X 35.29"	8.157 lbs	25.98" X 37.80" X 1.38"
UCD255N234	31.18" X 41.18"	30" X 40"	29.29" X 39.29"	10.361 lbs	32.28" X 42.52" X 1.38"
UCD255N246	41.18" X 61.18"	40" X 60"	39.29" X 59.29"	15.983 lbs	42.13" X 62.60" X 1.38"



*W:Width H: Height D: Depth

Security Frames

1"/25 mm - 1.65"/42 mm



- Ideal for medium-sized posters.
- It is a secure hard-to-open profile.
- Suitable for open-air use or highly frequented areas accessible to the public.
- Natural silver-anodized and various RAL colors are available.
- Anti-glare poster cover sheet.

 Each frame includes wall mounting accessories (4 screws & 4 plugs). Each frame is packed individually in a cardboard box.

 "Optional hangers" permit easy mounting.

 Suitable for silk screen printing, max. letter height is 0.59" for 1". Suitable for silk screen printing, max. letter height is 0.83" for 1.65". The lever tool should be ordered separately, not included in the original pack.



1" / 25 mm

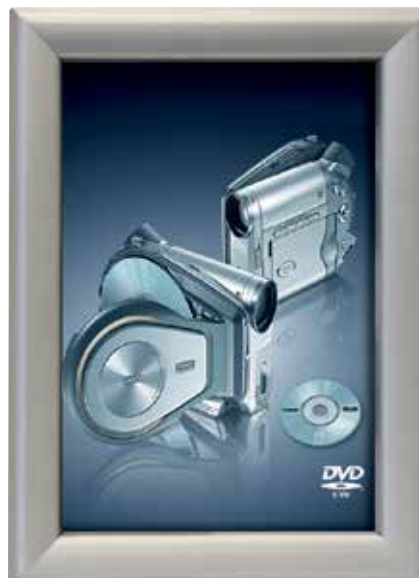

1.65" / 42 mm



UYAA011010
V hanger



UYUP047000
Levertool for 1.65"



UYUP047100
Levertool for 1"

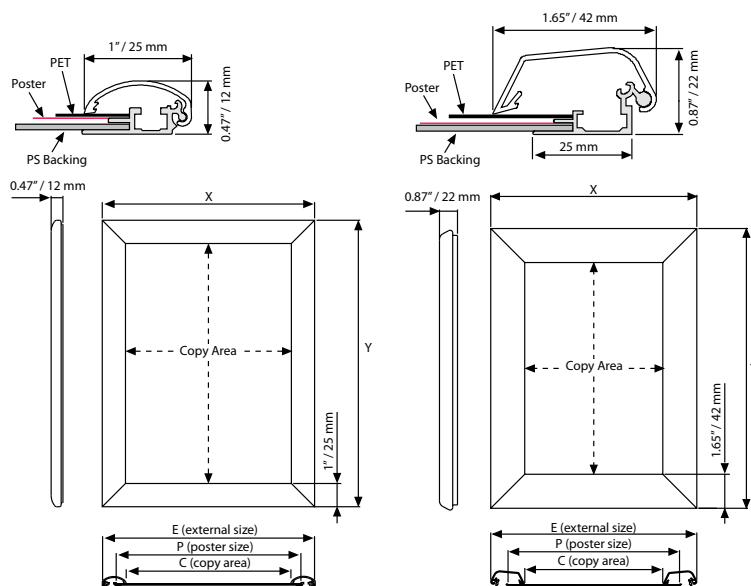

1" / 25 mm Profile, 45°: Silver anodized aluminum				WEIGHT	PACKING SIZE
ARTICLE	EXTERNAL (x-y)	POSTER	COPY	WITH PACKING	*W X H X D
UC2255N081	9.69" X 12.17"	8.5" X 11"	7.72" X 10.20"	1.102 lbs	10.63" X 12.99" X 0.83"
UC2255N022	23.19" X 29.17"	22" X 28"	21.22" X 27.20"	3.637 lbs	24.02" X 30.31" X 0.83"
UC2255N023	21.18" X 31.18"	20" X 30"	19.21" X 29.21"	3.637 lbs	22.44" X 32.28" X 1.22"
UC2255N024	25.20" X 37.17"	24" X 36"	23.23" X 35.20"	5.070 lbs	25.98" X 38.58" X 0.83"
UC2255N034	31.18" X 41.18"	30" X 40"	29.21" X 39.21"	6.944 lbs	31.89" X 42.13" X 0.91"

1.65" / 42 mm Profile, 45°: Silver anodized aluminum				WEIGHT	PACKING SIZE
ARTICLE	EXTERNAL (x-y)	POSTER	COPY	WITH PACKING	*W X H X D
UC2425N023	21.69" X 31.69"	20" X 30"	18.39" X 28.39"	4.739 lbs	22.44" X 32.28" X 1.22"
UC2425N034	31.69" X 41.69"	30" X 40"	28.39" X 38.39"	7.936 lbs	32.28" X 42.52" X 1.22"
UC2425N046	41.69" X 61.69"	40" X 60"	38.39" X 58.39"	13.227 lbs	41.73" X 61.81" X 1.22"



*W:Width H: Height D: Depth

Lockable Snap Frames



The four sides of the lockable frame open sequentially. The last profile is held in place with a screw on top that can be opened with its key. This system ensures your poster is never accessed by unauthorized third parties. Anti-glare poster cover sheet.

Each frame includes an allen key to open the locked profile. Each frame includes wall mounting accessories (4 screws & 4 plugs).

"Optional hangers" permit easy mounting.

Suitable for silk screen printing, max. letter height is 0.63".



UYAA011010
V hanger



Secured with allen key

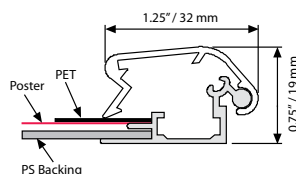
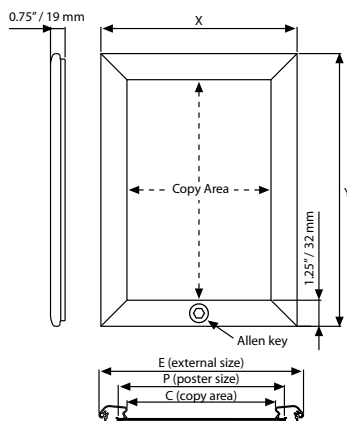

MATERIAL : Silver anodized aluminum					WEIGHT	PACKING SIZE
SILVER	BLACK	EXTERNAL (x-y)	POSTER	COPY	WITH PACKING	*W X H X D
UCL325N018	UCL325B018	19.72" X 25.71"	18" X 24"	17.24" X 23.23"	3.306 lbs	20.47" X 26.38" X 1.22"
UCL325N022	UCL325B022	23.70" X 29.69"	22" X 28"	21.22" X 27.20"	5.732 lbs	24.41" X 30.71" X 1.22"
UCL325N024	UCL325B024	25.71" X 37.68"	24" X 36"	23.23" X 35.20"	5.621 lbs	27.17" X 38.58" X 1.22"

*W:Width H: Height D: Depth





Double Color Frames



Double color frames are a snap open design with multiple color profiles. Anti-glare poster cover sheet.

 Each frame includes wall mounting accessories (4 screws & 4 plugs).

 "Optional hangers" permit easy mounting.

 Suitable for silk screen printing, max. letter height is 0.59".



2 colors in 1 frame



UYAA011010
V hanger

Outer profiles red, inner profiles silver

Outer profiles black, inner profiles silver

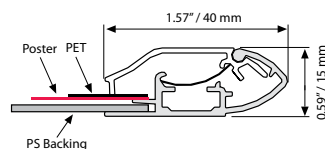
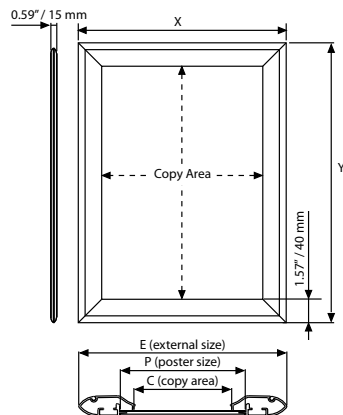

MATERIAL : Silver anodized aluminum					WEIGHT	PACKING SIZE
BLACK-SILVER	RED-SILVER	EXTERNAL (x-y)	POSTER	COPY	WITH PACKING	*W X H X D
UCC405BN22	UCC405RN22	24.33" X 30.31"	22" X 28"	21.26" X 27.24"	6.062 lbs	24.41" X 30.71" X 1.22"
UCC405BN24	UCC405RN24	26.34" X 38.31"	24" X 36"	23.27" X 35.24"	8.377 lbs	26.77" X 38.58" X 1.22"

*W:Width H: Height D: Depth





Paper Boards



Paperboards are a snap open design paper holder. Suitable for indoor use in portrait position. They are provided with 2 clear plastic clips for each insert. Anti-glare poster cover sheet.

 Each frame includes wall mounting accessories (4 screws & 4 plugs).

 "Optional hangers" permit easy mounting.

 Suitable for silk screen printing, max. letter height is 0.59".



Outer profiles black, inner profiles silver



Outer profiles silver, inner profiles black

2 colors in 1 frame



UYAA011010
V hanger

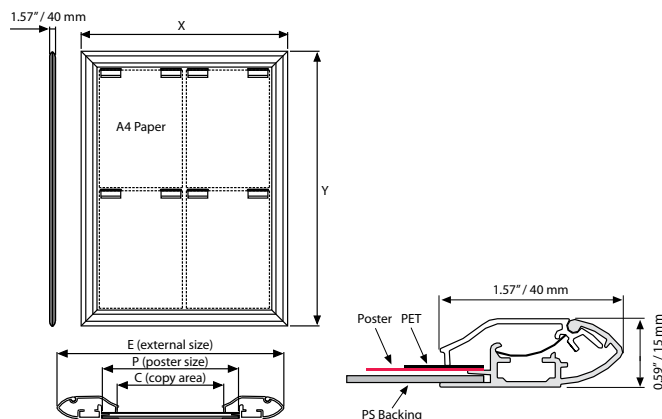

MATERIAL : Silver anodized aluminum					WEIGHT	PACKING SIZE
ARTICLE	EXTERNAL (x-y)	PAPER AREA	CAPACITY	DESCRIPTION	WITH PACKING	*W X H X D
UPB405BN04	21.02" X 25.91"	17.87" X 22.76"	4 X (8.5" X 11")	Black-Silver	4,629 lbs	21.26" X 28.35" X 1.22"
UPB405BN06	29.92" X 25.91"	26.77" X 22.76"	6 X (8.5" X 11")	Black-Silver	6,062 lbs	29.92" X 40.16" X 1.22"
UPB405BN09	29.92" X 37.20"	26.77" X 34.06"	9 X (8.5" X 11")	Black-Silver	8,157 lbs	28.35" X 29.92" X 1.22"
UPB405NB04	21.02" X 25.91"	17.87" X 22.76"	4 X (8.5" X 11")	Silver-Black	4,629 lbs	21.26" X 28.35" X 1.22"
UPB405NB06	29.92" X 25.91"	26.77" X 22.76"	6 X (8.5" X 11")	Silver-Black	6,062 lbs	29.92" X 40.16" X 1.22"
UPB405NB09	29.92" X 37.20"	26.77" X 34.06"	9 X (8.5" X 11")	Silver-Black	8,157 lbs	28.35" X 29.92" X 1.22"

* W:Width H: Height D: Depth



Magnetic Frame Single Sided



See movie at our website www.mtdisplays.com.tr



A poster frame with magnetic cover brings new style to frames. It is very slim and elegant and different than most frames available. Can be used landscape or portrait.

Complete with wall fixing components.

Hidden finger hole on the short profile for easy opening of magnetic cover. No assembly required.

Color options

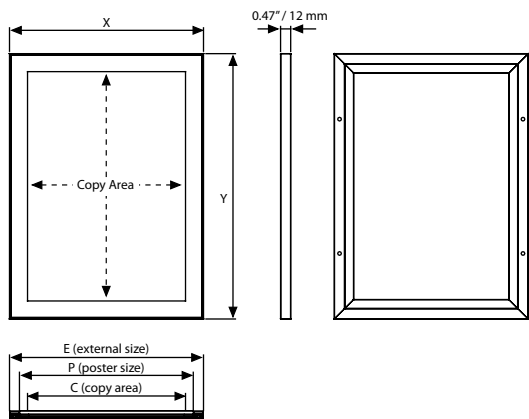
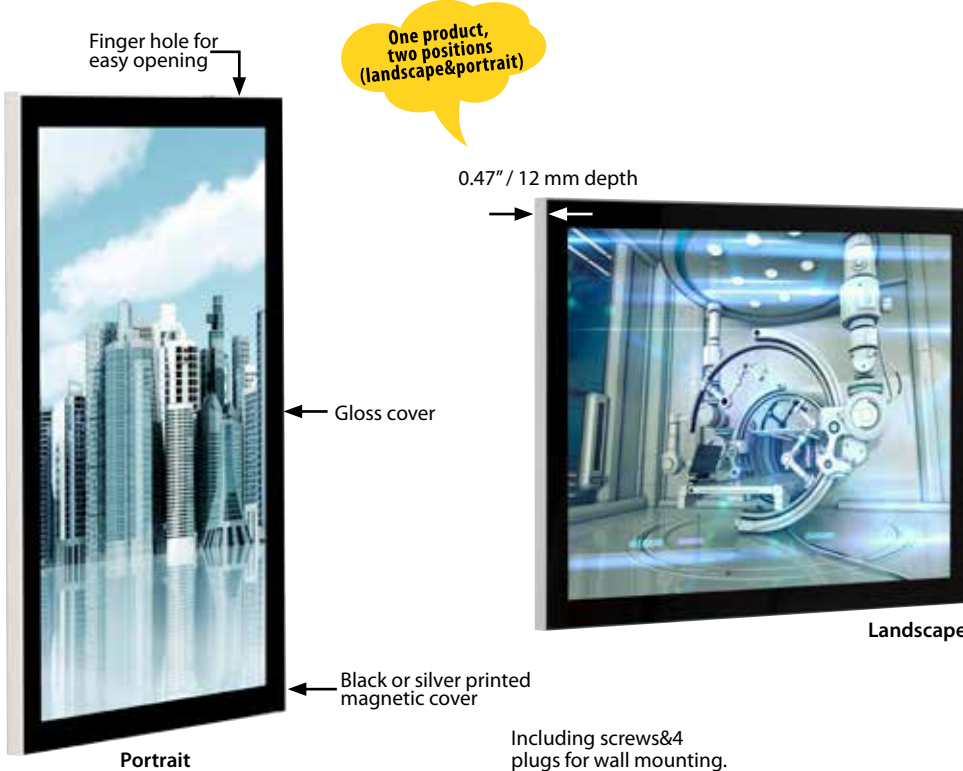

MATERIAL : Silver anodized aluminum						WEIGHT	PACKING SIZE
SILVER	BLACK	EXTERNAL (x-y)	POSTER	COPY	DESCRIPTION	WITH PACKING	*W X H X D
UCMONTB081	UCMOBTB081	9.56" X 12.06"	8.5" X 11"	7.83" X 10.33"	Landscape-Portrait	1.543 lbs	10.67" X 14.17" X 1.22"
UCMONTB017	UCMOBTB017	12.06" X 18.06"	11" X 17"	10.33" X 16.33"	Landscape-Portrait	2.645 lbs	13.19" X 19.37" X 1.22"
UCMONTB018	UCMOBTB018	19.06" X 25.06"	18" X 24"	17.33" X 23.33"	Landscape-Portrait	4.629 lbs	20.20" X 27.17" X 1.22"
UCMONTB022	UCMOBTB022	23.06" X 29.06"	22" X 28"	21.33" X 27.33"	Landscape-Portrait	6.393 lbs	24.17" X 31.18" X 1.22"
UCMONTB023	UCMOBTB023	21.06" X 31.06"	20" X 30"	19.33" X 29.33"	Landscape-Portrait	6.172 lbs	22.17" X 33.15" X 1.22"
UCMONTB024	UCMOBTB024	25.06" X 37.06"	24" X 36"	23.33" X 35.33"	Landscape-Portrait	9.259 lbs	26.18" X 39.17" X 1.22"
UCMONTB034	UCMOBTB034	31.06" X 41.06"	30" X 40"	29.33" X 39.33"	Landscape-Portrait	15.211 lbs	38.19" X 43.15" X 1.22"

*W:Width H: Height D: Depth



Magnetic Frame Double Sided



See movie at our website www.mtdisplays.com.tr



A poster frame with magnetic cover brings new style to frames. It is elegant and different than most frames available. Double Sided Magnetic Frame can be easily used landscape or portrait by adjusting suspension cable manually.

Complete with wall fixing components.

Hidden finger hole on the short profile for easy opening of magnetic cover. No assembly required.

Color options



One product,
two positions
(landscape&portrait)

78.74" / 2 meter

Including suspension kit.

0.75" / 19 mm depth

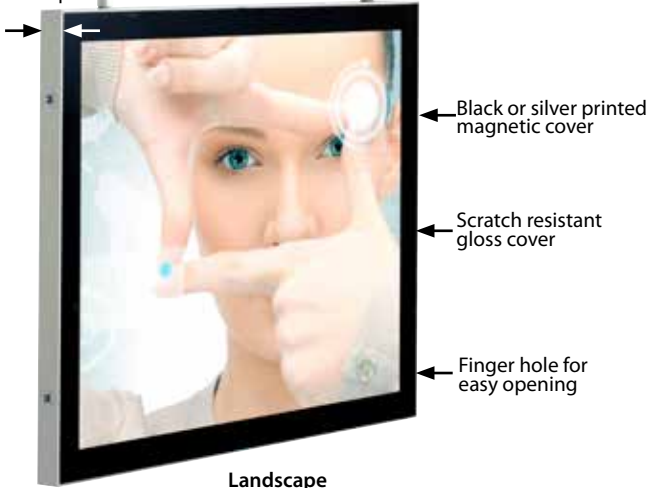

Landscape



Portrait

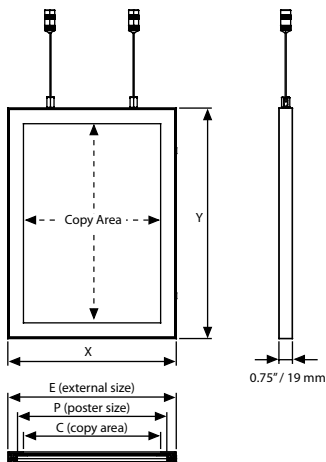

MATERIAL : Silver anodized aluminum						WEIGHT	PACKING SIZE
SILVER	BLACK	EXTERNAL (x-y)	POSTER	COPY	DESCRIPTION	WITH PACKING	*W X H X D
UCMONCB081	UCMOBCB081	9.56" X 12.06"	8.5" X 11"	7.83" X 10.33"	Landscape-Portrait	1.984 lbs	10.08" X 13.58" X 0.83"
UCMONCB017	UCMOBCB017	12.06" X 18.06"	11" X 17"	10.33" X 16.33"	Landscape-Portrait	3.306 lbs	12.60" X 19.57" X 0.83"
UCMONCB018	UCMOBCB018	19.06" X 25.06"	18" X 24"	17.33" X 23.33"	Landscape-Portrait	6.172 lbs	19.61" X 26.57" X 0.83"
UCMONCB022	UCMOBCB022	23.06" X 29.06"	22" X 28"	21.33" X 27.33"	Landscape-Portrait	8.598 lbs	23.58" X 30.59" X 0.83"
UCMONCB023	UCMOBCB023	21.06" X 31.06"	20" X 30"	19.33" X 29.33"	Landscape-Portrait	8.377 lbs	21.57" X 32.56" X 0.83"
UCMONCB024	UCMOBCB024	25.06" X 37.06"	24" X 36"	23.33" X 35.33"	Landscape-Portrait	12.125 lbs	25.59" X 38.58" X 0.83"
UCMONCB034	UCMOBCB034	31.06" X 41.06"	30" X 40"	29.33" X 39.33"	Landscape-Portrait	20.502 lbs	37.60" X 42.56" X 0.83"

*W:Width H: Height D: Depth





Slide-in Frames

- Counter Slide-in Frame
- Single Sided Slide-in Frame
- Double Sided Slide-in Frame



Counter Slide-in Frames



See movie at our website www.mtdisplays.com.tr



A new model of counter stand slide-in frame. Practical to change posters by sliding them in & out. Comes with 2 PET covers, an end plastic wick on the open side & double-sided tape at the bottom feet. This product is delivered in the landscape position for standard articles. An optional portrait position is available.

! Please clean the surface before applying the double sided tape for better application. Suitable for silk screen printing, maximum letter height is 0.35".



8.5" X 11" size portrait



8.5" X 11" size landscape

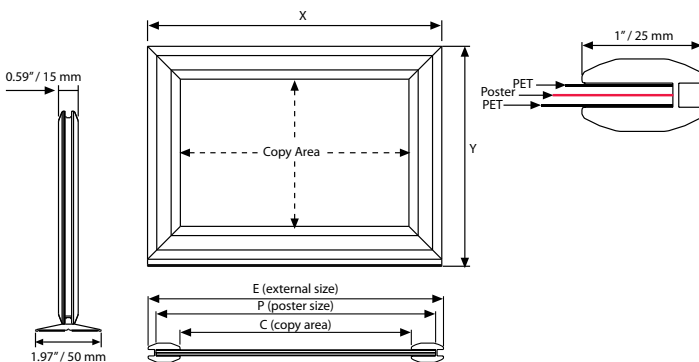
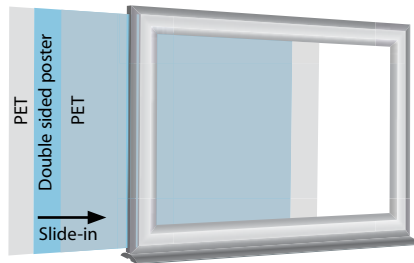

MATERIAL : Silver anodized aluminum					WEIGHT	PACKING SIZE
PORTRAIT	EXTERNAL(x-y)	POSTER	COPY	DESCRIPTION	WITH PACKING	*W X H X D
UCA255B181	9.06" X 11.77"	8.5" X 11"	7.09" X 9.61"	Black	1.720 lbs	10.63" X 13.78" X 2.76"
UCA255N181	9.06" X 11.77"	8.5" X 11"	7.09" X 9.61"	Silver	1.720 lbs	10.63" X 13.78" X 2.76"
UCA255B117	11.57" X 17.76"	11" X 17"	9.61" X 15.59"	Black	2.654 lbs	12.20" X 18.11" X 2.36"
UCA255N117	11.57" X 17.76"	11" X 17"	9.61" X 15.59"	Silver	2.654 lbs	12.20" X 18.11" X 2.36"

MATERIAL : Silver anodized aluminum					WEIGHT	PACKING SIZE
LANDSCAPE	EXTERNAL(x-y)	POSTER	COPY	DESCRIPTION	WITH PACKING	*W X H X D
UCA255B281	11.57" X 9.25"	8.5" X 11"	9.61" X 7.09"	Black	1.720 lbs	10.63" X 13.78" X 2.76"
UCA255N281	11.57" X 9.25"	8.5" X 11"	9.61" X 7.09"	Silver	1.720 lbs	10.63" X 13.78" X 2.76"
UCA255B217	17.56" X 11.77"	11" X 17"	15.59" X 9.61"	Black	2.654 lbs	12.20" X 18.11" X 2.36"
UCA255N217	17.56" X 11.77"	11" X 17"	15.59" X 9.61"	Silver	2.654 lbs	12.20" X 18.11" X 2.36"



* W:Width H: Height D: Depth

Single Sided Slide-in Frames



The same unit can be used both in landscape & portrait positions. A practical frame enabling you to easily change your posters by sliding the graphics in & out.

Each frame includes wall mounting accessories (4 screws & 4 plugs) Color options black & silver anodized.

! Suitable for silk screen printing, max. letter height is 0.51".

Color options

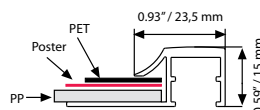
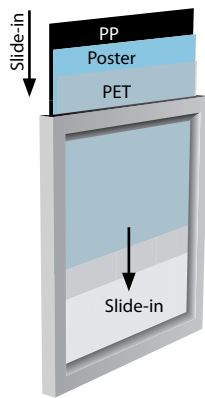
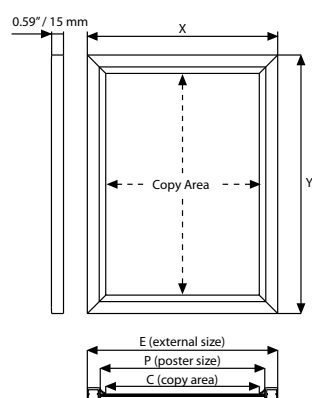
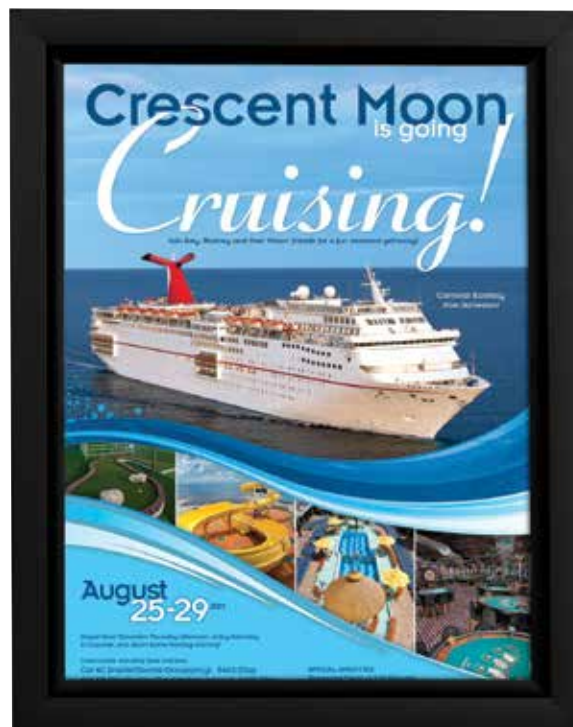

MATERIAL : Silver anodized aluminum					WEIGHT	PACKING SIZE
SILVER	BLACK	EXTERNAL(x-y)	POSTER	COPY	WITH PACKING	*W X H X D
UCS245N181	UCS245B181	9.80" X 12.32"	8.5" X 11"	7.95" X 10.47"	1.102 lbs	10.63" X 12.99" X 0.83"
UCS245N117	UCS245B117	12.32" X 18.31"	11" X 17"	10.47" X 16.46"	1.873 lbs	12.99" X 18.90" X 0.83"
UCS245N118	UCS245B118	19.33" X 25.31"	18" X 24"	17.48" X 23.46"	2.645 lbs	20.08" X 25.98" X 0.83"
UCS245N122	UCS245B122	23.30" X 29.30"	22" X 28"	21.46" X 27.48"	3.637 lbs	24.02" X 30.31" X 0.83"
UCS245N124	UCS245B124	25.30" X 37.30"	24" X 36"	23.45" X 35.45"	4.850 lbs	25.59" X 37.80" X 0.83"



*W:Width H: Height D: Depth

Double Sided Slide-in Frames



A practical frame enabling you to easily change your posters by sliding the graphics in & out. The double PET cover in the frame protects your poster from any sun and light effects.

Each frame includes 2 suspension hangers.

Moving hangers provide easy positioning for hanging.

Suitable for silk screen printing, max. letter height is 0.35".



8.5" X 11" size landscape

8.5" X 11" size portrait

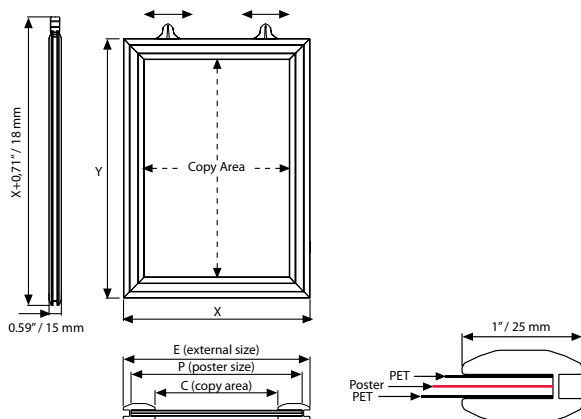

MATERIAL : Silver anodized aluminum						WEIGHT	PACKING SIZE
PORTRAIT	LANDSCAPE	EXTERNAL(x-y)	POSTER	COPY	DESCRIPTION	WITH PACKING	*W X H X D
UCS255N181	UCS255N281	9.06" X 11.57"	8.5" X 11"	7.09" X 9.61"	Silver	1.102 lbs	10.63" X 12.99" X 0.83"
UCS255N117	UCS255N217	11.57" X 17.56"	11" X 17"	9.61" X 15.59"	Silver	1.873 lbs	12.99" X 18.90" X 0.83"
UCS255N118	UCS255N218	18.58" X 24.57"	18" X 24"	16.61" X 22.60"	Silver	2.645 lbs	20.08" X 25.98" X 0.83"
UCS255N122	UCS255N222	22.56" X 28.58"	22" X 28"	20.59" X 26.61"	Silver	3.637 lbs	24.02" X 30.31" X 0.83"
UCS255B181	UCS255B281	9.06" X 11.57"	8.5" X 11"	7.09" X 9.61"	Black	1.102 lbs	10.63" X 12.99" X 0.83"
UCS255B117	UCS255B217	11.57" X 17.56"	11" X 17"	9.61" X 15.59"	Black	1.873 lbs	12.99" X 18.90" X 0.83"
UCS255B118	UCS255B218	18.58" X 24.57"	18" X 24"	16.61" X 22.60"	Black	2.645 lbs	20.08" X 25.98" X 0.83"
UCS255B122	UCS255B222	22.56" X 28.58"	22" X 28"	20.59" X 26.61"	Black	3.637 lbs	24.02" X 30.31" X 0.83"

*W:Width H: Height D: Depth





Weatherproof Frames

- Lockable Weatherproof Frame
- Weatherproof Frame 1" / 25mm
- Weatherproof Frame 1.38" / 35mm



Lockable Weatherproof Frames



The four sides of the lockable frame open sequentially. The last profile is held in place with a screw on top that can be opened with its key. This system ensures your poster is never accessed by unauthorized third parties. Suitable for outdoor use. The product has water drainage slots (for details see assembly sheet). Anti-glare / anti UV poster cover sheet.

Each frame includes an allen key to open the locked profile. Each frame includes wall mounting accessories (4 screws & 4 plugs).

"Optional hangers" permit easy mounting.

Suitable for silk screen printing. max. letter height is 0.63". Please use the pull sticker to take off the cover. Please place the poster inside the water wick around the inner frame.



Patent Pending
TR 2006 06254
PCT/TR06/000064



UYAA011010
V hanger

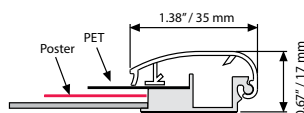
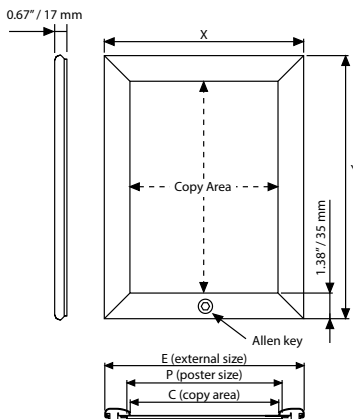

MATERIAL : Silver anodized aluminum					WEIGHT	PACKING SIZE
SILVER	BLACK	EXTERNAL (x-y)	POSTER	COPY	WITH PACKING	*W X H X D
UCV355N023	UCV355B023	22.60" X 32.60"	20" X 30"	19.84" X 29.84"	4.629 lbs	22.83" X 32.83" X 0.91"
UCV355N034	UCV355B034	32.60" X 42.60"	30" X 40"	29.84" X 39.84"	9.700 lbs	32.83" X 42.83" X 0.91"
UCV355N046	UCV355B046	42.60" X 62.60"	40" X 60"	39.84" X 59.84"	18.077 lbs	42.83" X 62.99" X 0.91"
UCV355N022	UCV355B022	24.60" X 30.60"	22" X 28"	21.84" X 27.84"	5.643 lbs	24.41" X 30.71" X 1.22"
UCV355N024	UCV355B024	26.60" X 38.60"	24" X 36"	23.84" X 35.84"	7.605 lbs	26.77" X 38.58" X 1.22"



*W:Width H: Height D: Depth

Weatherproof Frames

1" / 25 mm



- Suitable for outdoor use.
- Ideal for posters of every size.
- Natural silver anodized and black color available.
- Mitered corners.
- There are water drainage slots on the product (for details see assembly sheet).
- Anti-glare / anti UV poster cover sheet.

 Each frame includes wall mounting accessories (4 screws & 4 plugs).

 "Optional hangers" permit easy mounting.

 Please use the pull sticker to take off the cover. Please place the poster inside the water wick around the poster area of the frame.



Patent Pending
TR 2006 06254
PCT/TR 2006/000064

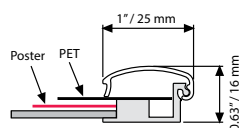
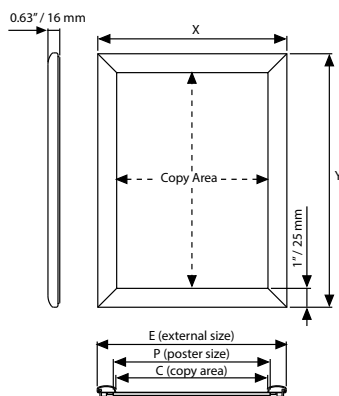

MATERIAL : Silver anodized aluminum					WEIGHT	PACKING SIZE
SILVER	BLACK	EXTERNAL (x-y)	POSTER	COPY	WITH PACKING	*W X H X D
UCH255N018	UCH255B018	19.88" X 25.94"	18" X 24"	17.87" X 23.94"	3.527 lbs	20.47" X 26.38" X 0.91"
UCH255N022	UCH255B022	23.94" X 29.92"	22" X 28"	21.93" X 27.91"	4.850 lbs	24.41" X 30.71" X 1.22"
UCH255N024	UCH255B024	25.94" X 37.91"	24" X 36"	23.94" X 35.91"	5.401 lbs	26.77" X 38.58" X 1.22"

*W:Width H: Height D: Depth





Weatherproof Frames

1.38" / 35 mm



- Suitable for use in outdoor conditions.
- Ideal for posters of every size.
- Natural silver anodized and black color available.
- Mitered corners.
- There are water drainage slots on the product (for details see assembly sheet).
- Anti-glare / anti UV poster cover sheet.

 Each frame includes wall mounting accessories (4 screws & 4 plugs).

 "Optional hangers" permit easy mounting.

 Please use the pull sticker to take off the cover. Please place the poster inside the water wick around the poster area of the frame.

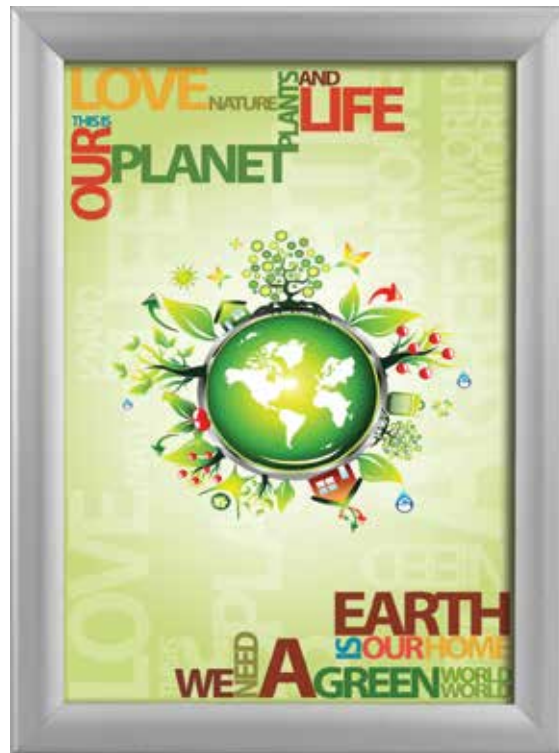

Patent Pending
TR 2006 06254
PCT/TR 2006/000064

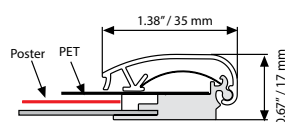
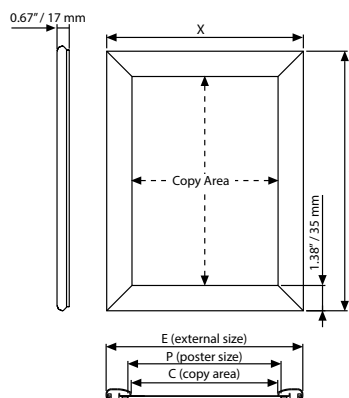

MATERIAL : Silver anodized aluminum					WEIGHT	PACKING SIZE
SILVER	BLACK	EXTERNAL (x-y)	POSTER	COPY	WITH PACKING	*W X H X D
UCH355N018	UCH355B018	20.47" X 26.46"	18" X 24"	17.72" X 23.70"	4.078 lbs	21.65" X 27.17" X 1.22"
UCH355N022	UCH355B022	24.45" X 30.47"	22" X 28"	21.69" X 27.72"	5.511 lbs	25.59" X 31.50" X 1.22"
UCH355N024	UCH355B024	26.46" X 38.46"	24" X 36"	23.70" X 35.71"	7.495 lbs	27.56" X 39.37" X 1.22"

* W:Width H: Height D: Depth





Poster Hangers

- Poster Snaps
- Banner Hangers
- Poster Fast
- Stretch Frames
- Poster Clamps
- Outdoor Flap Grippers



Poster Snaps 1.02" / 26mm



See movie at our website www.mtdisplays.com.tr



One set includes the upper and the bottom profiles with the end caps on both profiles and the hangers on the top profile. Improved rubber foam for poster suspension.

Single packed as a set in plastic bags.

No tool assembly.

Moving hangers permit easy assembly. Suitable for silk screen printing, max. letter height is 0.39".

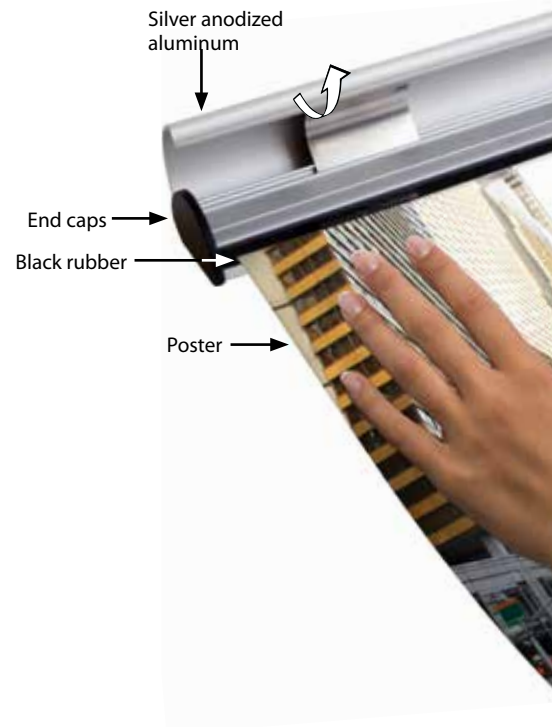

Patent Pending
TR 2005 01301

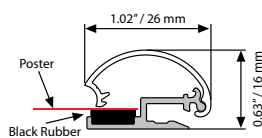
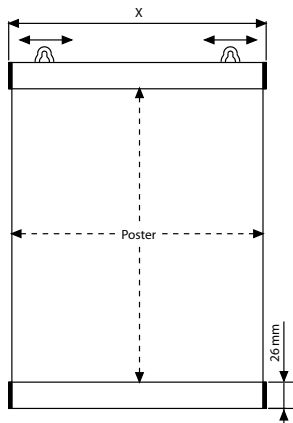

MATERIAL : Silver anodized aluminum			WEIGHT	PACKING SIZE
ARTICLE	EXTERNAL (x)	POSTER	WITH PACKING	*W X H X D
UPT26SN458	18.19"	18"	0.727 lbs	2.36" X 20.47" X 1.77"
UPT26SN559	22.17"	22"	0.903 lbs	2.36" X 24.80" X 1.77"
UPT26SN610	24.17"	24"	0.727 lbs	2.36" X 26.77" X 1.77"
UPT26SN686	27.17"	27"	1.102 lbs	2.36" X 29.92" X 1.77"
UPT26SN762	30.16"	30"	1.212 lbs	2.36" X 32.68" X 1.77"
UPT26SN915	36.18"	36"	1.256 lbs	2.36" X 38.98" X 1.77"
UPT26SN122	48.19"	48"	1.807 lbs	2.36" X 50" X 1.77"
UPT26SN182	72.17"	72"	2.755 lbs	2.36" X 74.80" X 1.77"



*W:Width H: Height D: Depth

Banner Hangers

1" / 25 mm



A newly created series of poster clamps offers competitive solutions. Suitable for posters in thickness 50 of microns / 500 microns. One set includes end caps on both profiles and hangers on the top profile.

Single packed as set in plastic bags. Turning end caps help to slide the poster in.

No tool assembly. Hangers are suitable for wall mounting and ceiling suspension. Moving hangers allow easy assembly.

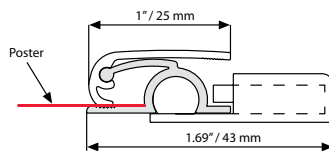
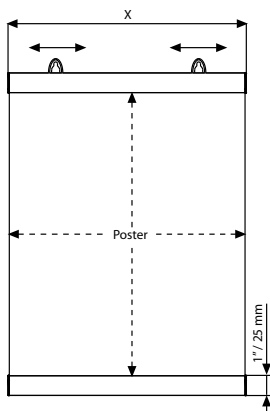
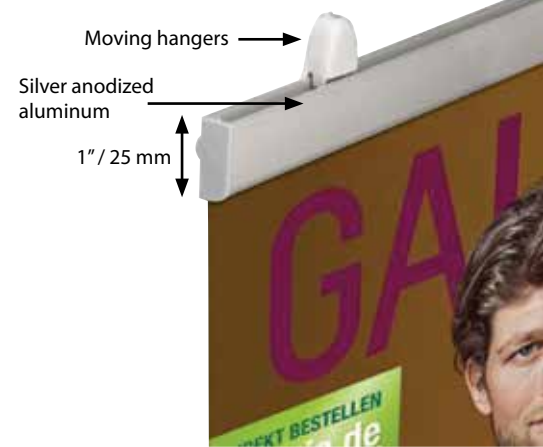

MATERIAL : Silver anodized aluminum			WEIGHT	PACKING SIZE
ARTICLE	EXTERNAL (x)	POSTER	WITH PACKING	*W X H X D
UPC10SN610	24.17"	24"	1.124 lbs	2.36" X 26.77" X 1.77"
UPC10SN762	30.16"	30"	1.344 lbs	2.36" X 32.68" X 1.77"
UPC10SN915	36.18"	36"	1.543 lbs	2.36" X 38.98" X 1.77"
UPC10SN122	48.19"	48"	2.182 lbs	2.36" X 50" X 1.77"
UPC10SN183	72.17"	72"	3.306 lbs	2.36" X 74.80" X 1.77"



*W:Width H: Height D: Depth



Poster Fast



See movie at our website www.mtdisplays.com.tr



Suitable for heavier and bigger posters in thickness 10 of microns / 500 microns. A double-sided poster holder. One set includes end caps on both profiles and hangers on the top profile. The product is supplied with 1.57" clear co-extrusion components inside which hold the poster.

-  Single packed as a set in plastic bags.
-  No tool assembly. Turning end caps help to slide the poster in. Moving hangers permit easy assembly. Hangers are suitable for wall mounting & ceiling suspension.
-  Suitable for silk screen printing, max. letter height is 0.39"



Double sided

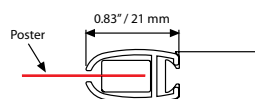
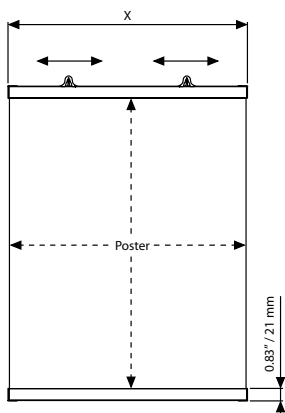

MATERIAL : Silver anodized aluminum			WEIGHT	PACKING SIZE
ARTICLE	EXTERNAL (x)	POSTER	WITH PACKING	*W X H X D
UPF21SN061	24.21"	24"	0.749 lbs	2.36" X 26.77" X 1.77"
UPF21SN762	30.20"	30"	0.947 lbs	2.36" X 32.68" X 1.77"
UPF21SN915	36.22"	36"	1.146 lbs	2.36" X 38.98" X 1.77"
UPF21SN122	48.23"	48"	1.521 lbs	2.36" X 50" X 1.77"
UPF21SN182	72.20"	72"	2.259 lbs	2.36" X 74.80" X 1.77"

*W:Width H: Height D: Depth



Stretch Frames



See movie at our website www.mtdisplays.com.tr



A lightweight frame that stretches the poster from 4 corners. The poster can be easily changed with the help of plastic clips. It is available in standard anodized silver. Other colors are available upon request. Two plastic hangers for both wall mounting and ceiling suspension are included. The plastic clips stretched from the corners place the poster in the center.

Single packed unassembled in carton boxes with an easy-to-understand instruction sheet. Each pack includes 4 clips & 2 hanger.

Hangers are suitable for wall mounting & ceiling suspension.

Recommended poster material is paper, any heavier material such as vinyl or textile may damage the springs at the corner.
Suitable for silk screen printing, max. letter height is 0.31"

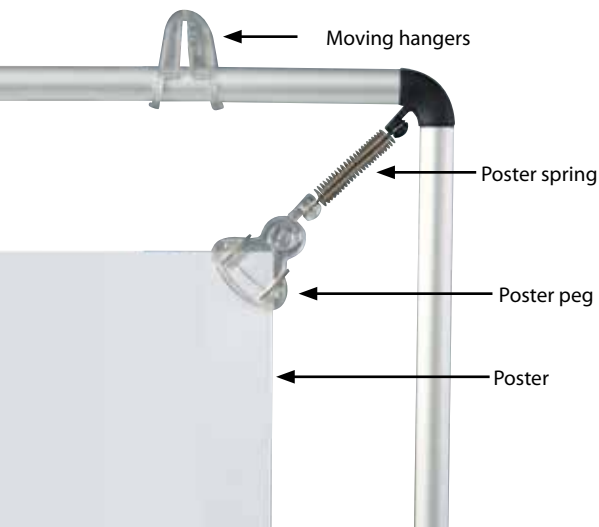

Stretch Frame packing

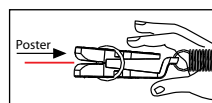
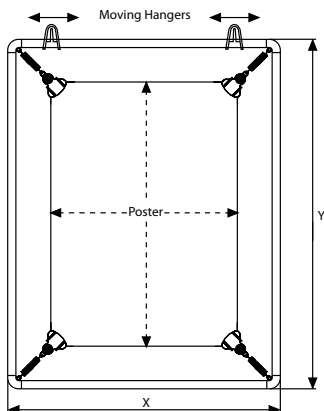

MATERIAL : Silver anodized aluminum			WEIGHT	PACKING SIZE
ARTICLE	EXTERNAL (x-y)	POSTER	WITH PACKING	*W X H X D
UPSCN00081	12.44" X 14.96"	8.5" X 11"	0.242 lbs	2.17" X 1.69" X 1.18"
UPSCN00017	14.96" X 20.94"	11" X 17"	0.473 lbs	2.17" X 2.13" X 1.18"
UPSCN00018	21.97" X 27.95"	18" X 24"	0.595 lbs	2.17" X 2.83" X 1.18"
UPSCN00022	25.94" X 31.97"	22" X 28"	0.639 lbs	2.17" X 3.27" X 1.18"

*W:Width H: Height D: Depth



Poster Clamps

1.30" / 30 mm



See movie at our website www.mtdisplays.com.tr

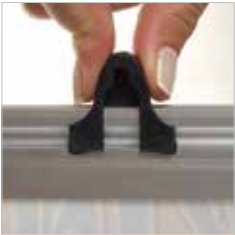

Suitable for heavier and bigger posters in thickness of 50 microns / 500 microns. One set includes the end caps on both profiles and the hangers on the top profile.

Single packed as set in plastic bags. Turning end caps help to slide the poster in.

No tool assembly. Hangers are suitable for wall mounting & ceiling suspension.

Moving hangers permit easy assembly. Suitable for silk screen printing, max. letter height is 0.71".

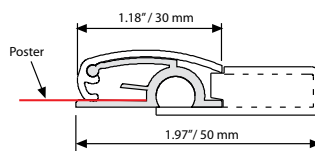
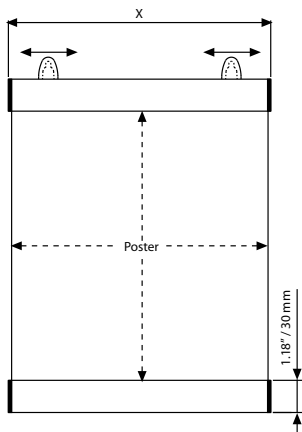

MATERIAL : Silver anodized aluminum			WEIGHT	PACKING SIZE
ARTICLE	EXTERNAL (x)	POSTER	WITH PACKING	*W X H X D
UPC00SN610	24.25"	24"	0.903 lbs	2.36" X 25.98" X 1.77"
UPC00SN762	30.24"	30"	1.124 lbs	2.36" X 32.28" X 1.77"
UPC00SN915	36.26"	36"	1.366 lbs	2.36" X 37.80" X 1.77"
UPC00SN122	48.27"	48"	1.807 lbs	2.36" X 74.41" X 1.77"
UPC00SN183	72.24"	72"	2.711 lbs	2.36" X 50.39" X 1.77"

*W:Width H: Height D: Depth



Outdoor Flap Grippers



See movie at our website www.mtdisplays.com.tr



Outdoor Flap Grippers offer innovative solutions for your advertising needs. It is designed to mount rigid double-sided panels onto outer walls. It gets the attention of 2-way traffic. It accepts rigid panels in 5mm thickness. EN certified wall fixing increase the security of the product in use. Fixing is covered by plastic end caps to provide a clean finish to the product.

Wall mounting and panel mounting accessories included.

PVC foam Panels are optional .

Max height 59.06" & max. width 23.62".

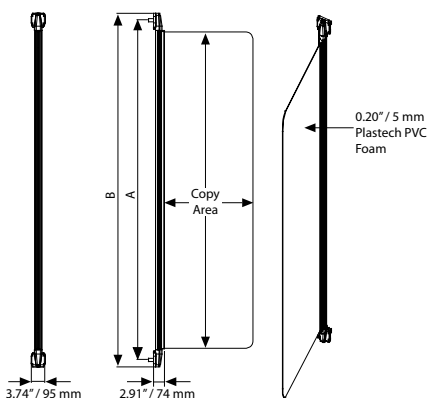

Wall mounting screws of Outdoor Flap Grippers are included in the pack which are CE certified multi-expansion long plugs. Special anti-corrosion coated screws are made of zinc coated steel and plastic sleeves made of high quality nylon. It is confirmed for outdoor mounting on various exterior building surfaces such as concrete, solid or honeycomb brick, hollow dense or hollow light aggregate block, aerated concrete and solid stone.

PANEL: 0.20" Plastech PVC Foam		MATERIAL : Silver anodized aluminum - excluding panel				WEIGHT	PACKING SIZE
ARTICLE	POSTER SIZE	ARTICLE	POSTER SIZE	COPY AREA	A	B	WITH PACKING *W X H X D
UYOFG10610	24.41" X 39.37"	UOFG00N100	24.41" X 39.37"	23.62" X 39.37"	42.32"	44.09"	10.141 lbs 4.33" X 46.06" X 3.74"
UYOFG10612	24.41" X 47.24"	UOFG00N120	24.41" X 47.24"	23.62" X 47.24"	50.20"	51.97"	12.125 lbs 4.33" X 53.94" X 3.74"
UYOFG10615	24.41" X 59.06"	UOFG00N150	24.41" X 59.06"	23.62" X 59.06"	62.01"	63.28"	14.770 lbs 4.33" X 65.75" X 3.74"



*W:Width H: Height D: Depth

Outdoor Flap Grippers





Showboards

- Poster Showboards
- Universal Poster Showboards

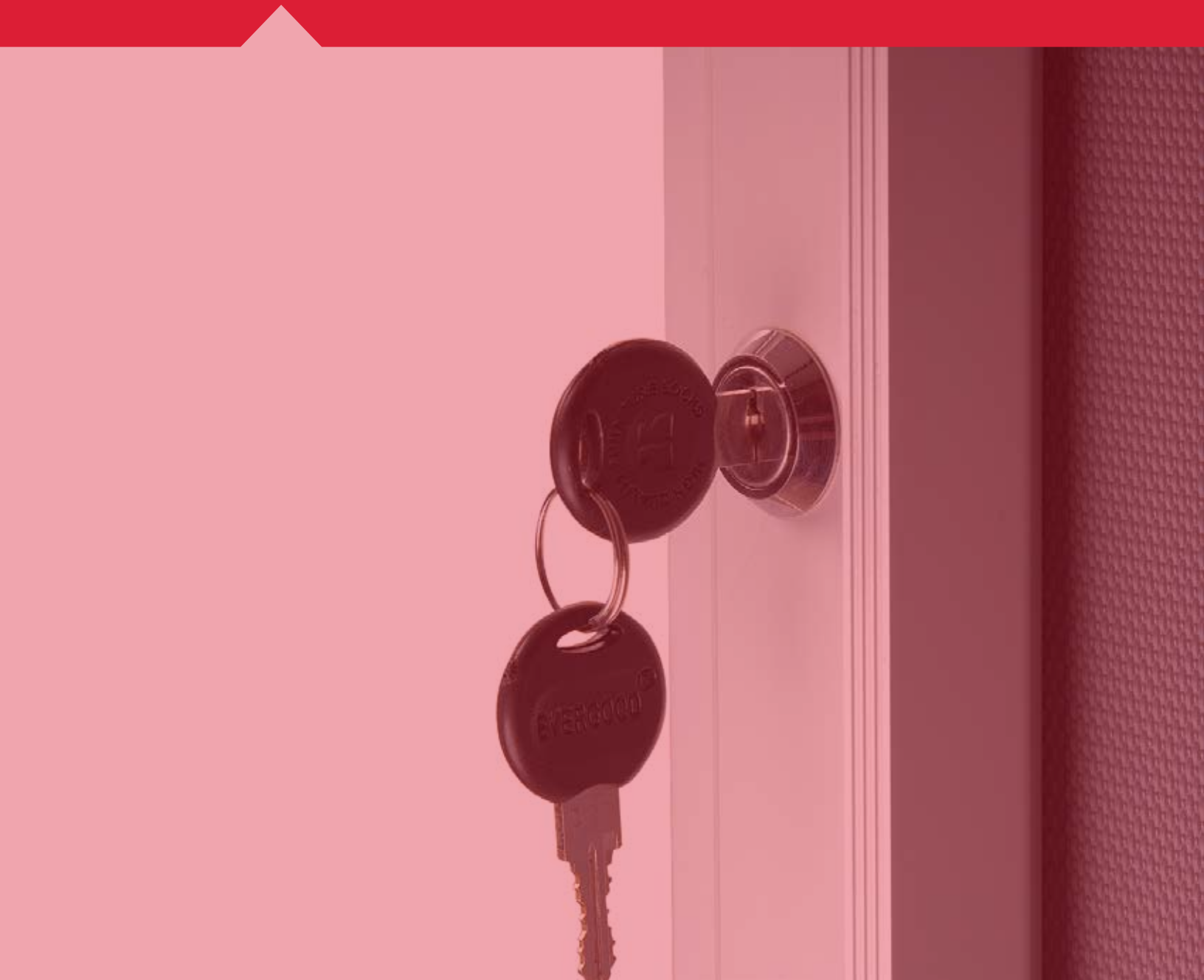

Poster Showboards



See movie at our website www.mtdisplays.com.tr



Ideal for displaying individual posters and single sheet menus. Suitable for outdoor use. The cover can be opened up to 90 degrees. Each unit includes mounting screws and plugs. The profile width is 1.77" and the depth of the case is 1.18".

Each product includes 1 key set.

Each unit is supplied with a free set of clear plastic pegs to hold the poster. 2 stop arms at each end help to keep the cover door open.

Please discard the protective film on the unit before use.

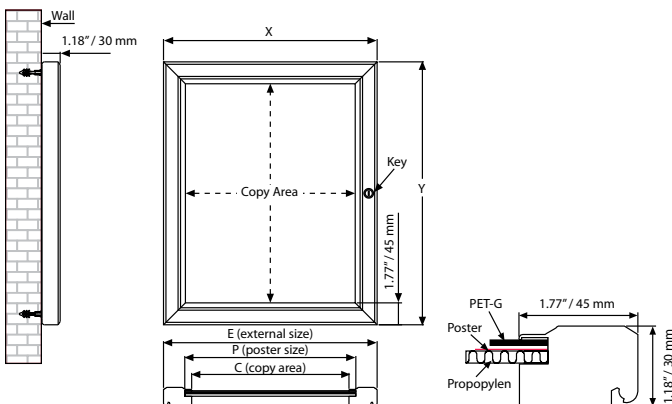
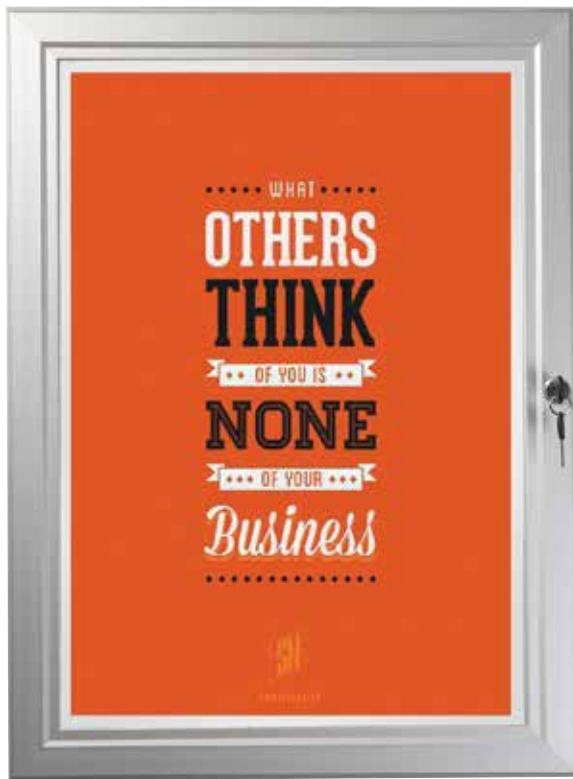

MATERIAL : Silver anodized aluminum					WEIGHT	PACKING SIZE
ARTICLE	EXTERNAL (x-y)	POSTER	COPY	KEY	WITH PACKING	*W X H X D
USBN000022	24.76" X 30.76"	22" X 28"	21.21" X 27.21"	1	10.471 lbs	25.79" X 31.69" X 2.17"
USBN000024	26.76" X 38.76"	24" X 36"	23.21" X 35.21"	1	12.345 lbs	27.95" X 39.76" X 2.17"
USBN000036	38.76" X 50.76"	36" X 48"	35.21" X 47.21"	2	21.605 lbs	39.96" X 51.77" X 2.17"

*W:Width H: Height D: Depth





Universal Poster Showboards



Slim and Sleek!

The lockable poster display case, Universal Showboard is designed to display printed posters in different options. When seen on the wall, it looks like a snap frame with slim case which is 1.06" deep, has a 1.18" profile and hidden lock on the side. It is suitable for public places or outdoor use under a shelter. It is easy to change the poster with hinged door and clips holding the poster.

 Each product includes 1 key set.

 Each unit is supplied with a free set of clear plastic pegs to hold the poster. 2 stop arms at each end help to keep the cover door open.

 Please discard the protective film on the unit before use.

1.06" / 27 mm thickness



Clear plastic pegs hold the poster



Discreet door lock

Stop Arms keep the door open

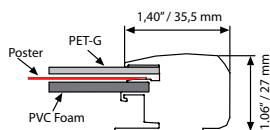
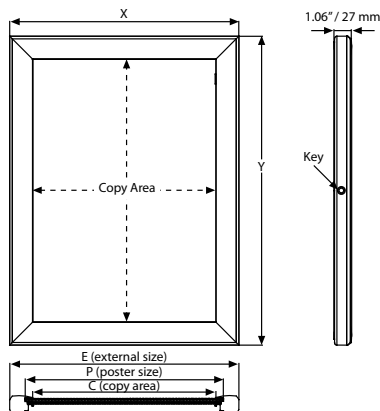

MATERIAL : Silver anodized aluminum					WEIGHT	PACKING SIZE
ARTICLE	EXTERNAL (x-y)	POSTER	COPY	KEY	WITH PACKING	*W X H X D
USBNU00018	20.24" X 26.27"	18" X 24"	17.45" X 23.45"	2	9.920 lbs	20.87" X 26.97" X 1.57"
USBNU00022	24.24" X 30.24"	22" X 28"	21.45" X 27.45"	2	12.125 lbs	24.80" X 30.91" X 1.57"
USBNU00024	26.27" X 38.24"	24" X 36"	23.45" X 35.45"	2	14.330 lbs	26.97" X 38.98" X 1.57"
USBNU00036	38.24" X 50.24"	36" X 48"	35.45" X 47.45"	2	22.046 lbs	38.98" X 50.59" X 1.57"

*W:Width H: Height D: Depth



Universal Poster Showboards





Banner Stands

- Cross Banners **NEW**
- Quick Banners
- Newage Quick Banners
- Retractable Roll Up Stands
- Smart Roll Banners
- Easy Swaps
- Poster Traps
- Optima Banners
- Eco Roll Banners
- Super Eco Roll Banners

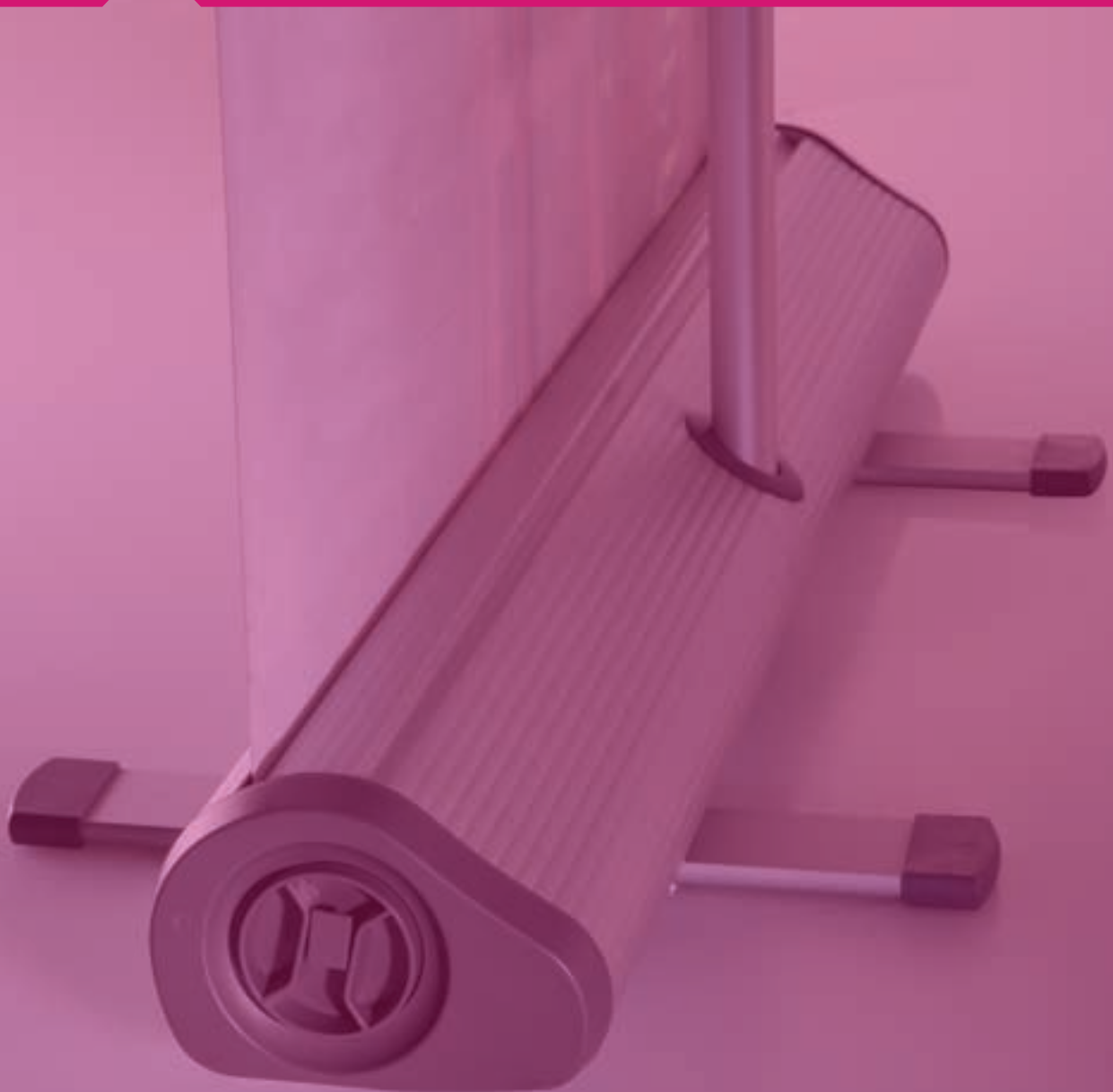

Cross Banners

new



See movie at our website www.mtdisplays.com.tr

Cross Single banner is a new style of banner systems. It rotates 360 degrees. The height of the poster is flexible, can be adjusted up to 2 meters. Powder coated steel feet provides stability to the product. It gets attention of customers rotating around easily.

Product comes unassembled, packed with an easy to understand instruction sheet.

Recommended up to 39.37" in poster size. Stainless aluminum legs are suitable for public spaces.

Black carry bag should be ordered separately.

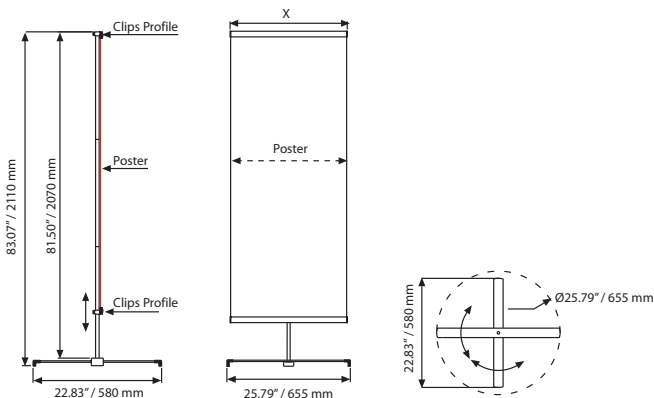
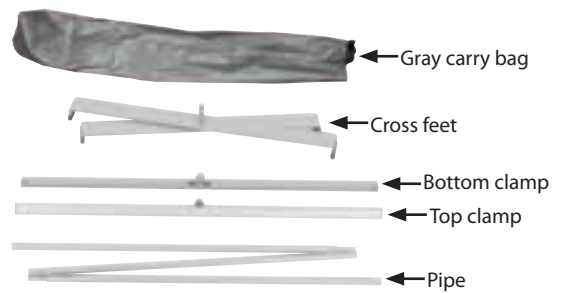
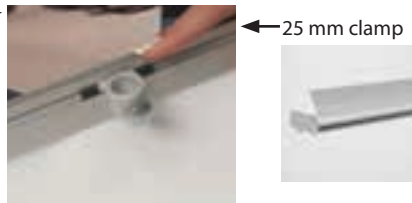

MATERIAL : Silver anodized aluminum			WEIGHT	PACKING SIZE (10 Pcs)
ARTICLE	POSTER	X	WITH PACKING	*W X H X D
USBC000N62	23.62" X max. 78.74"	23.86"	5.930 lbs	2.95" X 33.86" X 4.13"
USBC000N72	27.56" X max. 78.74"	27.80"	6.062 lbs	2.95" X 33.86" X 4.13"
USBC000N82	31.50" X max. 78.74"	31.73"	6.261 lbs	2.95" X 33.86" X 4.13"

*W:Width H: Height D: Depth



Quick Banners



See movie at our website www.mtdisplays.com.tr



Quick banner displays are a flexible and mobile poster clamp designed as a practical set that can be carried to conventions or exhibitions within its bag.

Packed with an easy to understand instruction sheet.



Single Sided



Patent Pending
TR 2005 01772



Double Sided

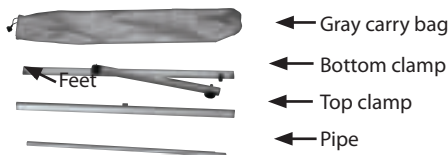

Single Sided

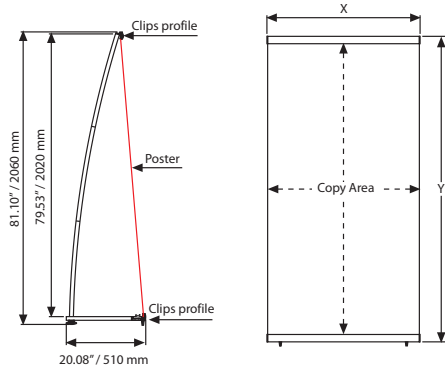

Double Sided

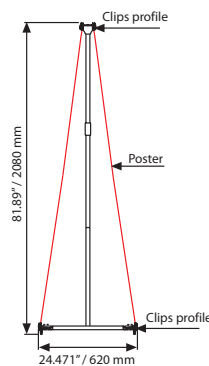

BAG		PACKING SIZE	
ARTICLE	MODEL	*W X H X D	
UYUP066000	31.50"	6.30" X 33.86" X 6.30"	
UYUP067000	39.37"	6.30" X 41.73" X 6.30"	

MATERIAL : Silver anodized aluminum				WEIGHT	PACKING SIZE
ARTICLE	EXTERNAL (x-y)	POSTER	COPY	WITH PACKING	*W X H X D
UQB0C00N72	27.80" X 79.92"	27.56" X 78.74"	27.56" X 77.56"	5.489 lbs	2.95" X 33.86" X 4.13"
UQB0C00N82	31.73" X 79.92"	31.50" X 78.74"	31.50" X 77.56"	5.842 lbs	2.95" X 33.86" X 4.13"
UQB0C00N92	35.67" X 79.92"	35.43" X 78.74"	35.43" X 77.56"	6.382 lbs	2.95" X 41.73" X 4.13"
UQB0C00N12	39.61" X 79.92"	39.37" X 78.74"	39.37" X 77.56"	6.746 lbs	2.95" X 41.73" X 4.13"

*W:Width H: Height D: Depth



MATERIAL : Silver anodized aluminum				WEIGHT	PACKING SIZE
ARTICLE	EXTERNAL (x-y)	POSTER	COPY	WITH PACKING	*W X H X D
UQB0T00N72	27.80" X 79.92"	27.56" X 78.74"	27.56" X 77.56"	3.703 lbs	2.95" X 33.86" X 4.13"
UQB0T00N82	31.73" X 79.92"	31.50" X 78.74"	31.50" X 77.56"	3.924 lbs	2.95" X 33.86" X 4.13"
UQB0T00N92	35.67" X 79.92"	35.43" X 78.74"	35.43" X 77.56"	4.276 lbs	2.95" X 41.73" X 4.13"
UQB0T00N12	39.61" X 79.92"	39.37" X 78.74"	39.37" X 77.56"	4.453 lbs	2.95" X 41.73" X 4.13"



*W:Width H: Height D: Depth



Newage Quick Banners



Newage Quick Banner displays offer competitive solutions. Suitable to hold banners in thickness of 50 microns / 500 microns. New Age Quick Banner is a flexible and mobile set that can be carried to conventions or exhibitions within its bag.

-  Turning end caps help to slide the poster in.
-  No tool assembly.
-  Product is not recommended for special sizes wider than 39.37" and longer than 78.74". Black carry bag should be ordered extra.

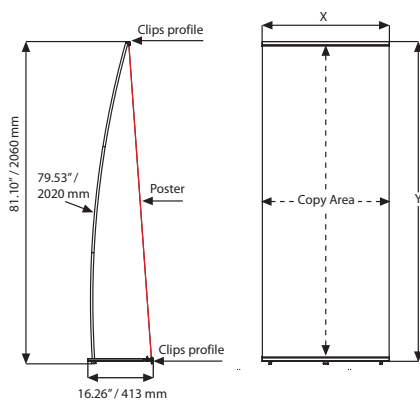
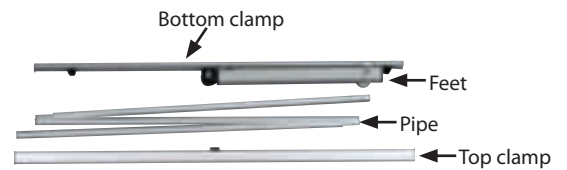

MATERIAL : Silver anodized aluminum				WEIGHT	PACKING SIZE
ARTICLE	EXTERNAL (x-y)	POSTER	COPY	WITH PACKING	*W X H X D
UQBETOON62	23.74" X 79.92"	23.62" X 78.74"	23.62" X 77.56"	2.601 lbs	2.95" X 33.86" X 4.13"
UQBETOON72	27.68" X 79.92"	27.56" X 78.74"	27.56" X 77.56"	2.733 lbs	2.95" X 33.86" X 4.13"
UQBETOON82	31.61" X 79.92"	31.50" X 78.74"	31.50" X 77.56"	2.866 lbs	2.95" X 33.86" X 4.13"
UQBETOON92	35.55" X 79.92"	35.43" X 78.74"	35.43" X 77.56"	3.196 lbs	2.95" X 41.73" X 4.13"
UQBETOON12	39.49" X 79.92"	39.37" X 78.74"	39.37" X 77.56"	3.351 lbs	2.95" X 41.73" X 4.13"



*W:Width H: Height D: Depth

Retractable Roll up Banners



The rolling cylinder comes ready at the point available to place in the work. After the placement of the art work, the cylinder runs immediately once the pin on one end is off. The rolling cylinder can be set up and stretched to the required tightness.

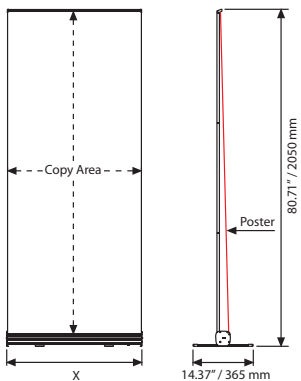

MATERIAL : Silver anodized aluminum				WEIGHT	PACKING SIZE
ARTICLE	POSTER	COPY	X	WITH PACKING	*W X H X D
TWKSRS1085	33.46" X 78.74"	33.46" X 77.56"	34.01"	5.985 lbs	4.92" X 33.86" X 4.92"



*W:Width H: Height D: Depth

Smart Roll Banners (Single Sided)



See movie at our website www.mtdisplays.com.tr



With the latest revision on Smart Roll Banner, M&T concentrated on both design and functionality features. Pipe fixation and improved end caps provide a more stable product and the new revised design gives a more elegant look to the product. The aluminum body is silver anodized stands at min 39.37", max 90.55" height and has a unique telescopic pipe.

Product comes ready to roll-up into black carry bag.

Has unique adjustable telescopic pipe.

Please do not loosen the mechanism when the printing is assembled on the top position.



Improved design



Stable pipe fixation

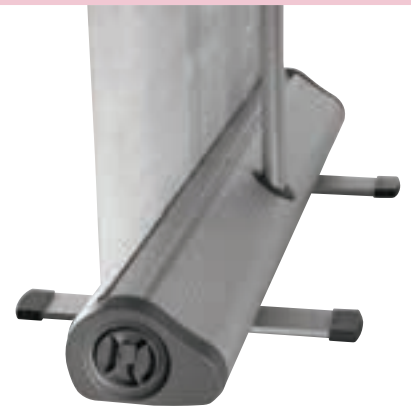

Patent Pending
PCT/TR 2005/000044
EP 05801071
DE 20 2004 021 229
OHIM DM 084 128

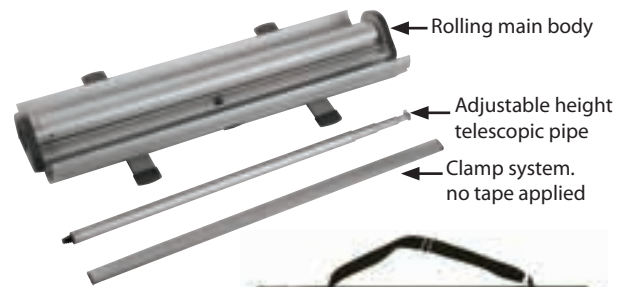

Rolling main body

Adjustable height telescopic pipe

Clamp system. no tape applied



Transport bag

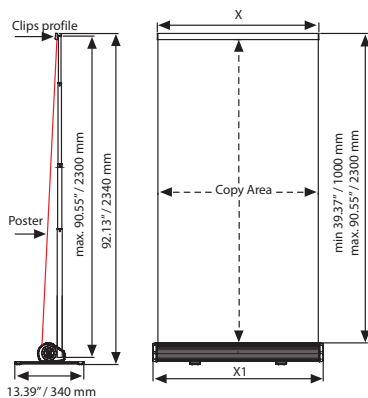

Telescopic Pipe

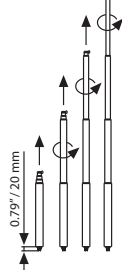

MATERIAL : Silver anodized aluminum			WEIGHT	PACKING SIZE
ARTICLE	X1	POSTER	WITH PACKING	*W X H X D
URBSTOON82	33.46"	31.50"	14.550 lbs	7.09" X 35.83" X 7.09"
URBSTOON92	37.40"	35.43"	15.873 lbs	7.09" X 44.09" X 7.09"
URBSTOON12	41.34"	39.37"	16.975 lbs	7.09" X 44.09" X 7.09"



*W:Width H: Height D: Depth



Smart Roll Banners (Double Sided)



See movie at our website www.mtdisplays.com.tr



The Roll Banner display can be carried together with the printed art work in its carry bag. The aluminum case is silver anodized. Three sizes are available as standard. When assembled it stands at min. 39.37", max. 90.55" high. It has a unique telescopic pipe.

-  Product comes ready to roll-up into black carry bag.
-  Has unique adjustable telescopic pipe.
-  Please do not loosen the mechanism when the printing is assembled on the top position.

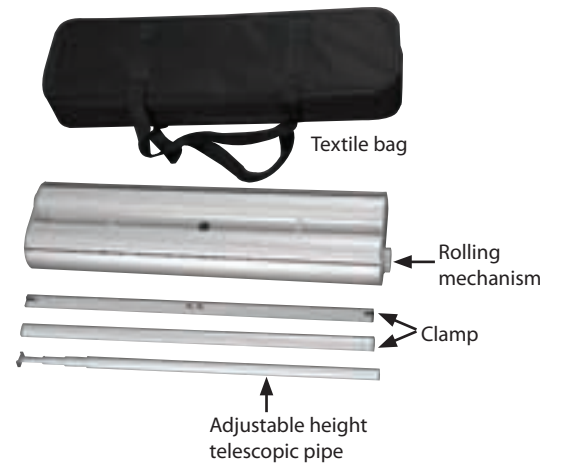

Patent Pending
PCT/TR 2005/000044
EP 05801071
DE 20 2004 021 229

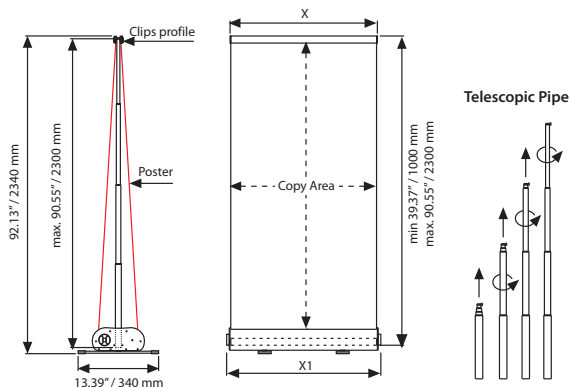

BAG		PACKING SIZE	
ARTICLE	MODEL	*W X H X D	
UYUP070000	31.50"	11.81" X 36.22" X 5.91"	
UYUP071000	39.37"	11.81" X 41.73" X 5.91"	

WEIGHT	PACKING SIZE
WITH BAG&PACKING	*W X H X D
23.148 lbs	11.81" X 36.22" X 5.51"
27.557 lbs	11.81" X 44.09" X 5.51"
29.762 lbs	11.81" X 44.09" X 5.51"

MATERIAL : Silver anodized aluminum					WEIGHT	PACKING SIZE
ARTICLE	EXTERNAL (x)	X1	POSTER	COPY	WITH PACKING	*W X H X D
URBSC00N82	31.73"	33.46"	31.50"	31.50" X 75.98"	18.959 lbs	9.45" X 34.65" X 5.12"
URBSC00N92	35.67"	37.40"	35.43"	35.43" X 75.98"	20.502 lbs	9.45" X 42.52" X 5.12"
URBSC00N12	39.61"	41.34"	39.37"	39.37" X 75.98"	22.046 lbs	9.45" X 42.52" X 5.12"

*W:Width H: Height D: Depth



Easy Swaps



See movie at our website www.mtdisplays.com.tr



Economical and easy touse product. You just put in your PVC foam poster with 0.20" to 0.39" thickness and adjust the nut from the bottom part of the aluminum box. It can be used in all indoor areas such as schools, seminars, restaurants, showrooms, exhibition areas, malls and everywhere else.

Packed with an easy to understand instruction sheet.

To change the poster boards, please loosen the nut under the aluminum box.

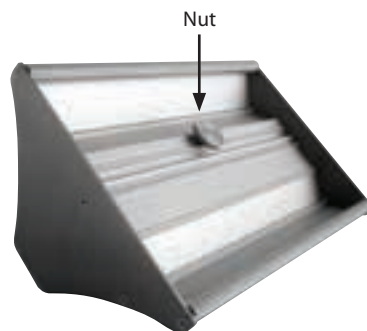
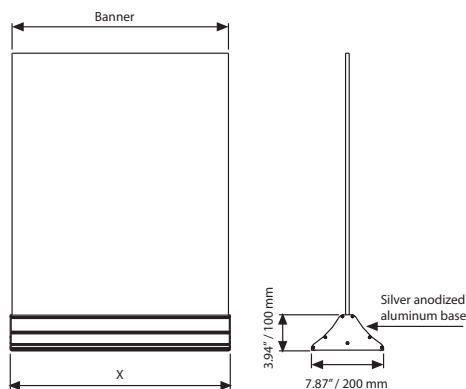

MATERIAL : Silver anodized aluminum			WEIGHT	PACKING SIZE
ARTICLE	EXTERNAL (x)	POSTER	WITH PACKING	*W X H X D
UMS0100300	12.20"	11.81"	4.409 lbs	8.66" X 13.39" X 4.61"
UMS0100600	24.02"	23.62"	6.834 lbs	8.66" X 25.20" X 4.61"
UMS0100800	31.89"	31.50"	11.816 lbs	8.66" X 33.07" X 4.61"
UMS0100900	35.83"	35.43"	13.293 lbs	8.66" X 37.01" X 4.61"
UMS0101000	39.76"	39.37"	14.770 lbs	8.66" X 40.94" X 4.61"
UMS0101200	47.64"	47.24"	17.725 lbs	8.66" X 48.82" X 4.61"
UMS0101500	59.45"	59.06"	22.156 lbs	8.66" X 60.63" X 4.61"

*W:Width H: Height D: Depth



Poster Traps



See movie at our website www.mtdisplays.com.tr



The system is mainly based on screwing the 2 pieces of the bases to each other to stand the poster still. Adjustable thickness of poster. The maximum height of poster is 59.06". Base is double sided. Suitable for all areas.

Packed with an easy to understand instruction sheet.

The holes on the substrate should be 0.35" diameter

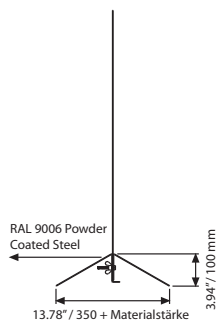
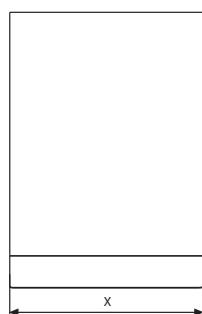

Tolerance for the holes

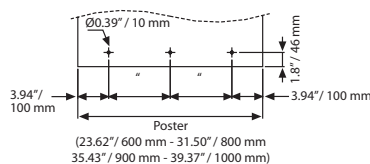
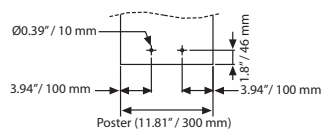

MATERIAL : Silver anodized aluminum		WEIGHT	PACKING SIZE
ARTICLE	EXTERNAL (x)	POSTER	*W X H X D
UMS0000300	11.81"	11.81"	7.627 lbs 8.07" X 12.99" X 4.61"
UMS0000600	23.62"	23.62"	13.778 lbs 8.07" X 24.80" X 4.61"
UMS0000800	31.50"	31.50"	17.857 lbs 8.07" X 32.68" X 4.61"
UMS0000900	35.43"	35.43"	20.502 lbs 8.07" X 36.61" X 4.61"
UMS0001000	39.37"	39.37"	22.928 lbs 8.07" X 40.55" X 4.61"



* W:Width H: Height D: Depth



Optima Banners



See movie at our website www.mtdisplays.com.tr



As a retractable poster display system, Optima Roll banners are made with the finest materials and craftsmanship. It is easy to operate and requires no tools to set up. Each banner stand features a retractable system which protects poster during transportation. The base houses the poster and feet and furthermore and keeps them protected when not in use. Removable retractable system is ideal for applications where the message changes regularly. Screwed-in pipe holds the poster firm in place.

-  Product comes ready to roll-up with into gray solid transport bag included.
-  Has unique removable retractable body.
-  No tool assembly. Please do not loosen the mechanism when the printing is assembled on the top position.



OHIM DM 084 128



Screwed-in stable pipe



Solid bag transport

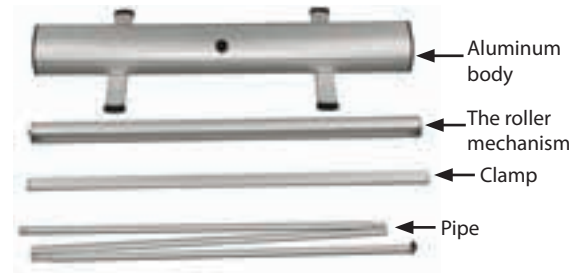

Aluminum body

The roller mechanism

Clamp

Pipe

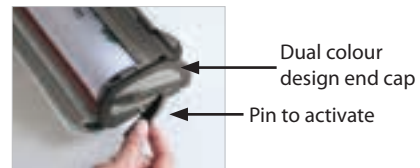

Dual colour design end cap

Pin to activate

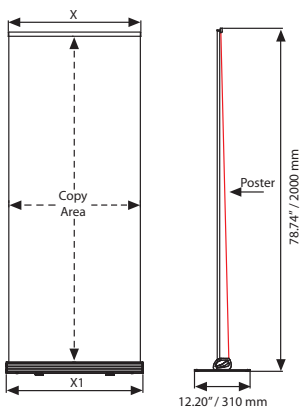

MATERIAL : Silver anodized aluminum						WEIGHT	PACKING SIZE
ARTICLE	EXTERNAL (x-y)	POSTER	COPY	X1	DESCRIPTION	WITH PACKING	*W X H X D
URB001N082	31.73"	31.50" X 78.74"	31.50" X 77.56"	32.91"	with bag	11.023 lbs	6.30" X 35.43" X 5.12"
URB001N092	39.61"	35.43" X 78.74"	35.43" X 77.56"	40.79"	with bag	12.566 lbs	6.30" X 43.31" X 5.12"
URB001N242	24.24"	24" X 78.74"	24" X 77.56"	25.42"	with bag	9.920 lbs	5.5" X 27.17" X 5.51"
URB001N362	36.24"	36" X 78.74"	36" X 77.56"	37.42"	with bag	12.345 lbs	5.51" X 39.17" X 5.51"

*W:Width H: Height D: Depth



Eco Roll Banners



See movie at our website www.mtdisplays.com.tr



The rolling cylinder comes ready at the point available to place in the art work. After the placement of the art work, the cylinder runs immediately once the pin on one end is off. The rolling cylinder can be set up and stretched in the required tightness.

Product comes unassembled, packed with an easy-to-understand instruction sheet.

Stainless aluminum legs are suitable for public spaces.

Black carry bag should be ordered separately.

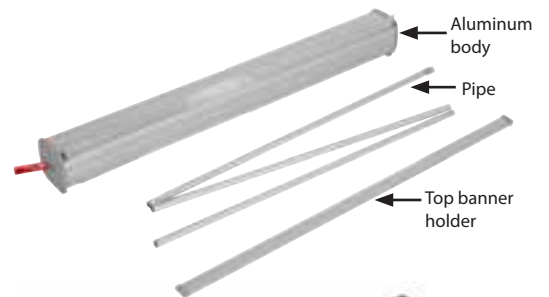

Bag for Eco Roll Banner

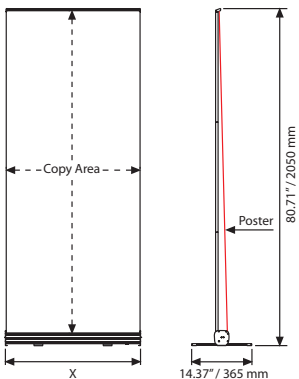

MATERIAL : Silver anodised aluminium				WEIGHT	PACKING SIZE
ARTICLE	POSTER	COPY	X	WITH PACKING	*W X H X D
URBETO0N82	31.50" X 78.75"	31.50" X 77.56"	32.28"	5.423 lbs	4.33" X 33.86" X 4.33"
URBETO0N12	39.37" X 78.75"	39.37" X 77.56"	40.16"	6.393 lbs	4.33" X 41.73" X 4.33"

BAG		PACKING SIZE
ARTICLE	MODEL	*W X H X D
UYUP070500	31.50"	
UYUP070600	39.37"	



*W:Width H: Height D: Depth

Super Eco Roll Banners



Pipe fixation and improved end caps provide a more stable to our Super Eco Roll Banner. The new revised design gives a more elegant look to the product. The aluminum body is silver anodized. Stands at 78.75" high. Has a unique collapsable pipe.

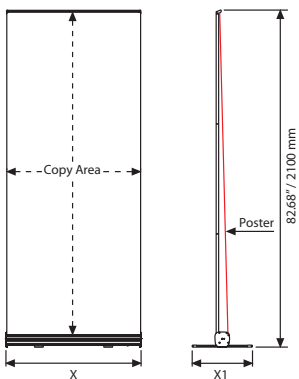

MATERIAL : Silver anodized aluminum						WEIGHT	PACKING SIZE
ARTICLE	POSTER	COPY	DESCRIPTION	X	X1	WITH PACKING	*W X H X D
TSZBSE8001	31.50" X 78.74"	31.50" X 77.56"	With bag	32.01"	9.25"	3.880 lbs	4.53" X 33.86" X 4.53"
TSZBSE1001	39.37" X 78.74"	39.37" X 77.56"	With bag	40.55"	13.19"	4.585 lbs	4.53" X 41.73" X 4.53"
TSZBSE6101	24.02" X 78.74"	24.02" X 77.56"	With bag	24.53"	9.25"	3.593 lbs	4.53" X 25.98" X 4.53"
TSZBSE9151	36.02" X 78.74"	36.02" X 77.56"	With bag	36.54"	13.19"	4.144 lbs	4.53" X 38.39" X 4.53"
TSZBSE1221	48.03" X 78.74"	48.03" X 77.56"	With bag	48.54"	17.13"	5.908 lbs	4.53" X 50.59" X 4.53"

*W:Width H: Height D: Depth





Printable Solutions

- Maxi Frames
 - River Maxi Frame
 - Bay Maxi Frame
 - Gulf Maxi Frame
 - Lagoon Maxi Frame
 - Ocean Maxi Frame
- Maxi Frame with LED
 - Star Maxi LED
 - Power LED
 - Maxi Frame Totem with LED
 - Semi Products for Maxi Frame
 - Omni Frame
 - Omni A Board

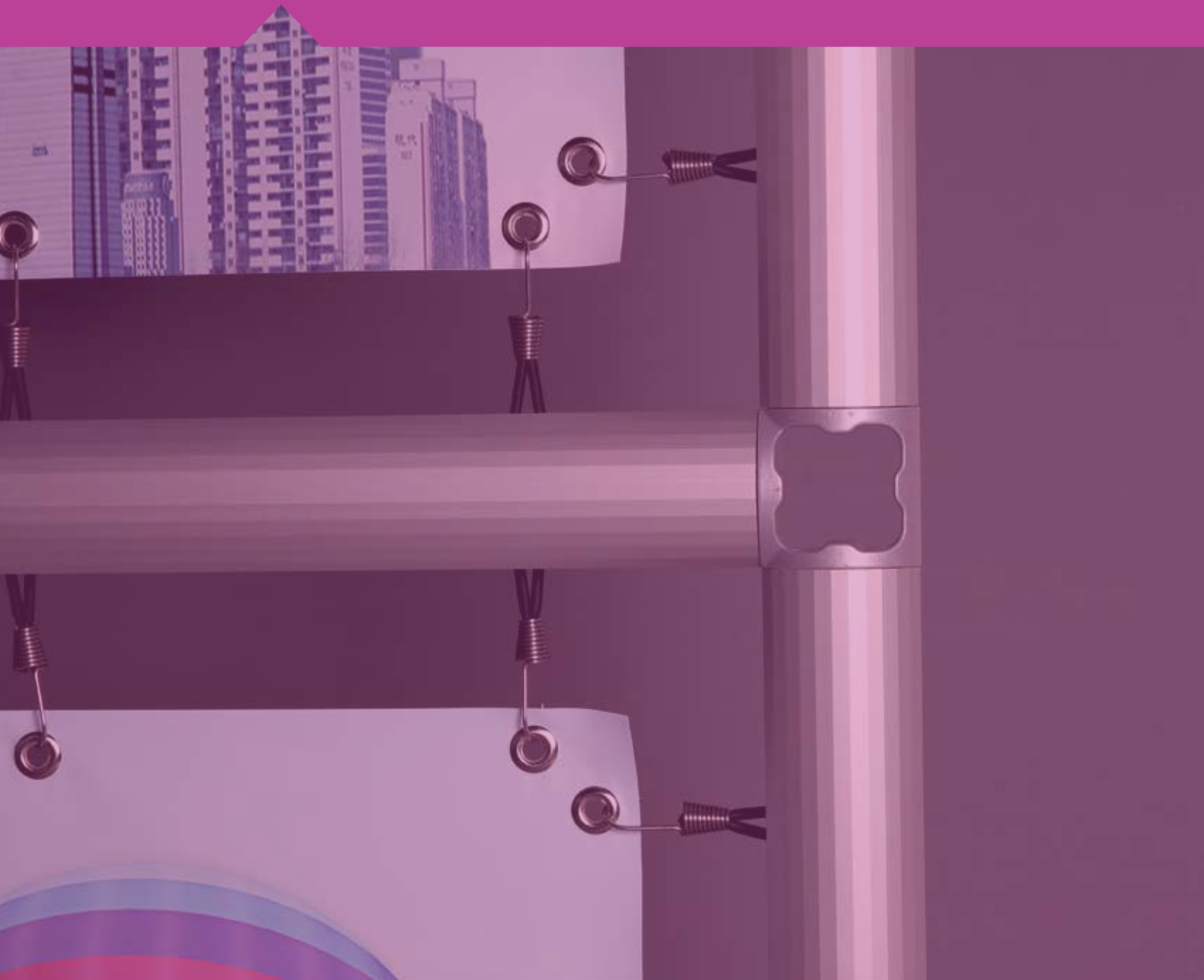

Maxi Frames



It offers a fresh new look to today's display atmosphere which is an alternative to frame systems, Banners, Pop-Ups by applying a printed fabric's installation into the Maxi profile with a sewed or taped nylon strip. The product is a stunning combination of Aluminum and Digital Printing Machines where they unite with a fabric. The attractive point of the product is when it is looked at the front side, you are unable to see the Aluminium Parts of the frame which makes it look frameless.

The details of packaging of the product are:

- All the MAXI FRAMES are individually packed.
- Profiles and connector parts for the required sizes are boxed unassembled.
- Nylon strip is included in each frame.
- Fixing tools are included in each package. Just the feet for Double Sided Ocean Maxi frame must be ordered separately and 4 feet models are available.

Our Maxi Frame Range consists of mainly 5 different profile options. These profiles are designed to make 3 different models of Single Sided MAXI FRAMES, and 2 models of Double Sided MAXI FRAMES. Our standard Maxi Frames are always supplied unassembled providing connectors, hanging parts, and nylon strips. For the double sided ceiling hanger model the hanging wire cable system in each box. Please note, ceiling hanger and 4 feet options should be ordered separately.

Maxi Frame LED Product Programme (Production & Availability)

Size Available	25 mm / Star Maxi LED	50 mm / Star Maxi LED	34 mm / Maxi Frame
Poster Size	single	double	single
23 - 20" x 30"	UMLSTN0023	UMLSCN0023	UMLD340023
34 - 30" x 40"	UMLSTN0034	UMLSCN0034	UMLD340034
46 - 40" x 60"	X	X	UMLD340046
Max (w x h) inch	33.46" x 47.24"	33.46" x 78.74"	47.24" x 95.07"

Power Consumption	25 mm / Star Maxi LED	50 mm / Star Maxi LED	34 mm / Maxi Frame
Poster Size	single	double	single
23 - 20" x 30"	18,5W / 1,55A	23W / 1,9A	31W / 2,6A
34 - 30" x 40"	26W / 2,1A	29W / 2,4A	39,5W / 3,3A
46 - 40" x 60"	X	X	58W / 4,85A

Power Supply Recommended (12 Vdc, Ampere)	25 mm / Star Maxi LED	50 mm / Star Maxi LED	34 mm / Maxi Frame
Poster Size	single	double	single
23 - 20" x 30"	2A	3A	4A
34 - 30" x 40"	3A	4A	4A
46 - 40" x 60"	X	X	6A

LUX	25 mm / Star Maxi LED	50 mm / Star Maxi LED	34 mm / Maxi Frame
Poster Size	single	double	single
23 - 20" x 30"	1200 - 1500	800 - 1200	2600 - 3000
34 - 30" x 40"	900 - 1000	800 - 1000	1700 - 2000
46 - 40" x 60"	X	X	1400 - 1800

- ✓ Standard colour: Silver Anodised
- ✓ Available in RAL colours (subject to MOQ)
- ✓ Power supply is provided with the unit to suit each of the product
- ✓ Luminance: 2000-3000lux (depending on size)
- ✓ Standard Packaging: Single units in polybag and box
- ✓ Low power consumption (see above average power consumption table for each size)
- ✓ Various plugs available such as European, UK, US and Australian
- ✓ Complies with EN55015 & EN61547.

POWER SUPPLY	
ARTICLE	DESCRIPTION
UYPLD00010	Power supply EU 3,34A 7/24
UYPLD00011	Power supply EU 6,67A 7/24
UYPLD00012	Power supply EU 8,5A 7/24
UYPLD00013	Power supply EU 11,5A 7/24

- ✓ Products are suitable to use 7/16.
- ✓ If 7/24 use required, please order individually as 7/24 power supplies as below:

 In case of any claim, user is required to return product or any parts to manufacture for analyses at their cost. As long as the manufacturer confirms the problem is a manufacturing fault, the replacement can be provided. This applies for all illuminated products.



Maxi Frames



Single Sided MAXI FRAMES are provided in 3 different profiles in order of thickness:

a) Valet Profile: 15x22 mm profile. The Single Sided MAXI FRAMES made up with Valet Profile are named as RIVER MAXI FRAMES. Available Poster Sizes are: A4, A3, A2, A1, B2, B1, and 50x100cm.

b) Ace Profile: 32x8mm profile. The Single Sided MAXI FRAMES made up with Ace Profile are named as BAY MAXI FRAMES. Available Poster Sizes are: A4, A3, A2, A1, A0, B2, B1, B0, 50x10cm., 100x100cm., 100x150cm., and 100x200cm.

c) Dame Profile: 34x32 mm profile. The Single Sided MAXI FRAMES made up with Dame Profile are named as GULF MAXI FRAMES. Available Poster Sizes are: 100x200cm., 100x300cm., 150x200cm., 150x300cm., 200x200cm., and 200x300cm.

Double Sided MAXI FRAMES are provided in 2 different profiles.

a) Queen Profile: 45x15 mm profile - Suitable for ceiling suspension. The Double Sided MAXI FRAMES made up with Queen Profile are named as LAGOON MAXI FRAMES. Available Poster Sizes are: A4, A3, A2, A1, A0, B2, B1, B0, 50x10cm., 100x100cm., 100x150cm., and 100x200cm.

b) King Profile: 50x40 mm profile - Designed with feet for free standing. The Double Sided MAXI FRAMES made up with King Profile are named as OCEAN MAXI FRAMES. Available Poster Sizes are: 100x140cm., 100x150cm., 100x200cm., 100x225cm., 200x150cm., 200x200cm., 200x225cm., 300x150cm., 300x200cm., and 300x225cm.

We offer MAXI FRAMES both in standard sizes boxed unassembled and also in lengths and parts as semi products.

Find below all the Semi-Products that are used in MAXI FRAMES.

Clear Nylon Strip, Corner Cleat for MAXI FRAMES, Straight Cleat for H-Profile of MAXI FRAME, Square Corner Connector for MAXI FRAME, L-Type Corner Connector for MAXI FRAME, Hanging System including wire cable, Transparent or Gray Color Pull strip.

Find below the names of 4 different feet models: Circle Feet, Hoop Feet, Baseball Feet, and Fillet Feet.



River Maxi Single Sided



Valet Profile / 0.59"x0.87" River Maxi Frame

The single-sided MAXI FRAMES that are made up of Valet Profile are named RIVER MAXI FRAMES.



Hang by using the assembling holes.



The thickness of the channel is 0.16". Supplied nylon strip is 0.12", recommended fabric thickness for digital printing is 0.02". The pull sticker in 0.02" thickness must be sewed on the fabric to take out the poster from channels.



0.51" on each side of the fabric into Maxi Profiles, in total 1.02" on each Fabric Poster is not seen on the poster. Please arrange accordingly. Fabric is not included within the original pack.

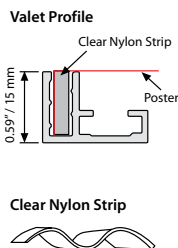
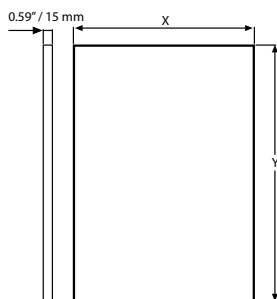

Suggested additional print shares for Maxi Frame's Fabric Posters

Between 7.87" - 29.53"	1.10"
Between 29.53" - 59.06"	0.79"
Between 59.06" - 118.11"	0.59"

e.g. Maxi frame size: 39.37"x11.81"
printed fabric size must be 40.16"x12.91".
But these values might vary according to
the fabric material used.

MATERIAL : Silver anodised aluminium		WEIGHT	PACKING SIZE
ARTICLE	EXTERNAL (x-y)	WITH PACKING	*W X H X D
UMFR000017	11" X 17"	1.399 lbs	2.36" X 18.90" X 1.57"
UMFR000018	18" X 24"	1.851 lbs	2.36" X 25.98" X 1.57"
UMFR000022	22" X 28"	2.149 lbs	2.36" X 30.31" X 1.57"
UMFR000024	24" X 36"	2.458 lbs	2.36" X 37.99" X 1.57"
UMFR000074	27" X 40"	2.623 lbs	2.36" X 41.93" X 1.57"

* W:Width H: Height D: Depth



Bay Maxi Single Sided



Ace Profile / 1.26"x0.31" Bay Maxi Frame

The single-sided MAXI FRAMES that are made up of Ace Profile are named BAY MAXI FRAMES.

Hang by using the Square Corner Connector pieces. For larger sizes of Bay Maxi Frame, H-Profile is included in the pack with the quantities shown in the table.

The thickness of the channel is 0.16". Supplied nylon strip is 0.12", so recommended fabric thickness for digital printing is 0.02". The pull sticker in 0.02" thickness must be sewed on the fabric for taking out the poster when fitted into the channels.

0.51" on each side of the fabric is fitted into Maxi Profiles, so 1.02" on each Fabric poster is not seen on the poster. Please arrange accordingly. Fabric is not included within the original pack.

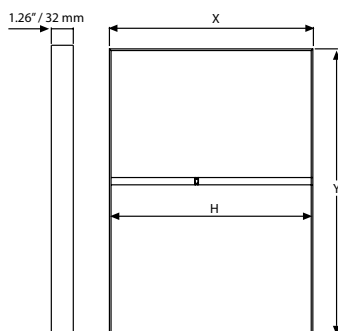

Ace Profile

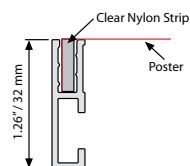

Clear Nylon Strip

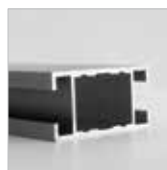
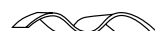

H profile / UYUP014106

MATERIAL : Silver anodised aluminium				WEIGHT	PACKING SIZE
ARTICLE	EXTERNAL (x-y)	H (mm)	H (Pcs)	WITH PACKING	*W X H X D
UMFB000017	11" X 17"	-	-	1.565 lbs	2.36" X 18.90" X 1.97"
UMFB000018	18" X 24"	-	-	1.807 lbs	2.36" X 25.98" X 1.97"
UMFB000022	22" X 28"	-	-	2.535 lbs	2.36" X 30.31" X 1.97"
UMFB000024	24" X 36"	-	-	2.888 lbs	2.36" X 37.99" X 1.97"
UMFB000036	36" X 48"	-	-	3.858 lbs	2.36" X 50" X 1.97"
UMFB000046	40" X 60"	39.33"	1	6.172 lbs	2.36" X 61.01" X 1.97"

*W:Width H:Height D:Depth



Gulf Maxi Single Sided

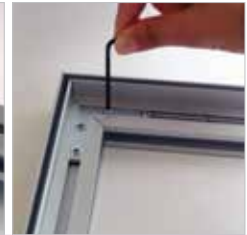
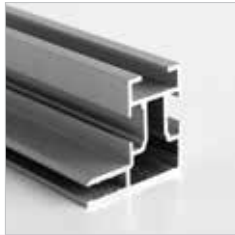

Dame Profile / 1.34"x1.26" Gulf Maxi Frame

The single-sided MAXI FRAMES that are made up of Dame Profile are named GULF MAXI FRAMES.



Hang by using the assembling holes. The profile edges have corner cleats and are connected by allen key. For larger sizes of Gulf Maxi Frame, H-Profile is included in the pack with the quantities shown in the table.



The thickness of the profile is 0.16". Supplied nylon strip is 0.12"; so recommended fabric thickness for digital printing is 0.02". The pull sticker in 0.02" thickness must be sewed on the fabric for taking out the poster when fitted into the channels.



0.51" on each side of the fabric is fitted into Maxi Profiles, so 1.02" on each Fabric Poster is not seen on the poster. Please arrange accordingly. Fabric is not included within the original pack.

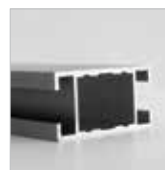
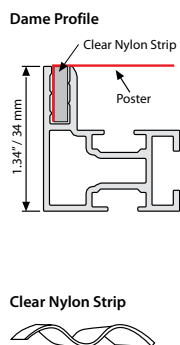
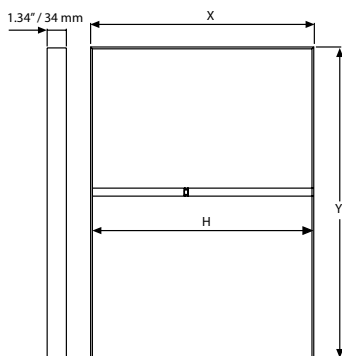
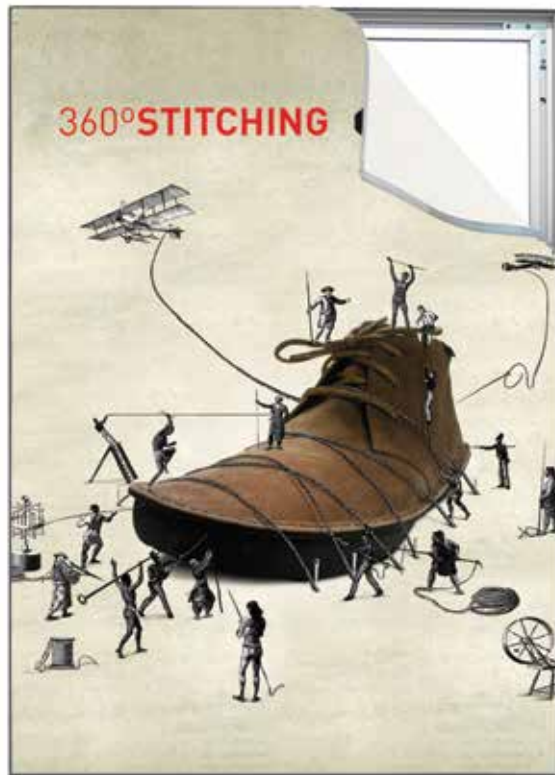

H profile / UYUP014106

MATERIAL : Silver anodised aluminium				WEIGHT	PACKING SIZE
ARTICLE	EXTERNAL (x-y)	H (mm)	H (Pcs)	WITH PACKING	*W X H X D
UMFG004060	40" X 60"	-	-	8.267 lbs	4.33" X 62.01" X 2.36"
UMFG004080	40" X 80"	-	-	9.479 lbs	4.33" X 81.89" X 2.36"
UMFG004718	47" X 118"	49.53"	1	17.636 lbs	4.33" X 120.08" X 2.36"
UMFG008018	80" X 118"	77.48"	1	24.691 lbs	4.33" X 120.08" X 2.36"

*W:Width H: Height D: Depth



Lagoon Maxi Double Sided



Queen Profile / 1.77"x0.59" Lagoon Maxi Frame

Used for ceiling hanging. The double-sided MAXI FRAMES that are made up of Queen Profile are named LAGOON MAXI FRAMES.

Suitable to hang from the ceiling. The profiles are connected to each other by the help of Square Corner Connector piece. For larger sizes of Lagoon Maxi Frame, H-Profile must be used. The special hanging pieces for fixing the ceiling with the wire cable, must be fixed into the top short side of the Lagoon Maxi Frame before the profiles are connected to each other.

The thickness of the profile is 0.16". Supplied nylon strip is 0.12", so recommended fabric thickness for digital printing is 0.02". The pull sticker in 0.02" thickness must be sewed on the fabric for taking out the poster when fitted into the channels.

0.51" on each side of the fabric is fitted into Maxi Profiles, so 1.02" on each Fabric Poster is not seen on the poster. Please arrange accordingly. Fabric is not included within the original pack. Ceiling hangers are included in the original pack.



Hanging kit / UYUP460245

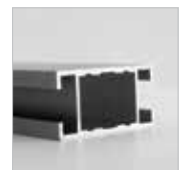

H profile / UYUP014106

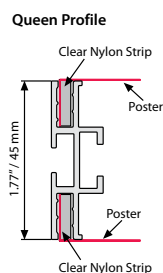
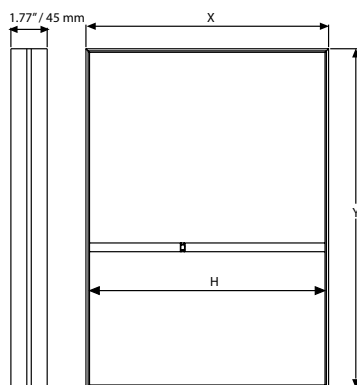

MATERIAL : Silver anodised aluminium				WEIGHT	PACKING SIZE
ARTICLE	EXTERNAL (x-y)	H (mm)	H (Pcs)	WITH PACKING	*W X H X D
UMFL000017	11" X 17"	-	-	2.248 lbs	3.35" X 18.90" X 2.95"
UMFL000018	18" X 24"	-	-	3.284 lbs	3.35" X 25.98" X 2.95"
UMFL000022	22" X 28"	-	-	4.188 lbs	3.35" X 30.31" X 2.95"
UMFL000024	24" X 36"	-	-	4,850 lbs	3.35" X 37.99" X 2.95"
UMFL000036	36" X 48"	-	-	6.062 lbs	3.35" X 50" X 2.95"
UMFL000046	40" X 60"	38.82"	1	8.245 lbs	3.35" X 62.01" X 2.95"

*W:Width H:Height D:Depth



Ocean Maxi

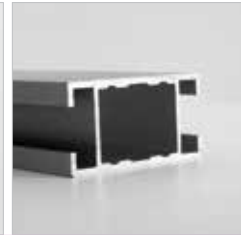
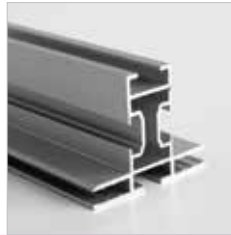

See movie at our website www.mtdisplays.com.tr

King Profile / 1.97"x1.57"

Ocean Maxi Frame

Used with feet to be placed on a floor. The double-sided MAXI FRAMES that are made up of King Profile are named OCEAN MAXI FRAMES. Ocean Frame can be assembled with 4 different feet models. Before the assembly of the profile corners, the connector pieces for the feet need to be fitted into the profiles channels. Then, the feet are assembled over these connector pieces.

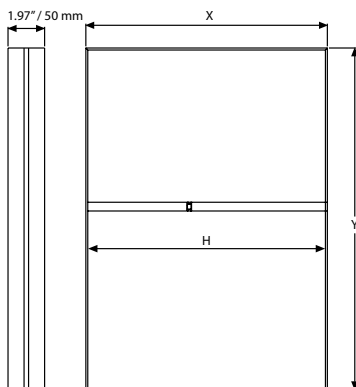
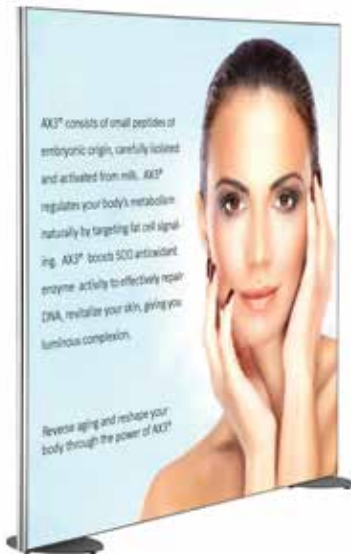

King Profile

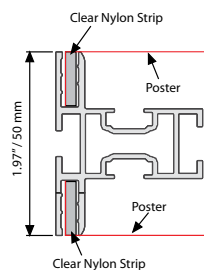

Clear Nylon Strip



MATERIAL : Silver anodised aluminium				WEIGHT	PACKING SIZE
ARTICLE	EXTERNAL (x-y)	H (mm)	H (Pcs)	WITH PACKING	*W X H X D
UMFO004060	40" X 60"	-	-	11.816 lbs	5.51" X 62.01" X 4.33"
UMFO006040	60" X 40"	-	-	11.816 lbs	5.51" X 62.01" X 4.33"
UMFO008790	87" X 90"	83.86"	1	21.274 lbs	5.51" X 92.13" X 4.33"
UMFO001090	100" X 90"	86.85"	1	23.038 lbs	5.51" X 101.97" X 4.33"
UMFO001290	120" X 90"	86.85"	2	28.968 lbs	5.51" X 122.05" X 4.33"
UMFO001890	118" X 90"	86.85"	2	28.660 lbs	5.51" X 120.08" X 4.33"

*W:Width H: Height D: Depth



Ocean Maxi



See movie at our website www.mtdisplays.com.tr



It can be used in 2 ways either by hanging to the ceiling or by fitting on 4 different designs of feet. The profiles edges have corner cleats and connected by allen key. For larger sizes of Ocean Maxi Frame, H-Profile must be used for stability. The special hanging pieces for fixing the ceiling with the wire cable, need be fixed into the top short side of the Ocean Maxi Frame before the profiles are connected to each other.



The thickness of the profile is 0.16". Supplied nylon strip is 0.12", so recommended fabric thickness for digital printing is 0.02". The pull sticker in 0.02" thickness must be sewed on the fabric for taking out the poster when fitted into the channels.



0.51" on each side of the fabric is fitted into Maxi Profiles, so as overall 1.02" on each fabric poster is not seen on the poster. Please arrange accordingly. Fabric is not included within the original pack. Feet and ceiling hangers are not included in the original pack, please remember to place a separate order.

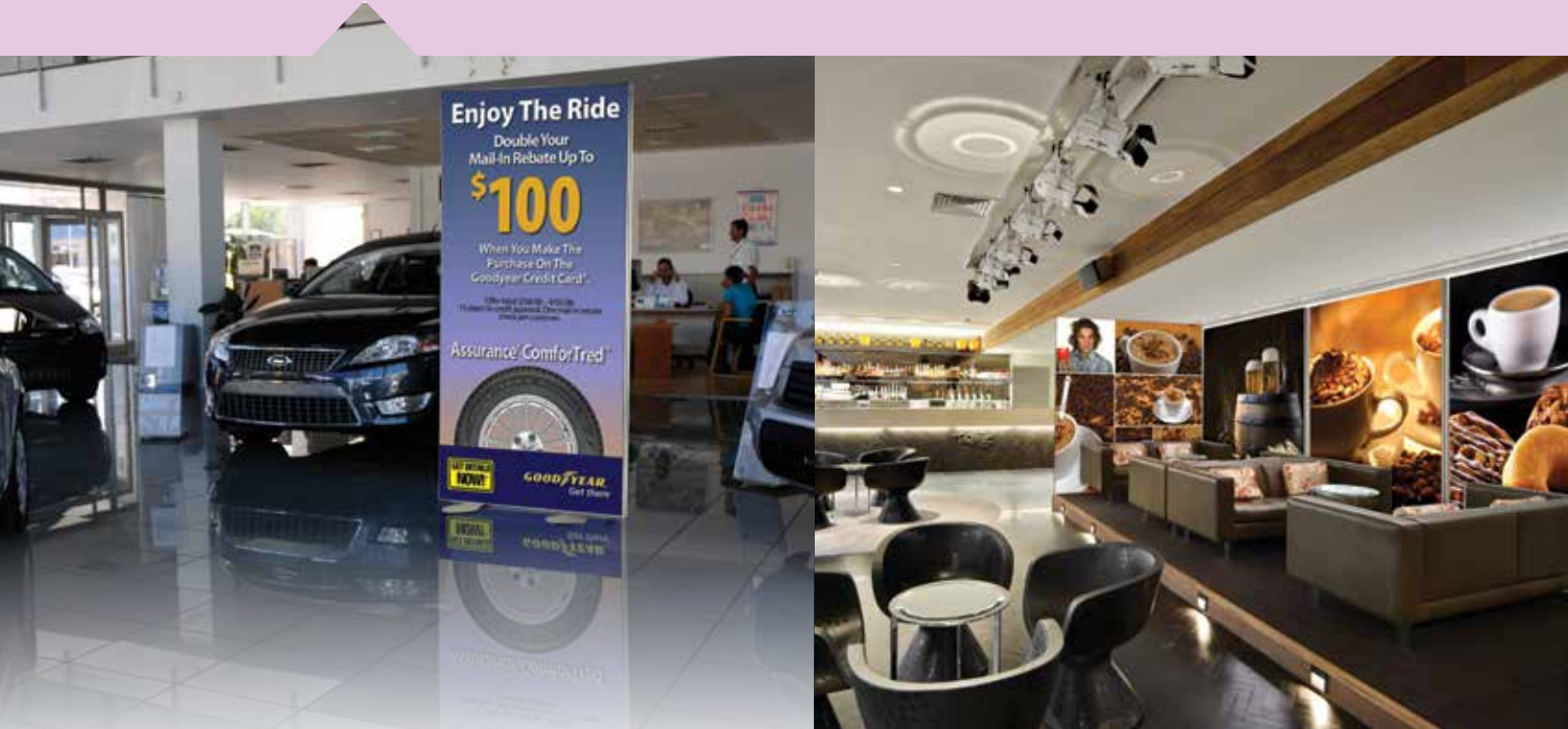

Assembly of King Profile / Montage des King Profils



Assembly of H Profile / Montage der Quertraversen



BASEBALL FEET : RAL 9006 Powder coated, 0.24" steel.		
ARTICLE	SIZE	WEIGHT
UYUP412273	17.72" X 11.81" X 0.24"	10.361 lbs



HOOP FEET : RAL 9006 Powder coated, 0.24" steel.		
ARTICLE	SIZE	WEIGHT
UYUP412272	Ø17.72" X 0.24"	9.700 lbs



CIRCLE FEET : RAL 9006 Powder coated, 0.24" steel.		
ARTICLE	SIZE	WEIGHT
UYUP412271	Ø17.72" X 0.24"	16.534 lbs



FILLET FEET : RAL 9006 Powder coated, 0.24" steel.		
ARTICLE	SIZE	WEIGHT
UYUP412274	19.69" X 7.09" X 0.24"	7.275 lbs

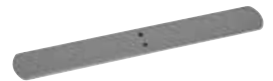

FLAT FEET : RAL 9006 Powder coated, 0.20" steel.	
ARTICLE	SIZE
UYUP412275	15.75" X 19.70" X 0.20"

Maxi Frame with LED



Dame Profile / 1.34"x1.26" Maxi Frame with LED

Used with wall mounting fixture on the back. The unit is single sided & edge-lit. Pre-treated light guided panel diffuses light even & powerful. Offers evenly diffused lux in all sizes.

All units pass CE/UL Pat test and packed with quality certificates. 137.80" electrical cable. UK and US plugs should be mentioned on order.

The thickness of the profile is 0.16". Supplied nylon strip is 0.12"; so recommended fabric thickness for digital printing is 0.02". The pull sticker in 0.02" thickness must be sewed on the fabric for taking out the poster when fitted into the channels.

0.51" on each side of the fabric is fitted into Maxi Profiles, so 1.02" on each Fabric Poster is not seen on the poster. Please arrange accordingly. Fabric is not included within the original pack.

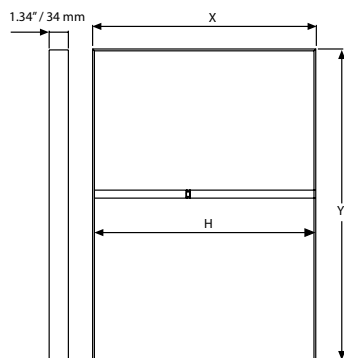

Dame Profile

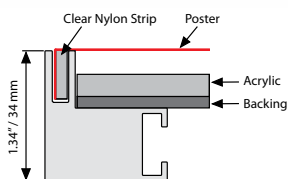

Clear Nylon Strip



MATERIAL : Silver anodised aluminium					WEIGHT	PACKING SIZE
ARTICLE	EXTERNAL (x-y)	H (mm)	H (Pcs)	LIGHTING	WITH PACKING	*W X H X D
UMLD340018	18" X 24"	-	-	2200-2500 LUX	11.243 lbs	18.90" X 25.59" X 1.69"
UMLD340022	22" X 28"	-	-	2300-2700 LUX	14.991 lbs	22.83" X 29.53" X 1.69"
UMLD340023	20" X 30"	-	-	2600-2800 LUX	14.991 lbs	20.87" X 31.50" X 1.69"
UMLD340024	24" X 36"	-	-	2600-2800 LUX	19.400 lbs	34.80" X 37.80" X 1.69"
UMLD340034	30" X 40"	-	-	1900-2100 LUX	23.809 lbs	31.10" X 41.34" X 1.69"
UMLD340036	36" X 48"	-	-	2000-2200 LUX	33.951 lbs	36.81" X 49.61" X 1.69"
UMLD340046	40" X 60"	37.48"	1	1900-2300 LUX	45.194 lbs	40.94" X 61.42" X 1.69"

*W:Width H: Height D: Depth



Star Maxi LED Single Sided



See movie at our website www.mtdisplays.com.tr



With its very slim profile, 0.94", Star Maxi LED is a modern way of advertising. It is suitable for textile printed graphics. Practical poster application with clear tape provides smooth look. Complete with wall mounting accessories, Star Maxi LED is a practical advertising solution.

- All units pass CE/UL Pat test and packed with quality certificates. 11 ft. electrical cable. UK and US plugs should be mentioned on order
- The width of the channel is 0.16". Supplied nylon strip is 0.12", so recommended fabric thickness for digital printing is 0.02". The pull sticker in 0.02" thickness must be sewed on the fabric for taking out the poster when fitted into the channels.
- 0.51" on each side of the fabric is fitted into Maxi Profiles, so 1.02" on each Fabric Poster is not seen on the poster. Please arrange accordingly. Fabric is not included within the original pack.



Portrait

One product, two positions (landscape & portrait)



Landscape



2 wall hangers are standard in each product. Moving hangers let the mounting in portrait and landscape position.



Optional dimmer to go with LED illuminated frame.. Simply jack the dimmer in frame and then into powersupply. It adjust the light from dark to max lux of LED illuminated frame.

CE/UL approved.

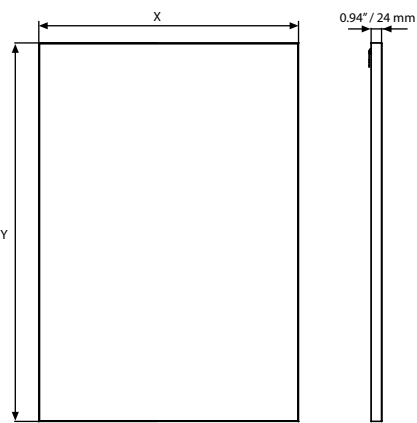

Clear nylon strip
Please don't forget to order.
Including 7/16 power supply.

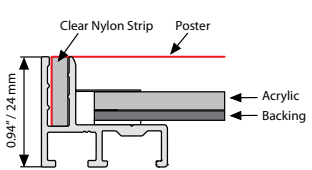

MATERIAL : Silver anodised aluminium			WEIGHT	PACKING SIZE
ARTICLE	EXTERNAL (x-y)	LIGHTING	WITH PACKING	*W X H X D
UMLSTN0018	18" X 24"	2500-2700 LUX	5.952 lbs	20" X 28.35" X 2.95"
UMLSTN0022	22" X 28"	2400-2600 LUX	8.377 lbs	23.98" X 32.36" X 2.95"
UMLSTN0023	20" X 30"	2300-2600 LUX	8.157 lbs	21.97" X 34.33" X 2.95"
UMLSTN0024	24" X 36"	2200-2500 LUX	11.904 lbs	25.98" X 40.35" X 2.95"
UMLSTN0034	30" X 40"	2200-2500 LUX	21.605 lbs	37.99" X 44.33" X 2.95"
UMLSTN0036	36" X 48"	2100-2400 LUX	23.368 lbs	37.99" X 52.36" X 2.95"
UMLSTN0046	40" X 60"	2100-2400 LUX	32.187 lbs	41.97" X 64.33" X 2.95"

*W:Width H: Height D: Depth



Star Maxi LED Double Sided



See movie at our website www.mtdisplays.com.tr



With its slim profile, 50mm, double sided Star Maxi LED is a modern way of advertising. It is suitable for textile printed graphics. Practical poster application with clear tape provides smooth look. Complete with ceiling suspension system, Star Maxi LED is a practical advertising solution when message is required to be displayed both ways.



All units pass CE/UL Pat test and packed with quality certificates. 11 ft. electrical cable. UK and US plugs should be mentioned on order



The width of the channel is 0.16". Supplied nylon strip is 0.12", so recommended fabric thickness for digital printing is 0.02". The pull sticker in 0.02" thickness must be sewed on the fabric for taking out the poster when fitted into the channels.



0.51" on each side of the fabric is fitted into Maxi Profiles, so 1.02" on each Fabric Poster is not seen on the poster. Please arrange accordingly. Fabric is not included within the original pack.

One product,
two positions
(landscape&portrait)



Portrait

CE/UL approved.



Landscape

Including suspension kit.

78.74" / 2 meter

1.97" / 50 mm depth



Standard hanging kit for all sizes: 78.74" x 2 pcs wire cable and 2 ceiling hangers.



Optional dimmer to go with LED illuminated frame.. Simply jack the dimmer in frame and then into powersupply. It adjust the light from dark to max lux of LED illuminated frame.

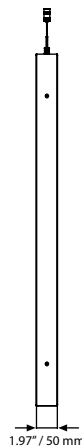
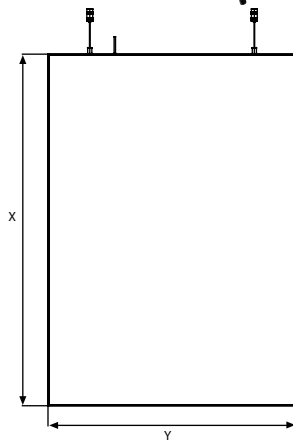

Clear nylon stript
Please don't forget to order.
Including 7/16 power supply.

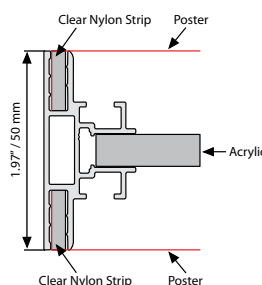

MATERIAL : Silver anodised aluminium			WEIGHT	PACKING SIZE
ARTICLE	EXTERNAL (x-y)	LIGHTING	WITH PACKING	*W X H X D
UMLSCN0018	18" X 24"	2700-3300 LUX	8.598 lbs	20" X 28.35" X 3.74"
UMLSCN0022	22" X 28"	2700-3300 LUX	12.345 lbs	23.98" X 32.36" X 3.74"
UMLSCN0023	20" X 30"	2700-3200 LUX	12.345 lbs	21.97" X 34.33" X 3.74"
UMLSCN0024	24" X 36"	2700-3200 LUX	17.196 lbs	25.98" X 40.33" X 3.74"
UMLSCN0034	30" X 40"	2700-3200 LUX	28.660 lbs	37.99" X 44.33" X 3.74"
UMLSCN0036	36" X 48"	2700-3300 LUX	28.660 lbs	37.99" X 52.36" X 3.74"
UMLSCN0046	40" X 60"	2700-3200 LUX	47.619 lbs	41.97" X 64.33" X 3.74"

*W:Width H: Height D:Depth



POWER LED Single Sided



MAXI frame

Available in standard sizes as unassembled and also in lengths and parts as semi products.

For more info contact us!



Parts



Power Maxi Led profiles 39.37"-196.85"

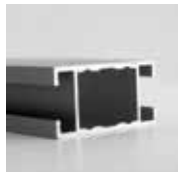

H Profiles



Red&black electrical cable 19.69"-98.43"



Connectors: UYUP412270 Square Corner Connector for Power LED, included in each box.



Power Supplies 90W-160W.



Led Modules 3-S5 LED

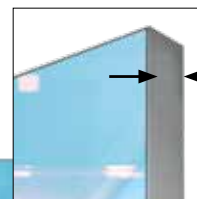

3.94" / 100 mm depth

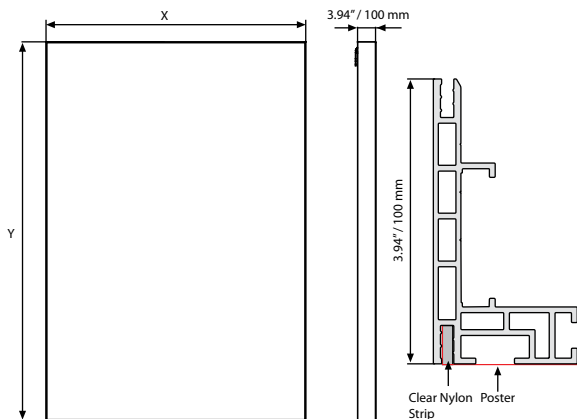

Clear nylon strip.
Please don't forget to order.

MATERIAL : Silver anodised aluminium

ARTICLE	EXTERNAL (x-y)	LIGHTING
UMPLTN4060	40" X 60"	1900-2300 LUX
UMPLTN6040	60" X 40"	1900-2300 LUX
UMPLTN8790	87" X 90"	1800-2100 LUX
UMPLTN1090	100" X 90"	2000-2300 LUX
UMPLTN1290	120" X 90"	2000-2300 LUX
UMPLTN1890	118" X 90"	2000-2300 LUX



CE/UL Patent approved.

Maxi Frame Totem with LED Double Sided



See movie at our website www.mtdisplays.com.tr



Double sided LED Maxi Totem promotes the message with high and even illumination. Pre-treated light guided panel diffuses light even and powerfully. LED illumination saves up to 60% energy costs (compared to fluorescent technology).

All units pass CE/UL PAT tests and are supplied with their quality certificates. Delivered with 8 ft. long cable and EU plug. UK and US plugs should be specified with order.

The thickness of the profile is 0.16". Supplied nylon strip is 0.12", so recommended fabric thickness for digital printing is 0.02". The pull sticker in 0.02" thickness must be sewed on the fabric for taking out the poster when fitted into the channels.

Complete with low voltage 6A powersupply. 0.51" on each side of the fabric is fitted into Maxi Profiles, so 1.02" on each Fabric Poster is not seen on the poster.

2 packs. See info chart for pack sizes.

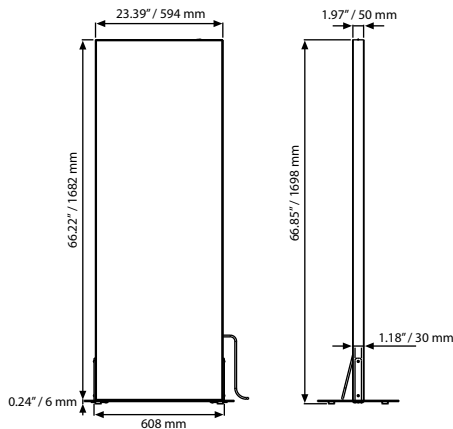
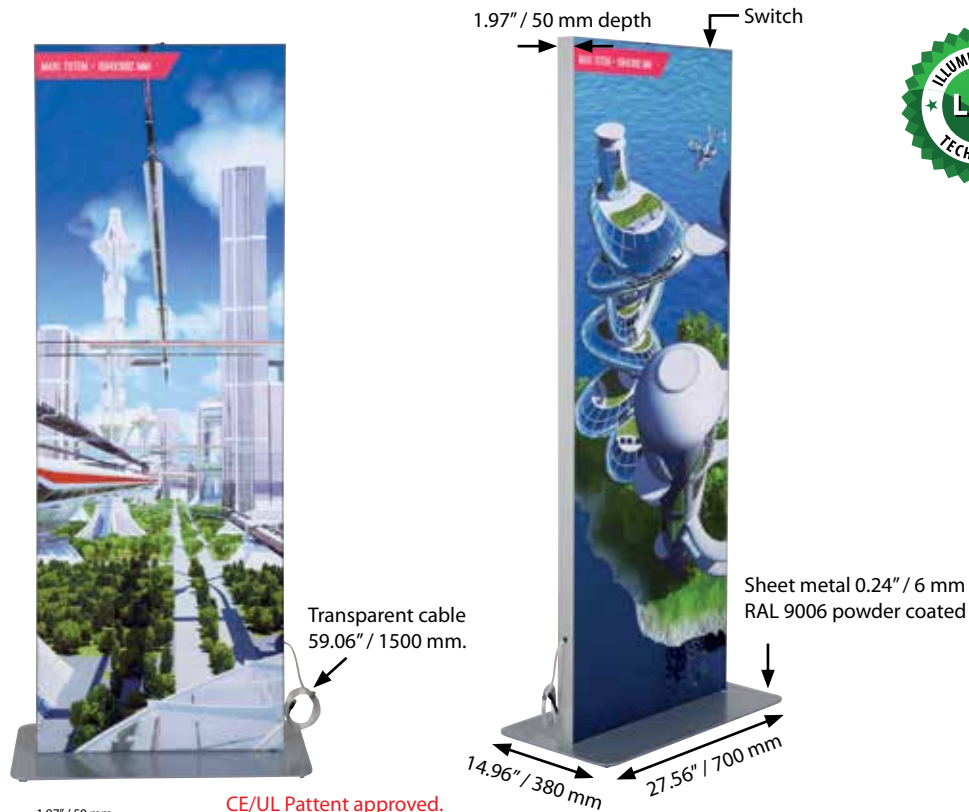

CE/UL Patent approved.

Including 7/16 power supply.

Clear nylon strip
Please don't forget to order.

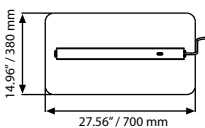

MATERIAL : Silver anodised aluminium					WEIGHT	PACKING SIZE
ARTICLE	EXTERNAL (x-y)	POSTER	COPY	LIGHTING	WITH PACKING	*W X H X D
UMTLSNO2A1	23.39"	23.39" X 66.22"	23.39" X 66.22"	2100-2600 LUX	30,864 lbs / 29,982 lbs	24.61" X 70.87" X 3.74" / 15.75" X 28.35" X 1.18"



*W:Width H: Height D: Depth

Semi Products for Maxi Frames



Profiles of Maxi Frames

Valet Profile

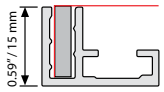

Article: UYUP014103
Single Sided MAXI profile VALET Profile Suitable for RIVER MAXI 0.59"x0.87", 9 ft.

Ace Profile

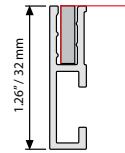

Article: UYUP014105
Single Sided MAXI profile ACE Profile Suitable for BAY MAXI 1.26"x0.31", 9 ft.

Dame Profile

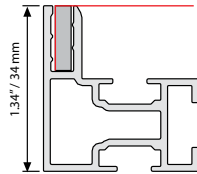

Article: UYUP014102
Single Sided MAXI profile Dame Profile Suitable for GULF MAXI and ILLUMINATED MAXI 1.34"x1.26", 9 ft.

Queen Profile

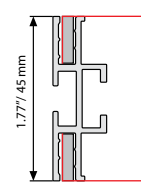

Article: UYUP014104
Double Sided MAXI profile QUEEN Profile Suitable for LAGOON MAXI 1.77"x0.59", 9 ft.

King Profile

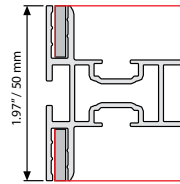

Article: UYUP014101
Double Sided MAXI profile KING Profile Suitable for OCEAN MAXI 1.97"x1.57", 9 ft.

Power LED Profile

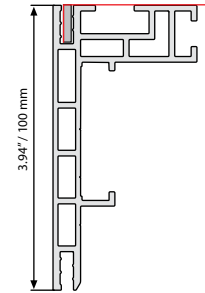

Article: UYPLPT1030
Power LED Profile. 3.94" x 1.99", 9 ft.

Wood Maxi Frame Profile

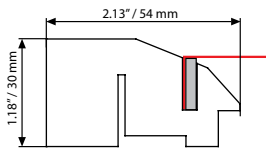

Article: UYPMFWN020
Wood Maxi profile 6 ft. Natural Wood
Article: UYPMFWD020
Wood Maxi profile 6 ft. Dark Wood

Wood Maxi Frame Corner

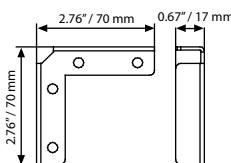

Article: UYPMFW0C00
Wood Maxi Frame corner, 4 Pcs.

H Profile

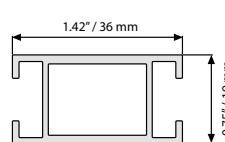

Article: UYUP014106
H Profile, 1.42"x0.75", 9 ft. Suitable for Ace, Dame, Queen and King profiles.

Components of Maxi Frames

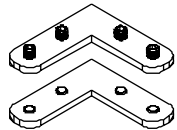

Article: UYUP412295
Corner Cleat for OCEAN & GULF. Packed by 8.



Article: UYUP412270
Square Corner Connector for BAY, LAGOON and Power LED. Packed by 10.

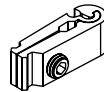

Article: UYUP412291
Straight Cleat for H profile. Packed by 8.

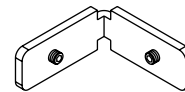

Article: UYUP412310
Straight Cleat for H profile. Packed by 8.



Article: UYUP025010
L TYPE Corner Connector for RIVER. Packed by 10.

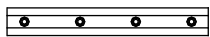

Article: UYUP412320
Flat Connector for Ocean, Gulf, Lagoon and Bay Maxi frame profile. Packed in 10.



Article: UYUP412330
Flat Connector for Gulf Maxi frame profile. Packed in 10.

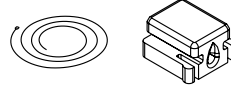

Article: UYUP460245
Hanging System including wire cable for double sided MAXI. Packed by 8.



Article: UYUP460235
Clear Nylon Strip 0.51"x0.12", 328 ft.



Article: UYUP460220
Clear Nylon Strip with tape 0.51"x0.12", 164 ft.

Feets of Maxi Frame (To be used with Double Sided King Profile)

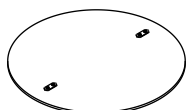

Article: UYUP412271
Circle Ø 17.72" x 0.24" single packed.

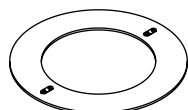

Article: UYUP412272
Hoop Ø 17.72" x 0.24" single packed.

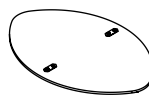

Article: UYUP412273
Baseball 17.72" x 11.81" x 0.24" single packed.



Article: UYUP412274
Fillet 19.69" x 7.09" x 0.24" single packed.

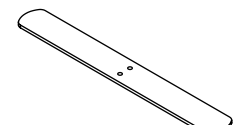

Article: UYUP412275
Flat 15.75" x 19.70" x 0.20" single packed.

Maxi Frames Rubber Strip



See movie at our website www.mtdisplays.com.tr



Nylon strip application when sew on textile

We launched the new Version 1.0 Maxi Frame rubber strip application existing in Maxi Frame Index. Through this specification development process, we will both assess new opportunities for easy and fast product assembly and the potential to mount Maxi Frames free from sew-on process in exhibitor areas and event places. We invite your participation in following the below information over the increased performance for rubber strips when combined with double sided tape.

Due to the potential expansion of Maxi Frame, which is a high quality frame system composed of stylish aluminum profiles to create a 'frameless' look, in various applications and custom printed

polyester fabric, there have been many requests for easy and sewing-free application of printing inward the profiles.

We redesigned the existing product focusing to purchase, and use of efficient components. For this purpose we concentrated on addition of double sided tape over existing rubber strip.

We defined the types of equipment to cover the new production process of rubber with correct tape and determined the appropriate means of testing the application in tension of various types and thicknesses.

We prepared the below assembly sheet and movie to better express the application and improvement over the taped rubber strip.

NEW Application with double sided tape.



Application of nylon strip by sew-on process



Application of nylon strip by double sided tape



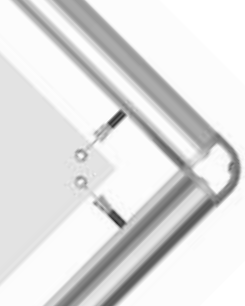

The sky is the limit
with our range of
outdoor banners!

OMNIFRAME

www.omni-frame.com

OHIM DM/084 725

Suitable for outdoor large format prints, Omni Frame is a large format Outdoor Banner System, made from lightweight aluminium. It is ideal for use with PVC eyelet banners. Omni Frame Banner System is used for large advertising areas which need to be changed regularly such as most forecourts and retail environments. It is also a great accompaniment for marquees and race events. Omni Frame is suitable for flat, large banners on buildings as well as mounting stand displays for indoor and outdoor use. The variable lengths of aluminium profile give you the ability to install banners in customised size. This banner holder is assembled quickly and easily, it is a real alternative to traditional billboards. These outdoor durable frames are permanently attached to the wall with the banner using elasticated straps. These are perfect displays for forthcoming events, special offers or sales, theatres, garden centres, retail outlets, sports halls, sporting venues, conferences, airports and public areas. Omni Frame has a smart design and all parts are robust, durable and reusable. The banner is easy to change. Customised sizes are available upon request. It is delivered parts unassembled to save from transport.

FEA TEST RESULTS OF OMNI FRAME

Omni Frame is tested for security in outdoor conditions. Conditions: Without any back rest, Omni Frame is tested against windy conditions max 22,5miles or 36km. Vinyl banner deforms and may not take previous form again based on the type and quality of material.

In case of 2-fold eyelet application, the banner keeps the form upto wind speed of 22miles. Test had been conducted with 196.85" x 393.70" Omni Frame with 0.04" vinyl banner.

Result: Omni Frame is strong and stable for harsh weather conditions. Banner may get damaged depending on the banner and application. MT Displays recommends the apply eyelets 2-fold vinyl banner for harsh weather conditions.



OHIM DM/084 725

Omni Frames



www.omni-frame.com



Fabric is the best recommended option for outdoor advertising. It shines with its light weight and durability among other alternatives such as PVC, Vinyl & Polyethylene. The advantages also include ease of application and compatibility with its stand. The plastic buttons are easily inserted into the channel on Omni Frame profiles. For renewal of the banner, the frame does not have to be unmounted. Poster can only be replaced by taking of the elastic hook.

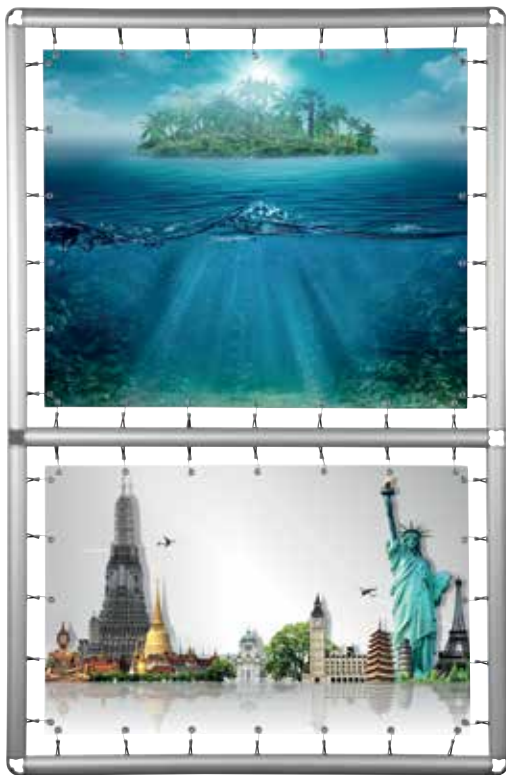

OHIM DM/084 725

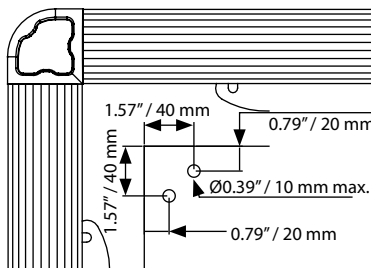
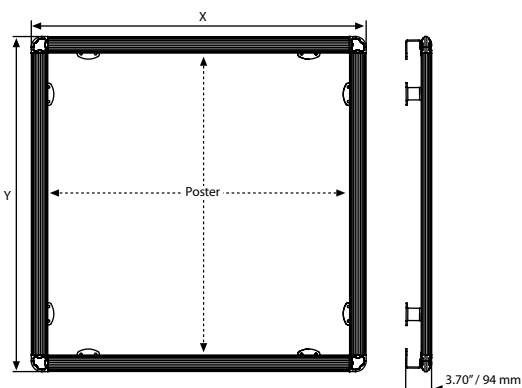

The first eyelet should be placed on the corners 1.57" from the edges of poster used for Omni Frame. Please see below basic drawing. The other eyelets can be applied spacing 5.91"-11.81" from the first eyelet depending on the environment to be used.



Omni Frames



www.omni-frame.com

4 different application options

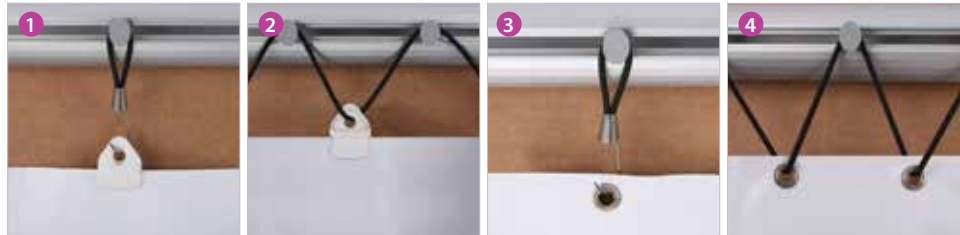

Omni Frame is a flexible outdoor display system with excellent durability to make combinations via several units for greater visual impact. Limited number of parts, offers solutions for any size request.



Wall fixing screws of Omni Frame are included in the pack which are CE certified multi-expansion long plugs. Special anti-corrosion coated screw is made of zinc coated steel and plastic sleeve made of high quality of nylon. It is confirmed for outdoor fixing on various exterior building surfaces such as concrete, solid or honeycomb brick, hollow dense or hollow light aggregate block, aerated concrete and solid stone.



UYPOM02000
Corner bracket
(Packed by 4 pcs), Ral 9006



UYPOM03000
T Connector
(Packed by 2 pcs), Ral 9006



UYPOM06000
Profile connector
(Packed by 2 pcs), Ral 9006



UYPOM04000
Wall fixing
(Packed by 4 pcs), including screw set.



UYPOM05000
Plastic buttons
(Packed by 20 pcs)



TMC4010500
Clamp for banner, White
(Packed by 40 pcs)



TSH4010501
Black bungee cord with stainless steel hook
(Packed by 40 pcs)



UYPOM07000
Elastic strap (164 ft)



Aluminium profile, silver anodised.

Presentation Box / UYPOM00010



OMNI FRAME PROFILE		WEIGHT	PACKING SIZE
ARTICLE	LENGHT	WITH PACKING	*W X H X D
UYPOM00042	42"	2.821 lbs	9.84" X 11.81" X 2.95"
UYPOM00062	62"	3.791 lbs	9.84" X 11.81" X 3.54"
UYPOM00082	82"	4.872 lbs	9.84" X 11.81" X 3.54"
UYPOM00122	122"	7.253 lbs	9.84" X 11.81" X 3.94"
UYPOM00140	140"	8.708 lbs	9.84" X 11.81" X 3.94"
UYPOM00182	182"	11.530 lbs	9.84" X 11.81" X 4.72"
UYPOM00200	200"	12.456 lbs	9.84" X 11.81" X 5.51"

OMNI FRAME: Silver anodised aluminium			WEIGHT	PACKING SIZE
ARTICLE	EXTERNAL (x-y)	POSTER SIZE	WITH PACKING	*W X H X D
UOMN001296	128.70" X 104.69"	120" X 96"	44.312 lbs	11.81" X 102.36" X 2.76"
UOMN001284	128.70" X 92.70"	120" X 84"	42.549 lbs	11.81" X 90.55" X 2.76"
UOMN009684	104.69" X 92.70"	96" X 84"	37.699 lbs	7.87" X 102.36" X 2.76"
UOMN001212	128.70" X 128.70"	120" X 120"	49.383 lbs	7.87" X 63.78" X 5.51"



Insert and fix with screw.



Corner bracket made of aluminium injection metallic silver powder coated.



Insert banner buttons into the rear channel of the profile.

OMNI FRAME SEMI PRODUCTS		WEIGHT	PACKING SIZE
ARTICLE	DESCRIPTION	WITH PACKING	*W X H X D
UYPOM02000	Corner Bracket (Packed by 4 pcs), Ral 9006	3.968 lbs	3.74" X 9.45" X 6.50"
UYPOM03000	T Connector (Packed by 2 pcs), Ral 9006	1.984 lbs	3.74" X 9.45" X 6.50"
UYPOM04000	Wall Fixing (Packed by 4 pcs), including screw set	4.409 lbs	3.74" X 5.91" X 3.94"
UYPOM05000	Plastic Buttons (Packed by 20 pcs)	0.044 lbs	
UYPOM06000	Profile Connector (Packed by 2 pcs), Ral 9006	0.881 lbs	3.35" X 10.63" X 3.54"
TMC4010500	Clamp For Banner, White (Packed by 40 pcs)	1.146 lbs	
TSH4010501	Black Bungee Cord with Stainless Steel Hook (Packed by 40 pcs)	0.925 lbs	
UYPOM07000	Elastic Strap (164 ft)	0.220 lbs	

*W:Width H: Height D: Depth



Omni A Boards



www.omni-frame.com



Constructed aluminium, Omni A Board is a double sided, heavy outdoor banner system. It is ideal for use with PVC eyelet banners. Omni A Board is used for large advertising areas that the banner needs to be changed regularly or carried to different places. It is a great accompaniment for outdoor events, marquees and race. Omni Frame withstands approximately 42-50kph wind.

- Shipped unassembled.
- Banner and eyelets not included.
- Plastic buttons and elastic hooks included enough for each size.
- 2 packs. See info chart for pack sizes.

Perfect outdoor use.

- Ease of transport, quick&easy installation.
- Flexible outdoor display with excellent durability.



OHIM DM/084 725



Cary bag

BAG: Black

ARTICLE	SIZE
UYPOM00010	10.43" X 104.33" X 8.07"
UYPOM00020	10.43" X 64.17" X 8.07"

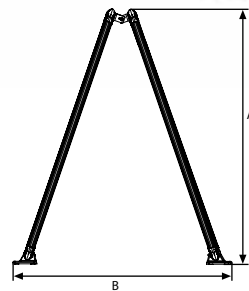
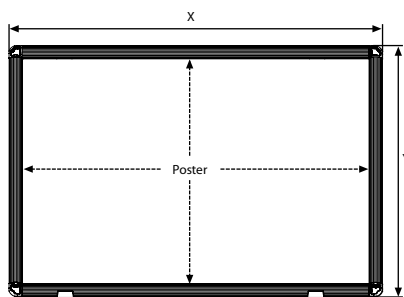

2.645 lbs. Each feet.
Feet optional accessories.

OMNI A BOARD FEET / HINGE

ARTICLE	DESCRIPTION
UYPOM09000	Feet for Omni Aboard, 4pcs per pack
UYPOM10000	Hinge for Omni Aboard, 2pcs per pack

OMNI FRAME: Silver anodised aluminium				WEIGHT	PACKING SIZE	
ARTICLE	EXTERNAL (x-y)	POSTER SIZE	A	B	WITH PACKING	*W X H X D
UAOMN04059	48.70" X 67.70"	40" X 59"	65.35"	48.82"	43.210 lbs	10.43" X 64.57" X 3.54" / 13.39" X 19.29" X 5.31"
UAOMN04098	48.70" X 106.70"	40" X 98"	94.49"	64.57"	52.910 lbs	10.83" X 104.33" X 3.54" / 13.39" X 19.29" X 5.31"
UAOMN04918	49.83" X 126.70"	49" X 118"	113.98"	70.87"	62.390 lbs	10.83" X 62.99" X 5.71" / 13.39" X 19.69" X 7.68"

*W:Width H: Height D: Depth





Sign Holders

- Poster Stands
- Oval Based Floor Poster Stands
- Eco Floor Poster Stands
- Novel Display Stands **NEW**
- Display Stands
- Display Stand Banner Sets
- Display Stand Slide-in Frames
- Poster Display Convex Boxes
- Totems
- Decorative Totems
- Mono Totems
- LEDA Illuminated Magnetic Totems



Poster Stand



Single Sided / Double Sided
Single faced acrylic shelves and wheels can be added to the info boards. An anti-reflex PET cover is presented in each unit. 1.25" profile snap frame is used.

The product is packed unassembled with an easy to understand instruction sheet & fixing hardware.

Wheels can be ordered optionally.

Acrylic shelves should be ordered separately.

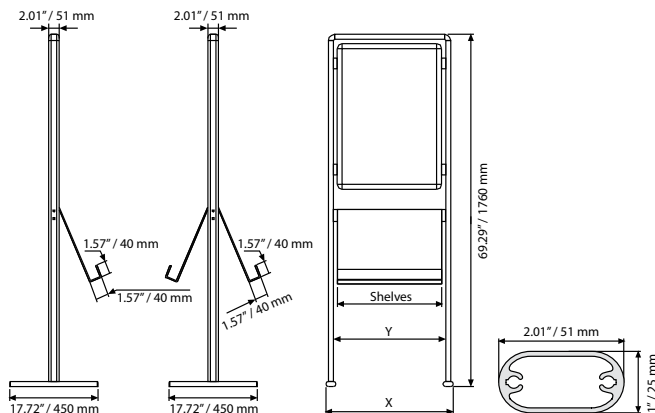

SINGLE SIDED : Silver anodized aluminum					WEIGHT	PACKING SIZE	Shelves : 4 mm acrylic	
ARTICLE	POSTER	X	Y	WITH PACKING	*W X H X D	SINGLE SIDED	MAX. CAPACITY	
UIB200TN18	18" X 24"	24.33"	27.32"	17.636 lbs	24.41" X 68.90" X 2.56"	UYRT0002A4	2 X (8.5"X11")	
UIB200TN22	22" X 28"	28.35"	31.34"	20.943 lbs	28.35" X 69.29" X 2.36"	UYRT0003A4	3 X (8.5"X11")	
DOUBLE SIDED : Silver anodized aluminum					WEIGHT	PACKING SIZE	Shelves : 4 mm acrylic	
ARTICLE	POSTER	X	Y	WITH PACKING	*W X H X D	DOUBLE SIDED	MAX. CAPACITY	
UIB200CN18	18" X 24"	24.33"	27.32"	20.943 lbs	24.41" X 68.90" X 2.56"	UYRC0002A4	4 X (8.5"X11")	
UIB200CN22	22" X 28"	28.35"	31.34"	22.928 lbs	28.35" X 69.29" X 2.36"	UYRC0003A4	6 X (8.5"X11")	

* W:Width H: Height D: Depth



Oval Based Floor Poster Stands



Oval Info board is a double-sided economy floor stand. The black PVC in the middle of 2 posters prevents light transmission.

The product is packed unassembled with an easy to understand instruction sheet & fixing hardware.

Delivered with poster protective set that includes 2 clear + 1 black sheet.

Heavy base provides stability.

2 packs. See info chart for pack sizes.

Color options



Silver Black

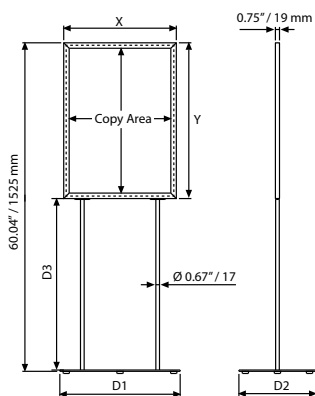
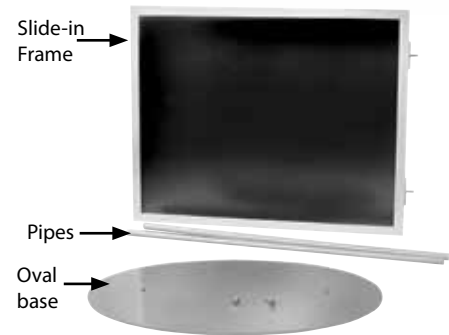

MATERIAL : Silver & black anodized aluminum								WEIGHT	PACKING SIZE
ARTICLE	COLOUR	EXTERNAL (x-y)	POSTER	COPY	D1	D2	D3	WITH PACKING	*W X H X D
UIBS10N022	Silver	22.91" X 28.91"	22" X 28"	20.90" X 26.90"	22.05"	14.09"	30.71"	28.108 lbs	23.62" X 29.53" X 0.79" / 14.96" X 22.64" X 1.18"
UIBS10N024	Silver	24.91" X 36.91"	24" X 36"	22.90" X 34.90"	22.05"	14.09"	25.59"	29.762 lbs	25.20" X 37.01" X 0.79" / 14.96" X 22.64" X 1.18"
UIBS10B022	Black	22.91" X 28.91"	22" X 28"	20.90" X 26.90"	22.05"	14.09"	30.71"	28.086 lbs	23.62" X 29.53" X 0.79" / 14.96" X 22.64" X 1.18"
UIBS10B024	Black	24.91" X 36.91"	24" X 36"	22.90" X 34.90"	22.05"	14.09"	25.59"	29.762 lbs	25.20" X 37.01" X 0.79" / 14.96" X 22.64" X 1.18"

*W:Width H: Height D: Depth



Eco Floor Poster Stands



See movie at our website www.mtdisplays.com.tr



Eco Info board is a new double-sided economy floor stand. The black PVC in the middle of 2 posters prevents light transmission. Easy to change poster by simply sliding it in through the channels of the stand. Eco Info board has different models that can go up to 2 or 3 tier and display max. 6 posters at once. It is suitable for public spaces. The square base provides stability.

The product is packed unassembled with an easy to understand instruction sheet & fixing hardware.

Delivered with poster protective set that includes 2 clear + 1 black sheet.

Color options



Silver Black



1 Tier - Black



2 Tier - Silver



19.69" X 66.93" (500 X 1700 mm)

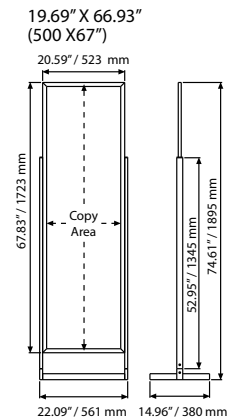

MATERIAL : Silver & black aluminum				WEIGHT	PACKING SIZE
ARTICLE	POSTER	COPY	MODEL	WITH PACKING	*W X H X D
UIBS20N129	22" X 69"	20.91" X 67.91"	Silver anodized	24.691 lbs	26.38" X 80.12" X 3.35"
UIBS20C129	22" X 69"	20.91" X 67.91"	Black powder coated	24.691 lbs	26.38" X 80.12" X 3.35"

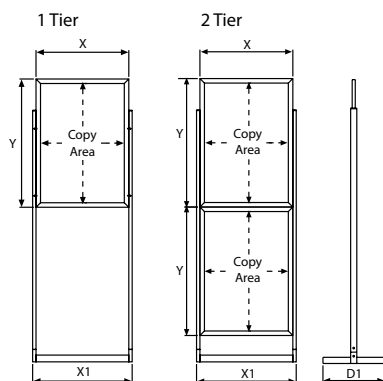

MATERIAL : Silver & black aluminum								WEIGHT	PACKING SIZE
ARTICLE	DESCRIPTION	POSTER	COPY	X	X1	Y	D1	WITH PACKING	*W X H X D
UIBS20N118	1 Tier - Silver	18" X 24"	16.93" X 22.91"	18.94"	20.47"	24.92"	14.96"	14.175 lbs	23.43" X 69.29" X 3.35"
UIBS20N122	1 Tier - Silver	22" X 28"	20.91" X 26.93"	22.91"	24.45"	28.94"	14.96"	16.203 lbs	27.36" X 65.75" X 3.35"
UIBS20N124	1 Tier - Silver	24" X 36"	22.91" X 34.92"	24.92"	26.46"	36.93"	14.96"	16.975 lbs	29.53" X 69.29" X 3.35"
UIBS20B118	1 Tier - Black	18" X 24"	16.93" X 22.91"	18.94"	20.47"	24.92"	14.96"	14.219 lbs	23.43" X 69.29" X 3.35"
UIBS20B122	1 Tier - Black	22" X 28"	20.91" X 26.93"	22.91"	24.45"	28.94"	14.96"	16.203 lbs	27.36" X 65.75" X 3.35"
UIBS20B124	1 Tier - Black	24" X 36"	22.91" X 34.92"	24.92"	26.46"	36.93"	14.96"	16.975 lbs	29.53" X 69.29" X 3.35"
UIBS20N218	2 Tier - Silver	18" X 24"	16.93" X 22.91"	18.94"	20.47"	24.92"	17.72"	18.210 lbs	23.43" X 73.43" X 3.35"
UIBS20N222	2 Tier - Silver	22" X 28"	20.91" X 26.93"	22.91"	24.45"	28.94"	17.72"	21.715 lbs	27.36" X 65.75" X 3.35"
UIBS20N224	2 Tier - Silver	24" X 36"	22.91" X 34.92"	24.92"	26.46"	36.93"	17.72"	23.589 lbs	27.17" X 76.57" X 3.35"
UIBS20B218	2 Tier - Black	18" X 24"	16.93" X 22.91"	18.94"	20.47"	24.92"	17.72"	18.210 lbs	23.43" X 73.43" X 3.35"
UIBS20B222	2 Tier - Black	22" X 28"	20.91" X 26.93"	22.91"	24.45"	28.94"	17.72"	21.715 lbs	27.36" X 65.75" X 3.35"
UIBS20B224	2 Tier - Black	24" X 36"	22.91" X 34.92"	24.92"	26.46"	36.93"	17.72"	23.589 lbs	27.17" X 76.57" X 3.35"

* W:Width H: Height D: Depth



Novel Display Stand



See movie at our website www.mtdisplays.com.tr



New to our range, this robust, silver anodised Novel Free Standing brochure and sign system allows designing various styles to suit different environment. 4-channel profile holds accessories to make single sided or double sided display system.

- Product is packed unassembled with an easy-to understand instruction sheet & fixing set.
- Make up your own stand in your desired variation. Heavy & stable base for public spaces.
- Please order the accessories separately.
- 2 packs. See info chart for pack sizes.
- Assembled in 40 seconds

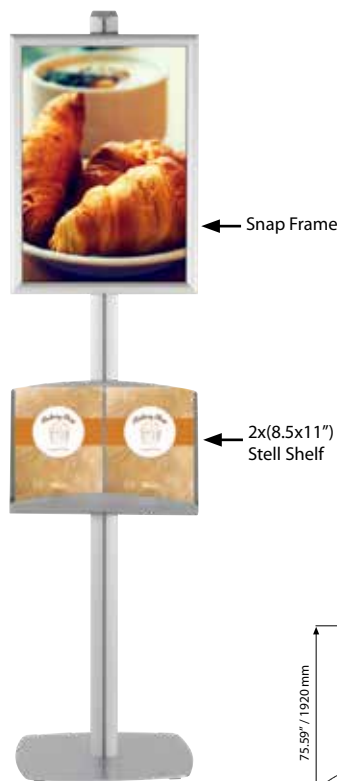
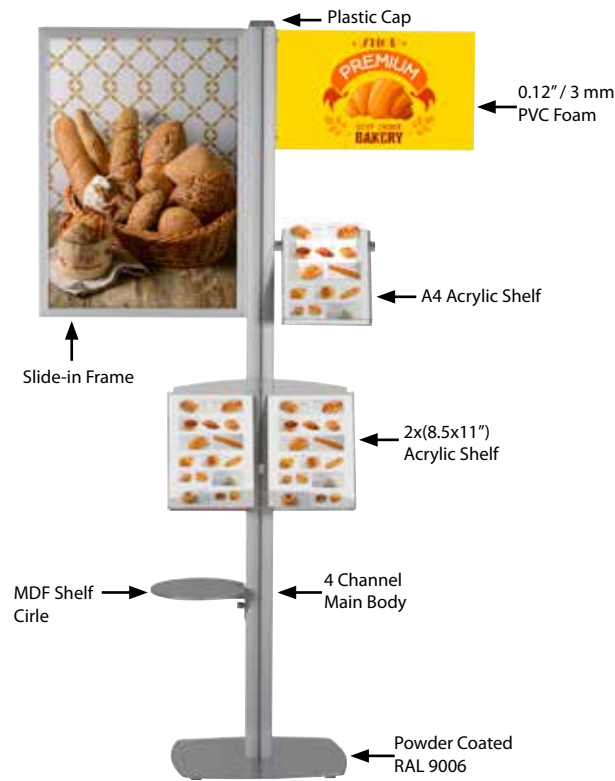

Some possible variations using 4 channel profile

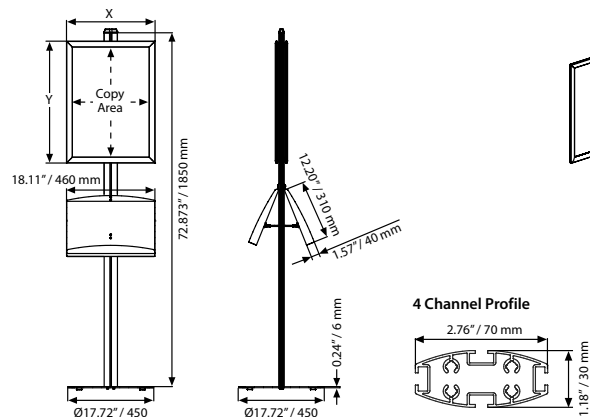
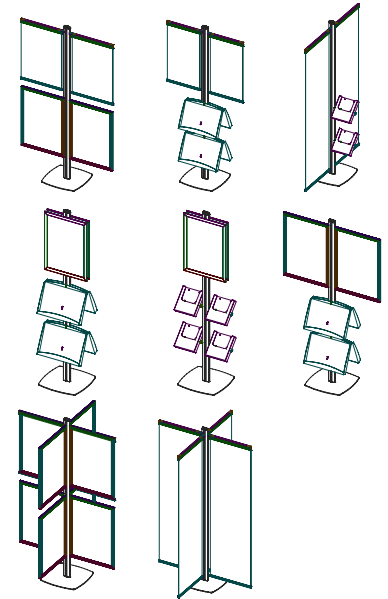

SNAP FRAME: 1\"/>							
MITRED	ROUND	DESCRIPTION	EXTERNAL (x-y)	POSTER	COPY	WEIGHT WITH PACKING	PACKING SIZE *W X H X D
UFSL000081	UFSL010081	Silver	9.69\"/>				

MAINBODY WITH 4 CHANNEL: Powder coated in RAL 9006			
ARTICLE	DESCRIPTION	WEIGHT WITH PACKING	PACKING SIZE *W X H X D
UFSL001200	Main body pole	5.291 lbs	3.35\"/>



*W:Width H: Height D: Depth

Display Stand



2 Channel

An ideal brochure stand that permits an indoor use of different models. The fixing grooves on both sides of the central pole hold single-sided or double-sided frames and shelves separately or collectively at the same time. The frames are recommended for use in 1.1" profiles in both portrait or landscape position. The powder coated steel shelves are 0.05" thick, and the clear acrylic shelves are 0.16" thick.

- The product is packed unassembled with an easy to understand instruction sheet & fixing hardware.
- Make up your own stand in your desired variation. Heavy & stable base for public spaces.
- 2 packs. See info chart for pack sizes.



Some possible variation.

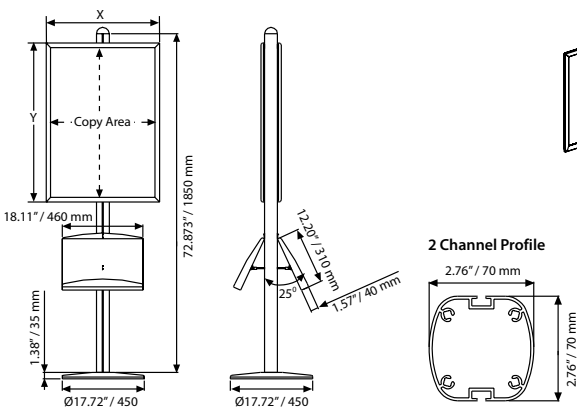
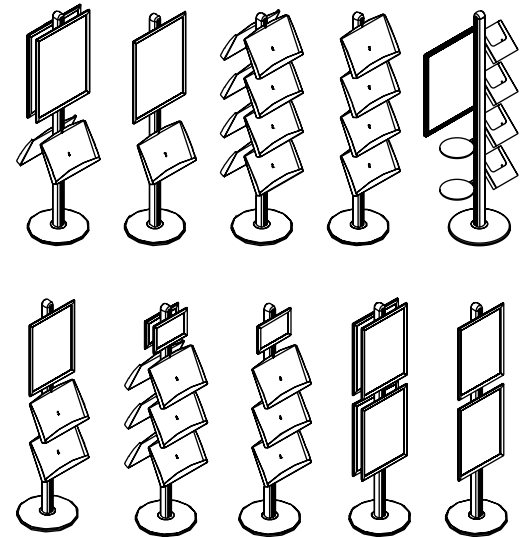

MAINBODY WITH 2 CHANNEL: Powder coated in RAL 9006			
ARTICLE	DESCRIPTION	WEIGHT	PACKING SIZE
		WITH PACKING	*W X H X D
UFSL001000	Main body pole	7.605 lbs	3.15" X 76.7" X 3.15"
	Main body base	19.731 lbs	19.29" X 19.29" X 1.97"

SNAP FRAME: 1" / 45° - Round						WEIGHT	PACKING SIZE
MITRED	ROUND	DESCRIPTION	EXTERNAL (x-y)	POSTER	COPY	WITH PACKING	*W X H X D
UFSL000081	UFSL010081	Silver	9.69" X 12.17"	8.5" X 11"	7.80" X 10.28"	1.102 lbs	10.63" X 12.20" X 0.83"
UFSL000017	UFSL010017	Silver	12.17" X 18.19"	11" X 17"	10.28" X 16.30"	1.873 lbs	12.99" X 18.90" X 0.83"
UFSL000014	UFSL010014	Silver	15.20" X 23.19"	14" X 22"	13.31" X 21.30"	2.711 lbs	16.54" X 24.41" X 0.83"
UFSL000018	UFSL010018	Silver	19.21" X 25.50"	18" X 24"	17.32" X 23.31"	2.645 lbs	20.08" X 25.98" X 0.83"
UFSL000022	UFSL010022	Silver	23.19" X 29.17"	22" X 28"	21.30" X 27.28"	3.637 lbs	24.02" X 30.31" X 0.83"
UFSLB00081	UFSL01B081	Black	9.69" X 12.17"	8.5" X 11"	7.80" X 10.28"	1.102 lbs	10.63" X 12.20" X 0.83"
UFSLB00017	UFSL01B017	Black	12.17" X 18.19"	11" X 17"	10.28" X 16.30"	1.873 lbs	12.99" X 18.90" X 0.83"
UFSLB00014	UFSL01B014	Black	15.20" X 23.19"	14" X 22"	13.31" X 21.30"	2.711 lbs	16.54" X 24.41" X 0.83"
UFSLB00018	UFSL01B018	Black	19.21" X 25.50"	18" X 24"	17.32" X 23.31"	2.645 lbs	20.08" X 25.98" X 0.83"
UFSLB00022	UFSL01B022	Black	23.19" X 29.17"	22" X 28"	21.30" X 27.28"	3.637 lbs	24.02" X 30.31" X 0.83"



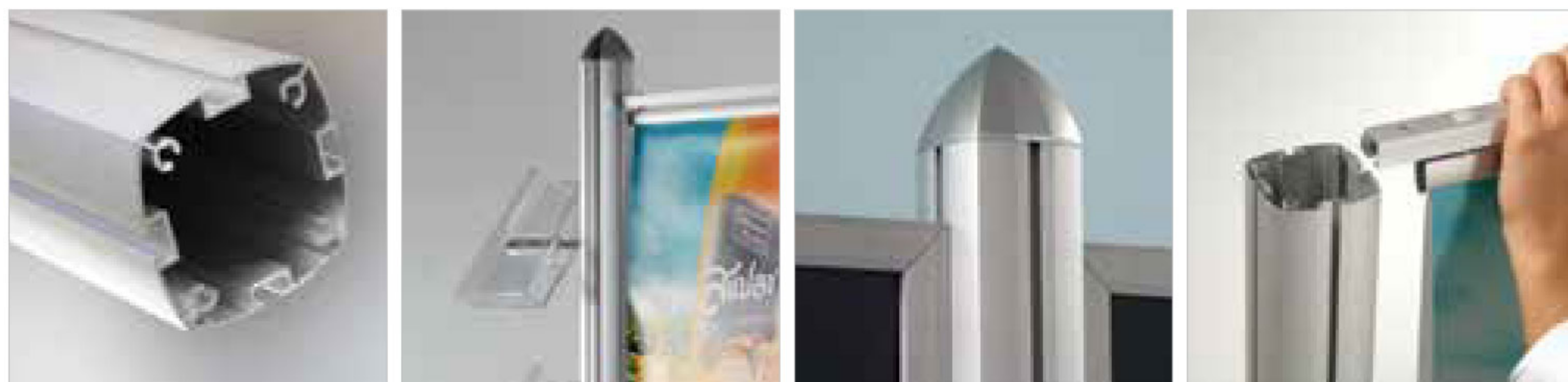

*W:Width H: Height D: Depth

Display Stands



4 Channel

An ideal brochure stand for indoor use with different options. The fixing grooves on four sides of the central pole hold single-sided or double-sided frames and shelves separately or collectively at the same time. The frames are recommended in 1.1" profiles to be used in both portrait or landscape positions. The powder coated steel shelves are 0.05" thick and the clear acrylic shelves are 0.16". Each Shelves has a 2 x 8.5" X 11" capacity. Silver anodized and Black colors available.

-  Product is packed unassembled with an easy to understand instruction sheet & fixing set.
-  Make up your own stand in your desired variation. Heavy & stable base for public spaces.
-  2 packs. See info chart for pack sizes.



Some possible variation.

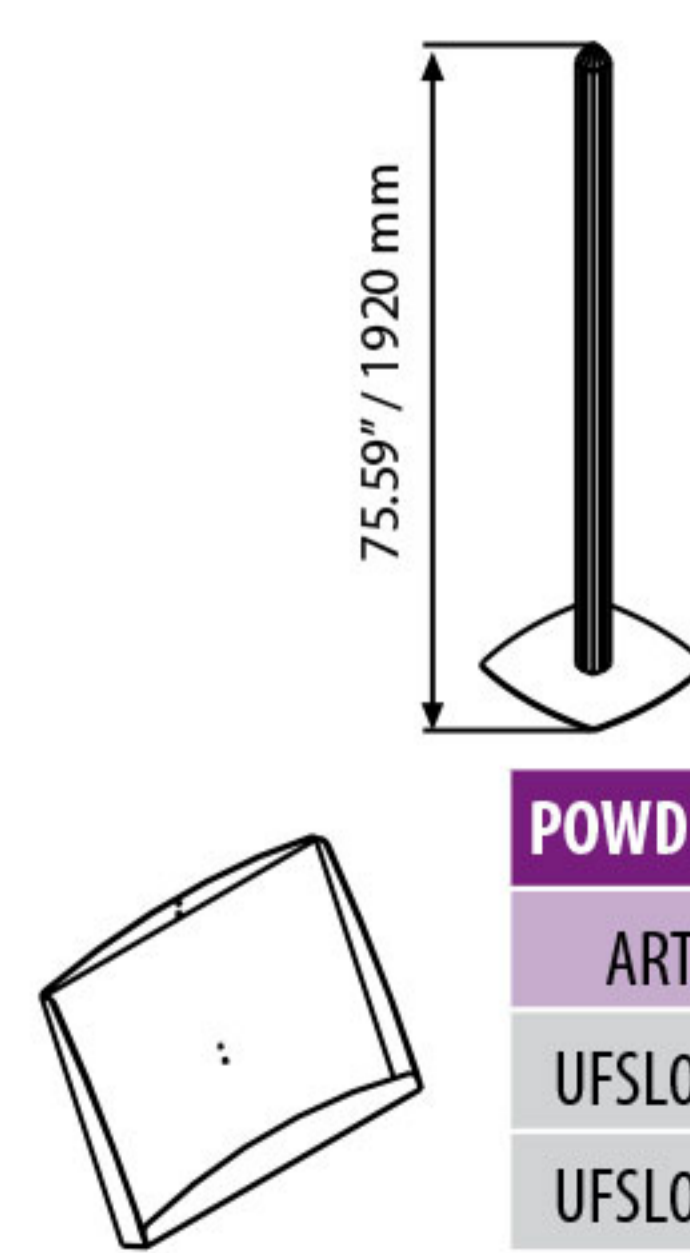
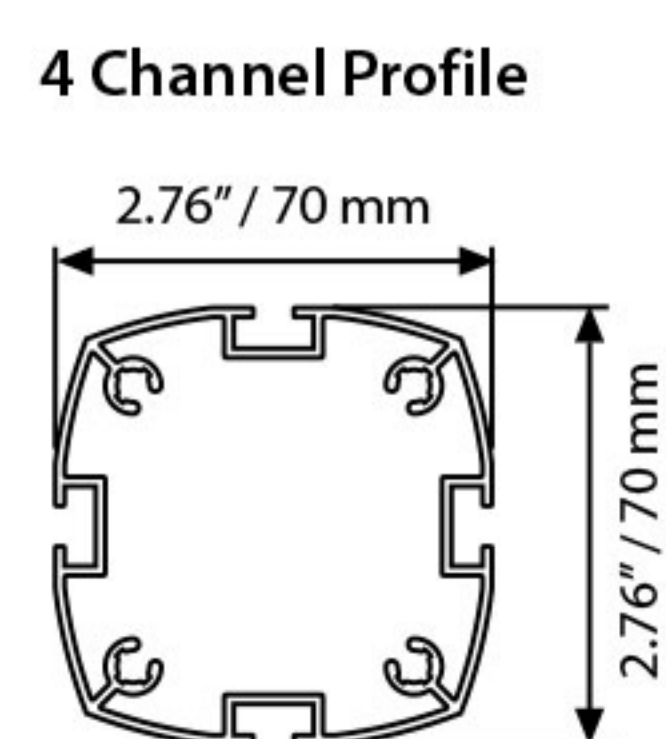
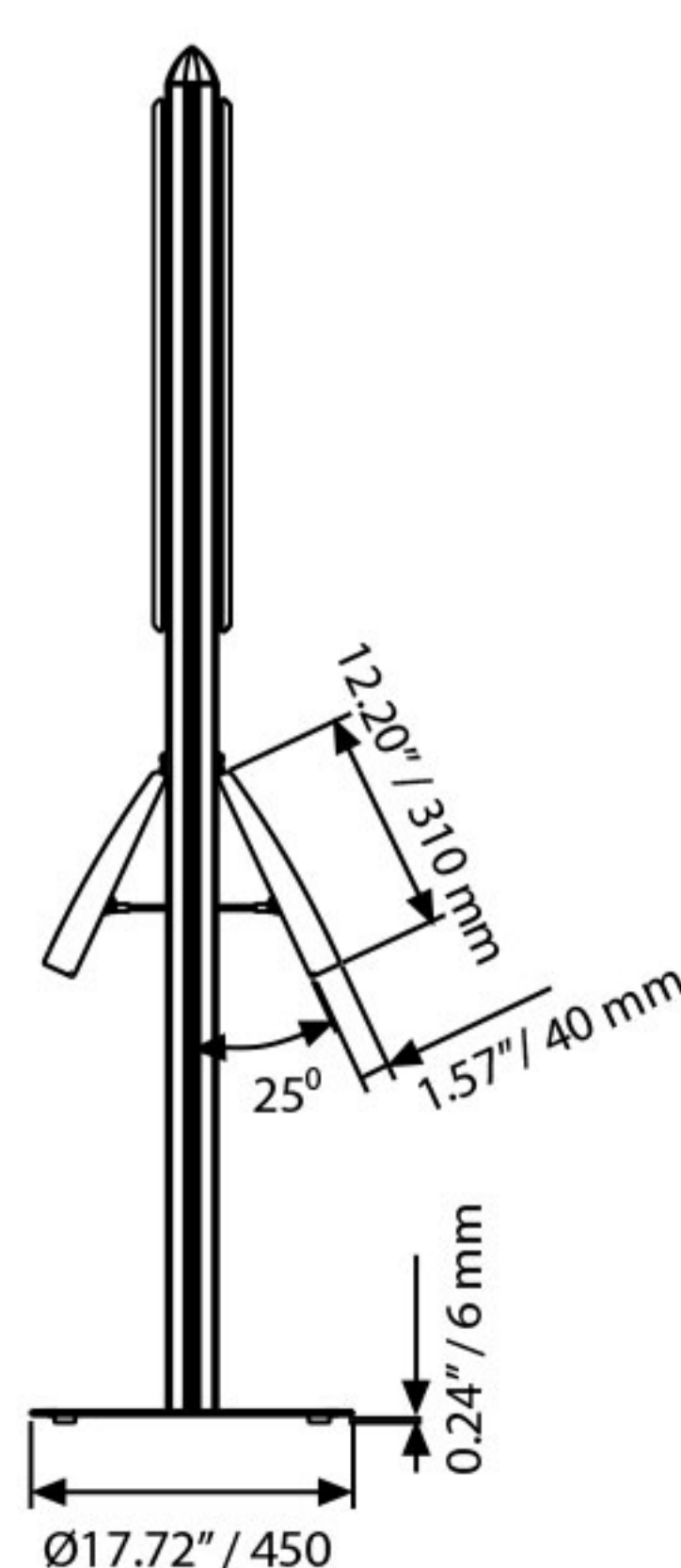
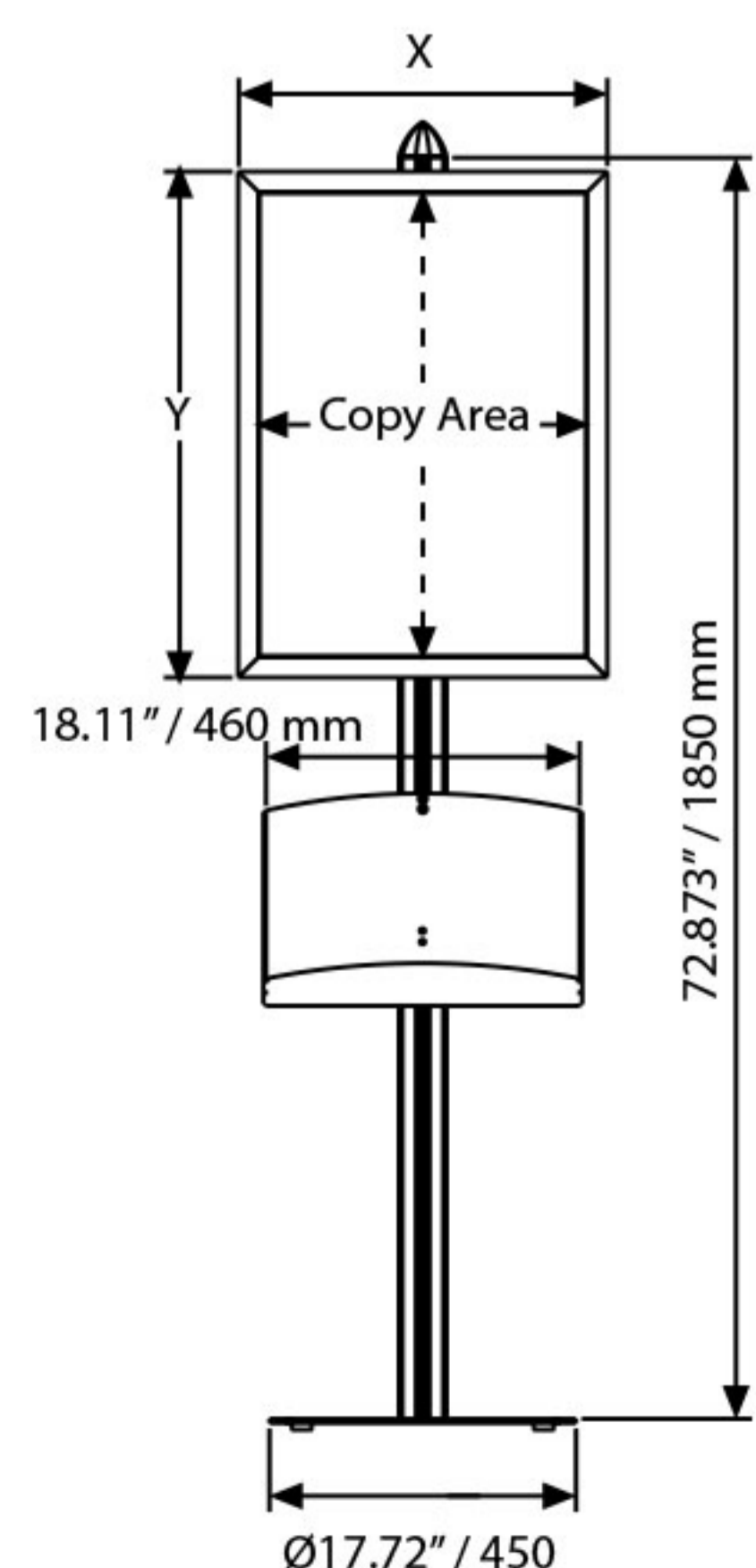
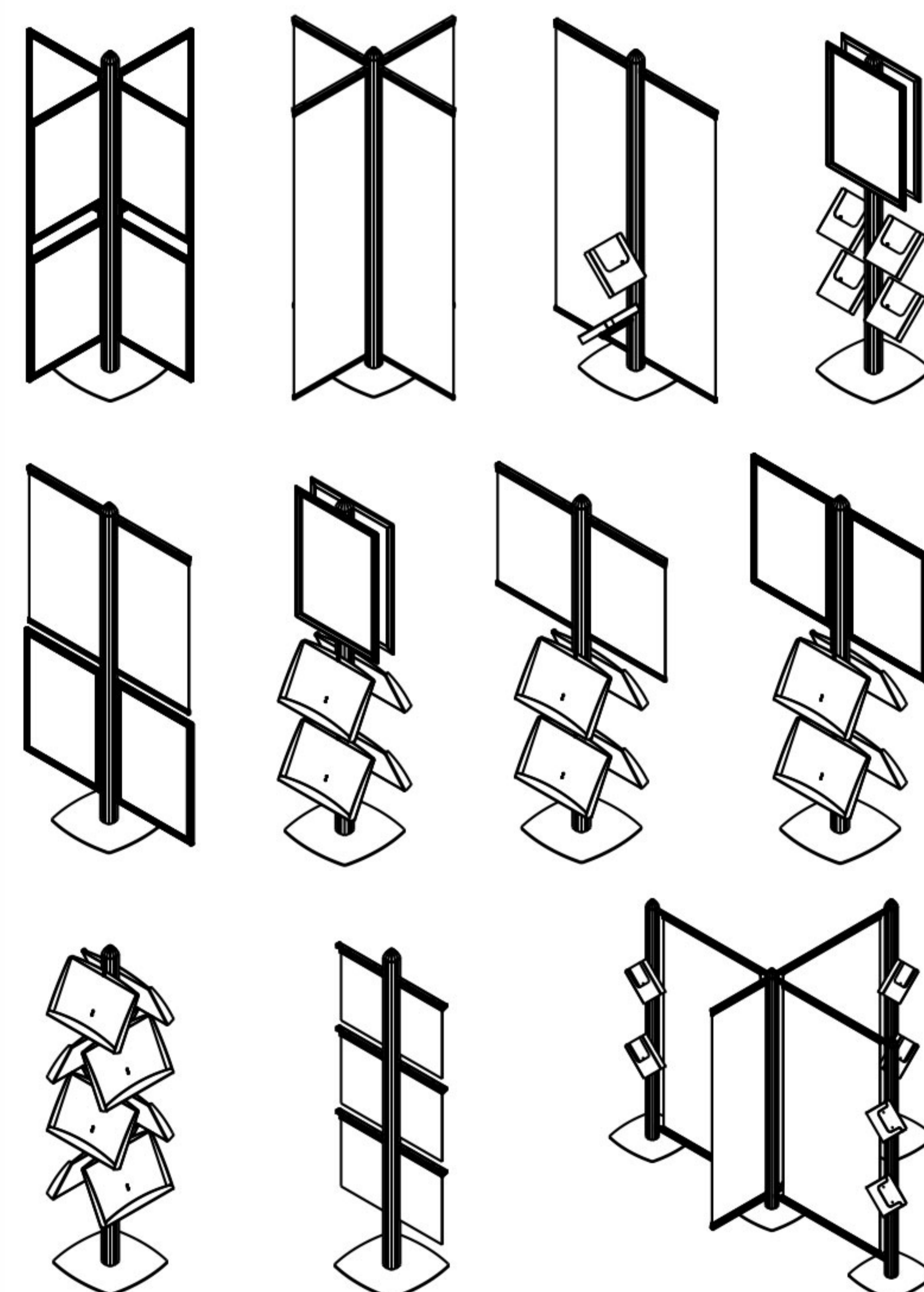

MAINBODY WITH 4 CHANNEL: Powder coated in RAL 9006			
ARTICLE	DESCRIPTION	WEIGHT WITH PACKING	PACKING SIZE *W X H X D
UFSL001100	Main body pole	7.605 lbs	3.15" X 76.7" X 3.15"
	Main body base	19.731 lbs	19.29" X 19.29" X 1.97"

POWDER COATED STEEL&ACRYLIC Shelves		WEIGHT WITH PACKING	PACKING SIZE *W X H X D
ARTICLE	CAPACITY		
UFSL002000	2 X 8.5" X 11" steel Shelves	3.968 lbs	14.17" X 18.50" X 2.36"
UFSL003000	2 X 8.5" X 11" acrylic Shelves	3.086 lbs	14.17" X 18.50" X 2.36"

*W:Width H:Height D:Depth



Display Stand Shelves



An ideal brochure stand that allows for various different models for indoor use. Grey and Black color available.



Shelves options: 1. model

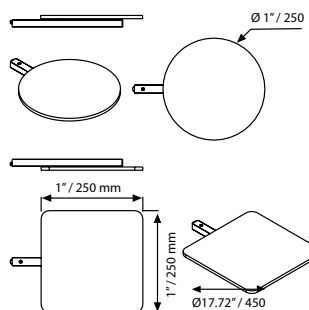

Shelves options: 2. model

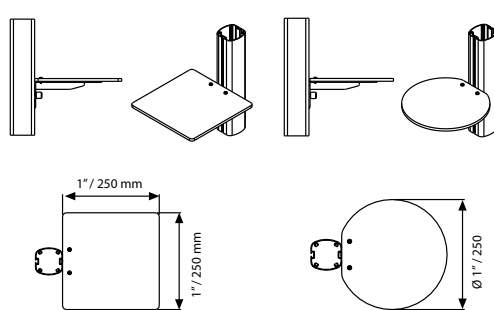

Shelves OPTIONS 1: 0.31" MDF			WEIGHT	PACKING SIZE
ARTICLE	MODEL	WEIGHT CAPACITY	WITH PACKING	*W X H X D
UFSL002500	Circle	max. 2.204 lbs	1.344 lbs	10.24" X 13.78" X 1.38"
UFSL002510	Square	max. 2.204 lbs	1.554 lbs	10.24" X 13.78" X 1.38"
Shelves OPTIONS 2: 0.31" MDF			WEIGHT	PACKING SIZE
ARTICLE	MODEL	WEIGHT CAPACITY	WITH PACKING	*W X H X D
UFSL002550	Circle	max. 11.023 lbs	1.829 lbs	10.63" X 11.22" X 4.13"
UFSL002560	Square	max. 11.023 lbs	2.226 lbs	10.63" X 11.22" X 4.13"



*W:Width H:Height D:Depth



Display Stand Banner Sets



An ideal brochure stand that enables indoor use of different models. Silver anodized and Black colors available.

-  Product is packed unassembled with an easy to understand instruction sheet & fixing hardware.
-  Make up your own stand in your desired variation. Heavy & stable base for public spaces.
-  Banner width is recommended minimum 15.7" max 27.5". Banner height is adjustable up to 66.93".

Novel Free Standing 4 channel model



Free Standing 4 channel model



Free Standing 2 channel model

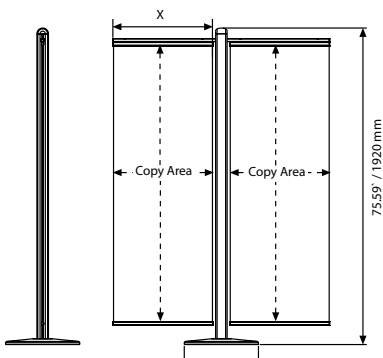

MATERIAL : Silver anodized aluminum				WEIGHT	PACKING SIZE
SILVER	BLACK	EXTERNAL (x)	POSTER	WITH PACKING	*W X H X D
UFSL110011	UFSL11B011	11"	11"	11.904 lbs	9.06" X 13.39" X 5.51"
UFSL110014	UFSL11B014	14"	14"	12.897 lbs	17.32" X 9.06" X 5.51"
UFSL110018	UFSL11B018	18"	18"	17.504 lbs	9.06" X 21.26" X 5.51"
UFSL110022	UFSL11B022	22"	22"	20.282 lbs	9.06" X 25.20" X 5.51"



*W:Width H: Height D: Depth

Display Stand Slide-in Frames



See movie at our website www.mtdisplays.com.tr

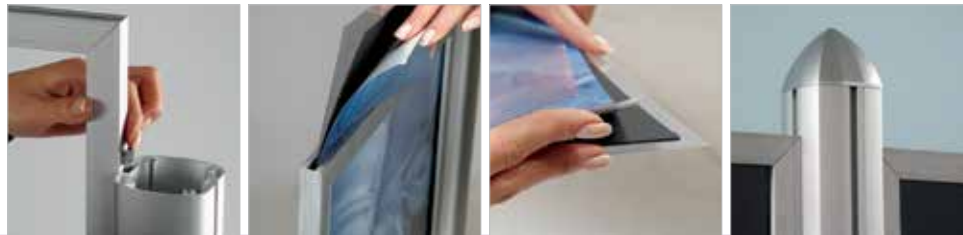

An ideal brochure stand that allows for various different models for indoor use.



Product is packed unasssembled with an easy mounting instruction sheet & fixing hardware.



Allows for multiple variations Heavy & stable base for public spaces.

Novel Free Standing
4 channel model



Free Standing
4 channel model



Free Standing
2 channel model

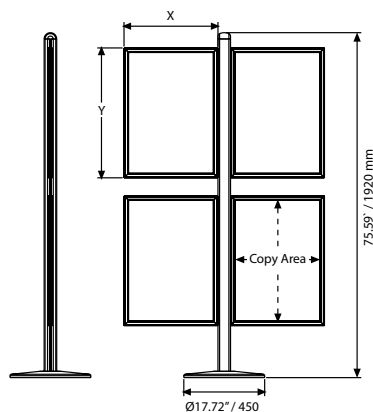
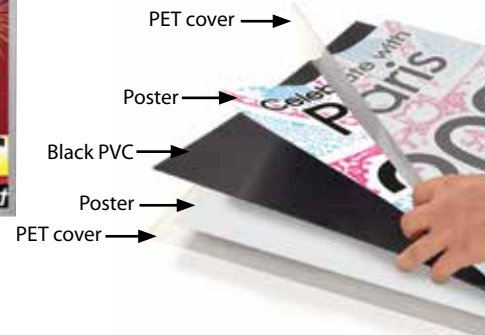

MATERIAL : Silver anodized aluminum					WEIGHT	PACKING SIZE
BLACK	SILVER	EXTERNAL (x-y)	POSTER	COPY	WITH PACKING	*W X H X D
UFSL13B081	UFSL130081	9.41" X 11.91"	8.5" X 11"	7.44" X 9.94"	1.7 lbs	9.4" X 13" X 1"
UFSL13B017	UFSL130017	11.91" X 17.91"	11" X 17"	9.94" X 15.94"	2.6 lbs	13" X 17.7" X 1"
UFSL13B014	UFSL130014	14.91" X 22.91"	14" X 22"	12.94" X 20.94"	4 lbs	17.7" X 24.8" X 1"
UFSL13BD18	UFSL130D18	18.91" X 24.91"	18" X 24"	16.94" X 22.94"	6 lbs	21.2" X 31.5" X 1"
UFSL13B700	UFSL130700	22.91" X 28.91"	22" X 28"	20.94" X 26.94"	6.2lbs	21.2" X 28.8" X 1"



*W:Width H: Height D: Depth

Poster Display Convex Boxes





See movie at our website www.mtdisplays.com.tr



Double sided display for indoor use. By the aid of snaps & hinged cover, one can easily change the poster on both sides. Brochure shelves can be added, if desired. Convex elegant look at eye-level to present your message.

 Product is packed unassembled with an easy to understand instruction sheet & fixing hardware.

 Heavy and stable base for public spaces. PVC hinged door, magnet cover & poster pegs provide easy change of poster on both sides.

 Shelves should be ordered separately.

 3 packs. See info chart for pack sizes.

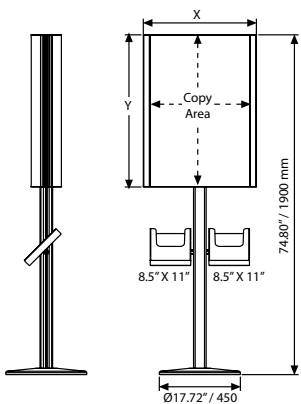

MATERIAL : Silver anodized aluminum				WEIGHT	PACKING SIZE
ARTICLE	EXTERNAL (x-y)	POSTER	COPY	WITH PACKING	*W X H X D
UTTM014301	19.57" X 25.57"	18" X 24"	17.13" X 23.13"	29.762 lbs	21.46" X 27.17" X 3.74"
UTTM014302	25.57" X 37.57"	24" X 36"	23.13" X 35.13"	32.628 lbs	23.82" X 31.50" X 3.74"

*W:Width H: Height D: Depth



Totems

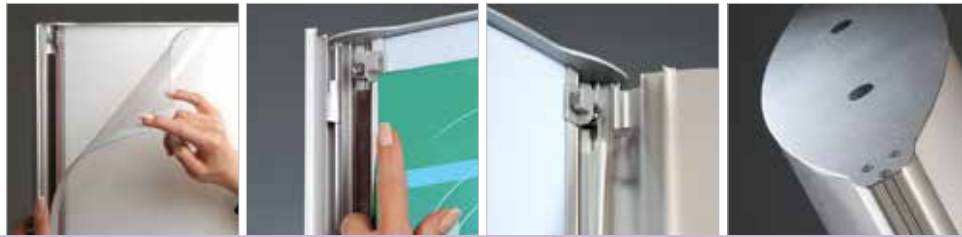

Stylish and practical free-standing light column. Illuminates posters printed on backlit film or duratrans. The snap frames enable you to change the display material easily whenever desired. Product is double sided. One can simply open the front profile to change the poster. The hinged door, magnetic cover closing & plastic pegs on both sides provide easy poster replacement.

Each unit is packed unassembled with an easy instruction sheet. Delivered with 2 m electrical cable & plug.

Each unit has a ventilation hole. PVC hinge on one side & magnetic cover allows for an easy change of the poster. All units have passed CE/UL Pat tests & are delivered with their certificates.

2 packs. See info chart for pack sizes.

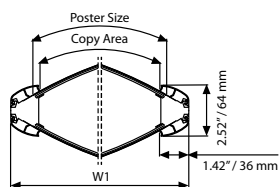
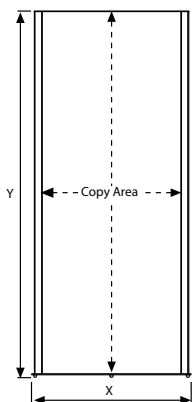
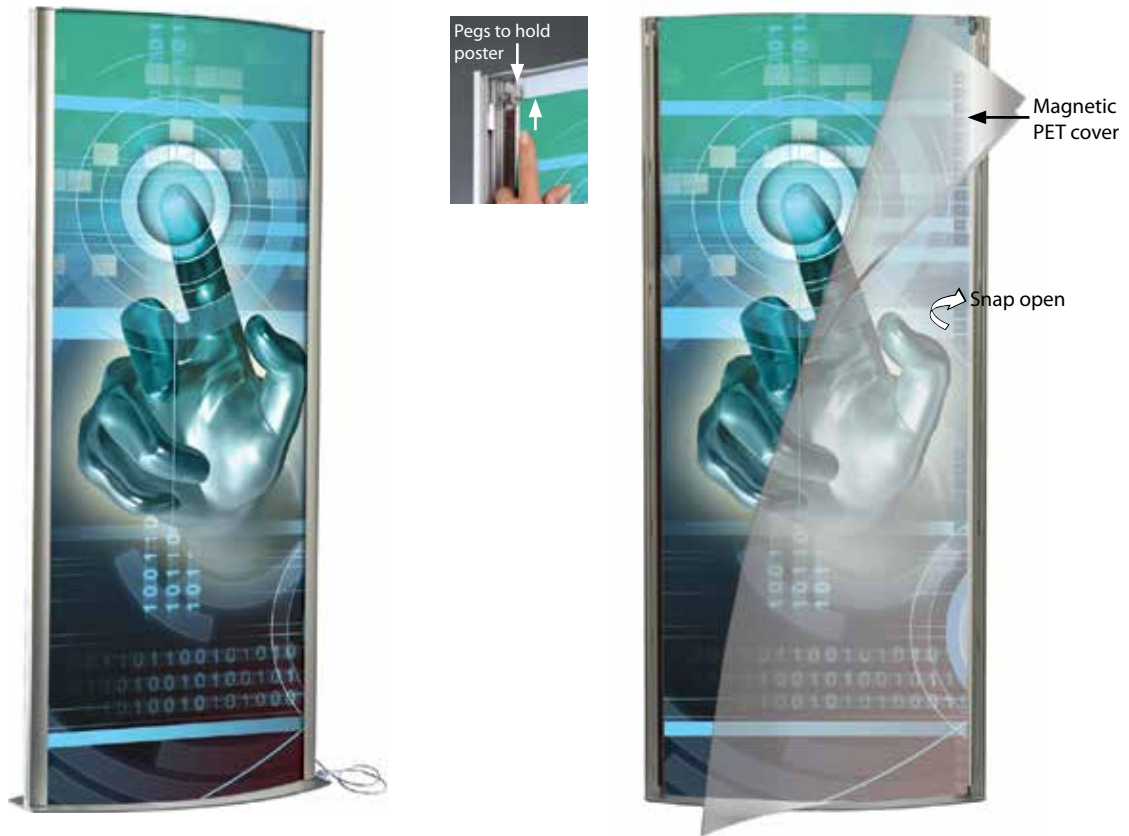

Top part
RAL 9006 grey
powdercoated

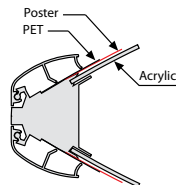
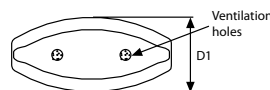

MATERIAL : Silver anodized aluminum							WEIGHT	PACKING SIZE
ARTICLE	EXTERNAL (x-y)	POSTER	COPY	D1	W1	LIGHTING	WITH PACKING	*W X H X D
UTTM002767	28.97" X 68.97"	27" X 67"	26.21" X 66.21"	13.58"	29.13"	2700-3300 LUX	65.106 lbs	30.91" X 46.06" X 3.74" / 14.57" X 30.12" X 1.57"
UTTM002777	28.97" X 78.97"	27" X 77"	26.21" X 76.21"	13.58"	29.13"	2700-3300 LUX	71.500 lbs	30.91" X 80.71" X 3.35" / 14.57" X 30.12" X 1.57"

*W:Width H: Height D: Depth





Decorative Totem



See movie at our website www.mtdisplays.com.tr



The elegant looking decorative Totem is designed with a patterned polystyrene panel at the bottom. The snap frames enable you to change the display material easily whenever desired. Product is double sided. One can simply open the front profile to change the poster. The hinged door, magnetic cover & plastic pegs on both sides, provide easy poster replacement.

-  Each unit is packed unassembled with an easy to understand instruction sheet. Delivered with 2 m electrical cable & plug.
-  PVC hinge on one side & magnetic cover allows for an easy change of the poster. All units have passed CE/UL Pat tests & are delivered with their certificates.
-  2 packs. See info chart for pack sizes.

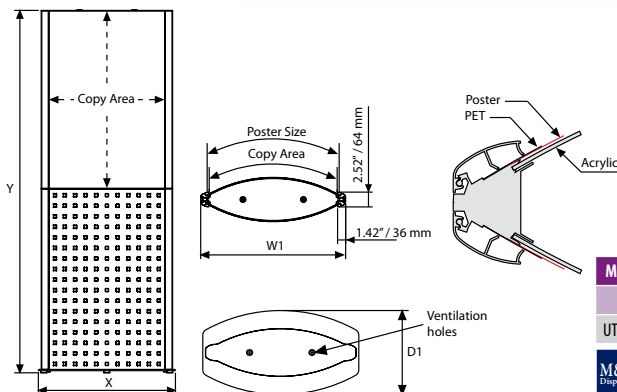
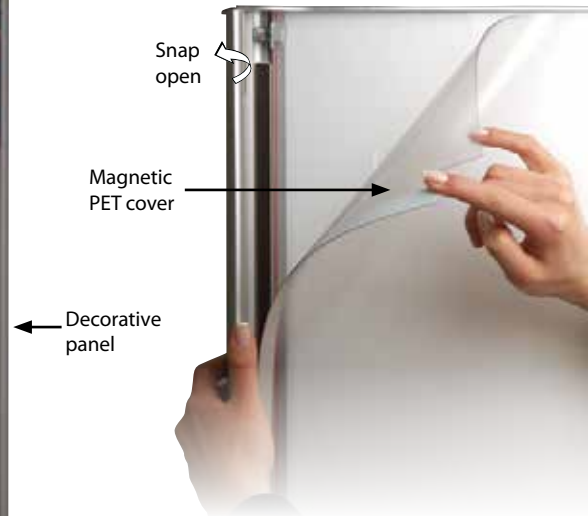

MATERIAL : Silver anodized aluminum							WEIGHT	PACKING SIZE
ARTICLE	EXTERNAL (x-y)	POSTER	COPY	D1	W1	LIGHTING	WITH PACKING	*W X H X D
UTTM011060	26.20" X 38.20"	24" X 36"	23.21" X 35.21"	13.78"	26.38"	2800-3400 LUX	39.38 lbs	31.5" X 68.9" X 35.43"





*W:Width H: Height D: Depth



Mono Totems



Non-snap Mono Totem is offered with and without light. Poster is placed on 2 long sides by slide-in profile channel. Available sizes are 19.6" x 67" and 23.6" x 67". Mono Totem is a double sided display. Smooth & durable aluminum construction provides stability. For illuminating options, please contact your Sales Executive.

-  Each unit is packed unassembled with an easy to understand instruction sheet and fixing hardware for assembly.
-  Heavy elegant base provides stability.
-  All illuminated items pass CE/UL tests and are delivered with certificates.
-  2 packs. See info chart for pack sizes.



Mono Totem



Mono Totem with Light

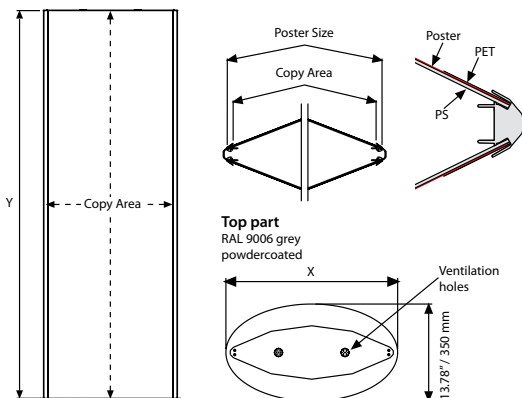

MATERIAL : Silver anodized aluminum					WEIGHT	PACKING SIZE
ARTICLE	EXTERNAL (x-y)	POSTER	COPY	DESCRIPTION	WITH PACKING	*W X H X D
UTTME10500	20.5" X 67"	19.5" X 67"	18.5" X 67"	without light	39.683 lbs	22.44" X 68.90" X 2.36" / 14.57" X 21.26" X 1.57"
UTTME10600	24.5" X 67"	23.5" X 67"	22.5" X 67"	without light	44.092 lbs	26.38" X 68.90" X 2.36" / 14.57" X 25.20" X 1.57"
UTTME00500	20.5" X 67"	19.5" X 67"	18.5" X 67"	with light	41.887 lbs	22.44" X 68.90" X 2.36" / 14.57" X 21.26" X 1.57"
UTTME00600	24.5" X 67"	23.5" X 67"	22.5" X 67"	with light	46.297 lbs	26.38" X 68.90" X 2.36" / 14.57" X 25.20" X 1.57"
UTTME00000	23.2" X 67"	27" X 67"	25.8" X 67"	without light	41.887 lbs	29.72" X 67.72" X 2.36" / 14.57" X 25.20" X 1.57"



*W:Width H: Height D: Depth

LEDA Illuminated Magnetic Totem



See movie at our website www.mtdisplays.com.tr

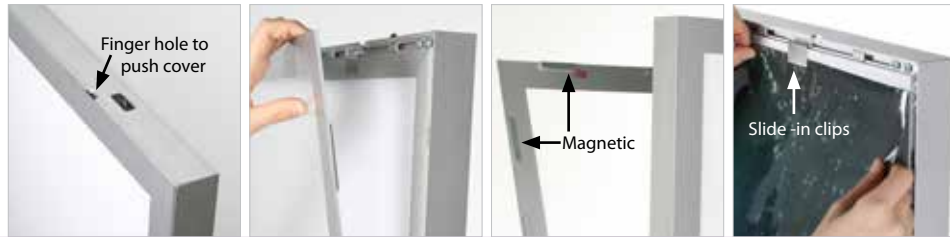

Indoor large display, LEDA is a slim LED illuminated totem. High quality LEDA provides bright images with high illumination. Magnetic acrylic cover has a hidden access so it prevents from public access easily. It is made of powder coated steel base and aluminium profiles to provide stability. Easy to assemble with enclosed mounting instructions.

All units pass CE/UL PAT tests and are supplied with their quality certificates. Delivered with 2,5 meter long cable and EU plug. UK and US plugs should be specified with order.

LED illumination saves up to 60% energy costs (compared to fluorescent technology).

Complete with low voltage 6A powersupply.

2 packs. See info chart for pack sizes.

Color options : Silver & black
Farbenoptionen : Schwarz und silber.



- Improved LED technology for improved luminance
- Pre-treated light guided panel diffuses light even & powerful.
- CE listed electrical components.
- Offers evenly diffused lux
- Saves up to 60% energy costs.

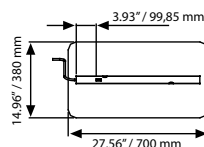
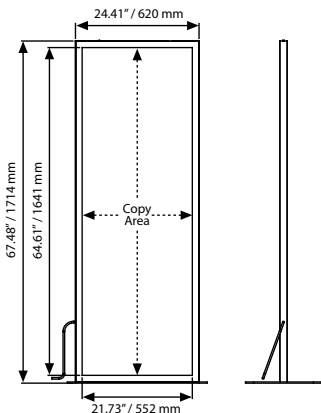

MATERIAL : Silver & black anodised aluminium						WEIGHT	PACKING SIZE
ARTICLE	DESCRIPTION	EXTERNAL (x-y)	POSTER	COPY	LIGHTING	WITH PACKING	*W X H X D
UMLD37B000	Black	24.41" X 67.24"	23.39" X 66.22"	21.73" X 64.61"	1900-2100 LUX	91.491 lbs	27.17" X 70.87" X 3.35" / 16.14" X 29.13" X 1.18"
UMLD37N000	Silver	24.41" X 67.24"	23.39" X 66.22"	21.73" X 64.61"	1900-2100 LUX	91.491 lbs	27.17" X 70.87" X 3.35" / 16.14" X 29.13" X 1.18"

*W:Width H:Height D:Depth



Totem LED Product Programme (Production & Availability)

Size Available	LEDA Magnetic TOTEM	TOTEM	Decorative TOTEM	Mono TOTEM
Product Size - Poster Size	double	double	double	double
24.41" x 67.24" - 23.38" x 66.22" / Black	UMLD37B000	X	X	X
24.41" x 67.24" - 23.38" x 66.22" / White	UMLD37N000	X	X	X
22.04" x 67.71" - 19.68" x 27.56"	X	X	UTTM011040	X
25.59" x 67.71" - 23.62" x 66.93"	X	UTTM001000	UTTM011010	X
29.52" x 67.71" - 27.56" x 66.93"	X	UTTM002000	UTTM011020	X
33.46" x 67.71" - 31.49" x 66.93"	X	UTTM003000	X	X
34.64" x 67.71" - 33.11" x 46.81"	X	X	UTTM011030	X
20.47" x 66.93" - 19.68" x 66.93" / without light	X	X	X	UTTME10500
24.41" x 66.93" - 23.62" x 66.93" / without light	X	X	X	UTTME10600
20.47" x 66.93" - 19.68" x 66.93" / With light	X	X	X	UTTME00500
24.41" x 66.93" - 23.62" x 66.93" / With light	X	X	X	UTTME00600
Max(w x h) inch	27.56" x 78.74"	31.49" x 78.74"	34.64" x 67.71"	27.56" x 78.74"

Power Consumption	LEDA Magnetic TOTEM	TOTEM	Decorative TOTEM	Mono TOTEM
Product Size - Poster Size	double	double	double	double
24.41" x 67.24" - 23.38" x 66.22" / Black	63W / 5,2A	X	X	X
24.41" x 67.24" - 23.38" x 66.22" / White	63W / 5,2A	X	X	X
22.04" x 67.71" - 19.68" x 27.56"	X	X	18W (fluorescent)	X
25.59" x 67.71" - 23.62" x 66.93"	X	58W (fluorescent)	18W (fluorescent)	X
29.52" x 67.71" - 27.56" x 66.93"	X	58W (fluorescent)	36W (fluorescent)	X
33.46" x 67.71" - 31.49" x 66.93"	X	2 x 58W (fluorescent)	X	X
34.64" x 67.71" - 33.11" x 46.81"	X	X	2 x 36W (fluorescent)	X
20.47" x 66.93" - 19.68" x 66.93" / without light	X	X	X	58W (fluorescent)
24.41" x 66.93" - 23.62" x 66.93" / without light	X	X	X	58W (fluorescent)
20.47" x 66.93" - 19.68" x 66.93" / With light	X	X	X	58W (fluorescent)
24.41" x 66.93" - 23.62" x 66.93" / With light	X	X	X	58W (fluorescent)

Power Supply Recommended (12 Vdc, Ampere)	LEDA Magnetic TOTEM	TOTEM	Decorative TOTEM	Mono TOTEM
Product Size - Poster Size	double	double	double	double
24.41" x 67.24" - 23.38" x 66.22" / Black	6A	X	X	X
24.41" x 67.24" - 23.38" x 66.22" / White	6A	X	X	X
22.04" x 67.71" - 19.68" x 27.56"	X	X	Electronic Ballast	X
25.59" x 67.71" - 23.62" x 66.93"	X	Electronic Ballast	Electronic Ballast	X
29.52" x 67.71" - 27.56" x 66.93"	X	Electronic Ballast	Electronic Ballast	X
33.46" x 67.71" - 31.49" x 66.93"	X	Electronic Ballast	X	X
34.64" x 67.71" - 33.11" x 46.81"	X	X	Electronic Ballast	X
20.47" x 66.93" - 19.68" x 66.93" / without light	X	X	X	Electronic Ballast
24.41" x 66.93" - 23.62" x 66.93" / without light	X	X	X	Electronic Ballast
20.47" x 66.93" - 19.68" x 66.93" / With light	X	X	X	Electronic Ballast
24.41" x 66.93" - 23.62" x 66.93" / With light	X	X	X	Electronic Ballast

LUX	LEDA Magnetic TOTEM	TOTEM	Decorative TOTEM	Mono TOTEM
Product Size - Poster Size	double	double	double	double
24.41" x 67.24" - 23.38" x 66.22" / Black	1900-2100	X	X	X
24.41" x 67.24" - 23.38" x 66.22" / White	1900-2100	X	X	X
22.04" x 67.71" - 19.68" x 27.56"	X	X	1500-1900	X
25.59" x 67.71" - 23.62" x 66.93"	X	1700-2000	1500-1800	X
29.52" x 67.71" - 27.56" x 66.93"	X	1700-2000	1700-2000	X
33.46" x 67.71" - 31.49" x 66.93"	X	2300-2700	X	X
34.64" x 67.71" - 33.11" x 46.81"	X	X	1700-2000	X
20.47" x 66.93" - 19.68" x 66.93" / without light	X	X	X	1900-2200
24.41" x 66.93" - 23.62" x 66.93" / without light	X	X	X	1900-2200
20.47" x 66.93" - 19.68" x 66.93" / With light	X	X	X	1900-2200
24.41" x 66.93" - 23.62" x 66.93" / With light	X	X	X	1900-2200

- ✓ Standard colour: Silver Anodised
- ✓ Available in RAL colours (subject to MOQ)
- ✓ Power supply is provided with the unit to suit each of the product
- ✓ Luminance: 2000-3000lux (depending on size)
- ✓ Standard Packaging: Single units in polybag and box
- ✓ Low power consumption (see above average power consumption table for each size)
- ✓ Various plugs available such as European, UK, US and Australian
- ✓ Complies with EN55015 & EN61547.

POWER SUPPLY	
ARTICLE	DESCRIPTION
UYPLD00010	Power supply EU 3,34A 7/24
UYPLD00011	Power supply EU 6,67A 7/24
UYPLD00012	Power supply EU 8,5A 7/24
UYPLD00013	Power supply EU 11,5A 7/24

- ✓ Products are suitable to use 7/16.
- ✓ If 7/24 use required, please order individually as 7/24 power supplies as below:



In case of any claim, user is required to return product or any parts to manufacture for analyses at their cost. As long as the manufacturer confirms the problem is a manufacturing fault, the replacement can be provided. This applies for all illuminated products.





Literature Racks

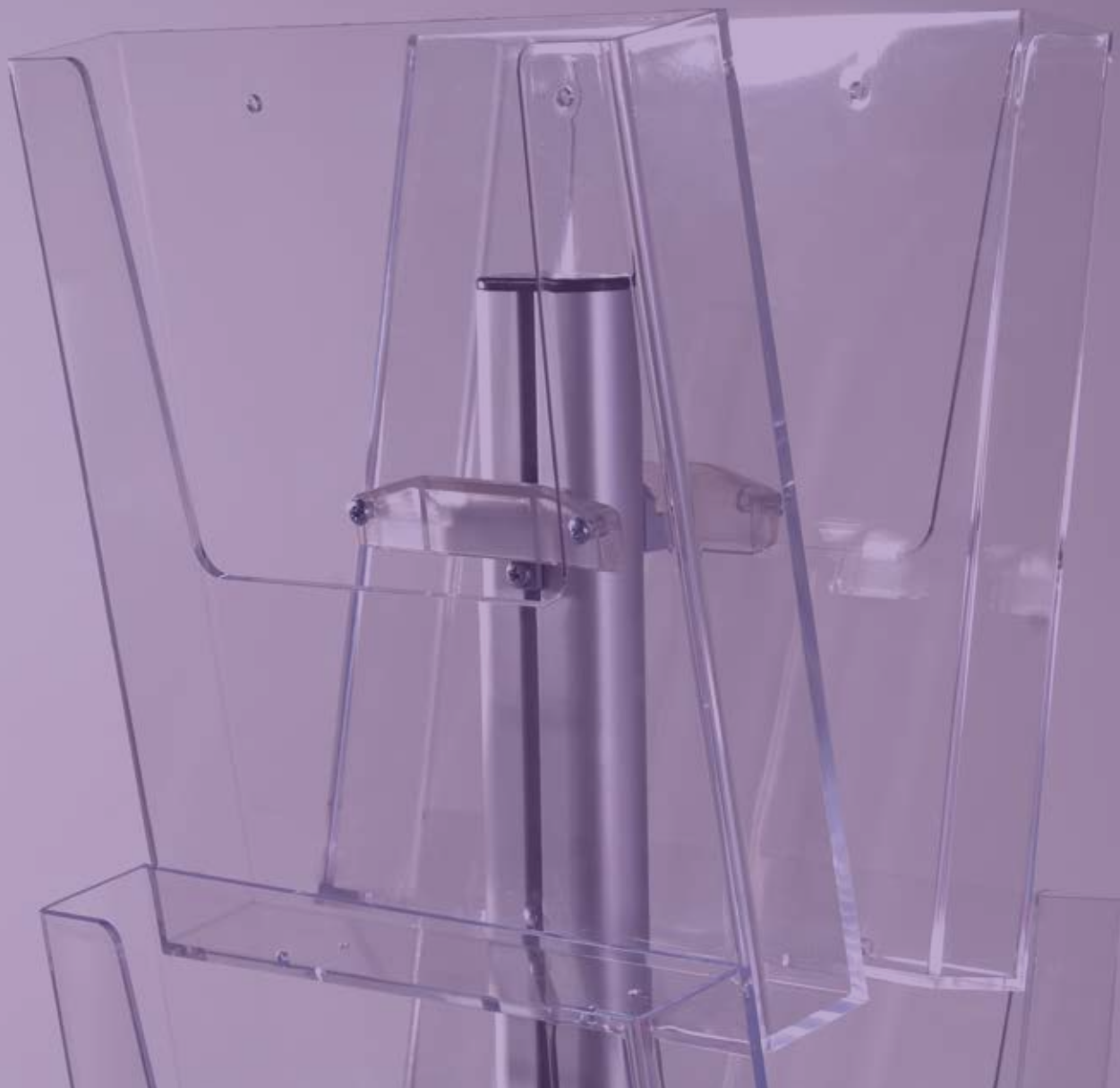

- Free Standing Leaflet with Side Shelves
- Cocktail Brochure Sets
- Cocktail Brochure Sets for Wall
- Prime Wall Units
- Portable Leaflet Dispensers
- Multiside Brochure Sets
- Brochure Sets
- Decorative Brochure Stands
- Decorative Brochure Stands Plus
- Pillar Brochure Stands
- Zick-Zacks
- Double Leg Zick-Zacks
- Zic-Zack Lites
- Rapid Brochure Set
- Curved Reversible Tower Brochure Stand
- Twin Reversible Tower Brochure Stand
- Convex Reversible Tower Brochure Stand
- Double Sided Reversible Tower Brochure Stand
- Basic Reversible Tower Brochure Stand
- Reversible Tower Brochure Stand for Wall
- Newage Portable Zick-Zacks
- Portable Zick-Zacks
- Wood Zick-Zack **NEW**
- Monoblocks



Free Standing Leaflet with Side Shelves



An ideal brochure stand that allows various different models for indoor use. The fixing grooves on both sides of the central pole hold slide-in frame one alone or more at the same time. Each Frame comes along with the required fixing components. The elegant look brochure holder is designed to hold maximally 8x8.5" X 11" brochure sets at a time. The acrylic logo header at size of 6.30 x 17.72".

-  Product is packed unassembled with an easy mounting instruction sheet & fixing hardware.
-  Allows multiple variation, heavy & stable base for public space. Each slide-in frame includes a poster protective set of 2 clear + 1 black sheet which prevent the light transmission.
-  2 packs. See info chart for pack sizes.



Free Standing Leaflet with Side Shelves



Free Standing Leaflet Dispensers

Free Standing Leaflet with Side Shelves

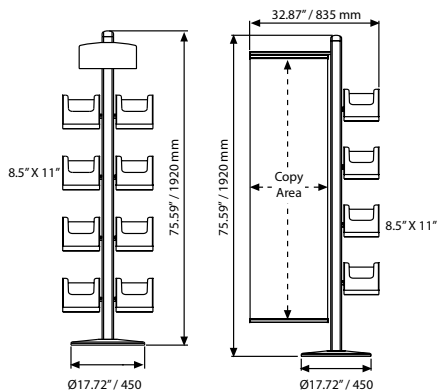

Free Standing Leaflet Dispensers

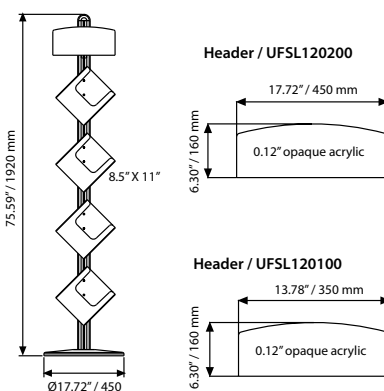

LEAFLET DISPENSERS : Clear Acrylic			WEIGHT	PACKING SIZE
ARTICLE	DESCRIPTION	SIZE	WITH PACKING	*W X H X D
UFSL120000	Acrylic Shelf	8.5" X 11"	0.90 lbs	10.63" X 9.65" X 2.17"
UFSL120100	Header	13.78" X 6.30"	0.66 lbs	7.68" X 14.37" X 0.87"
UFSL001000	Main body pole	75.59"	7.60 lbs	3.15" X 76.77" X 3.15"
	Main body base	Ø17.72"	19.73 lbs	19.29" X 19.29" X 1.97"

SIDE SHELF : Clear Acrylic			WEIGHT	PACKING SIZE
ARTICLE	DESCRIPTION	SIZE	WITH PACKING	*W X H X D
UFSL145000	Acrylic Shelf	8.5" X 11"	1.82 lbs	10.63" X 9.65" X 2.17"
UFSL120200	Header	17.72" X 6.30"	0.66 lbs	6.89" X 18.31" X 2.17"
UFSL001000	Main body pole	75.59"	7.60 lbs	3.15" X 76.77" X 3.15"
	Main body base	Ø 17.72"	19.73 lbs	19.29" X 19.29" X 1.97"

*W:Width H: Height D: Depth



Coctail Brochure Sets



See movie at our website www.mtdisplays.com.tr



Easy to build, stylish brochure holder.
Designed to hold various brochures.
The connector structure offers you space for individual adjustment of the shelves.
Main body and required quantities of shelves need to be ordered separately.



Product is packed unassembled with an easy mounting instruction sheet & fixing hardware.



There are four plastic feet under the base.



Please gently push the shelves over the connectors on the pole. The shelf connectors arrive at fixed positions on the profile. For individual adjustment please loosen the screws to move back and forth.



2 packs. See info chart for pack sizes.

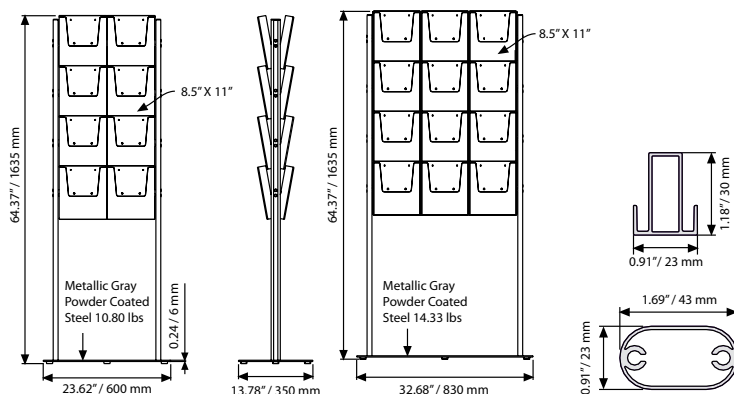

MATERIAL : Silver anodized aluminum & acrylic shelf			WEIGHT	PACKING SIZE
ARTICLE	DESCRIPTION	SIZE	WITH PACKING	*W X H X D
UCBSG00024	Main body	2 X (8.5" X 11")	8.59 lbs	20.67" X 64.57" X 2.17"
			11.68 lbs	15.16" X 24.80" X 1.18"
UCBSG00034	Main body	3 X (8.5" X 11")	13.33 lbs	29.53" X 64.57" X 2.17"
			12.45 lbs	15.16" X 33.86" X 1.18"
UMSDA008A4	Acrylic Shelf & Adapter	8 X (8.5" X 11")	7.82 lbs	10.63" X 13.39" X 9.45" (8 Pcs)
UMSD008100	Acrylic Shelf	8.5" X 11"	28.43 lbs	20.47" X 24.80" X 9.84" (30 Pcs)
UYUP490000	Adapter		0.46 lbs	10 Pcs

*W:Width H: Height D: Depth



Coctail Brochure Sets for Wall



Stunning and Innovative brochure holders that are designed to hold various pieces of acrylic brochure holders side by side at a time.

 Product is packed unasssembled with an easy mounting instruction sheet & fixing hardware.

 Products is available in semi-finished index for various other applications.



2 pcs X 5.5" X 8.5"

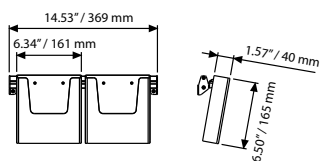

3 pcs X 4" X 6"

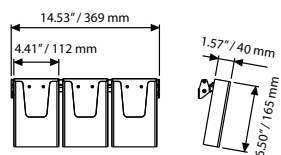

2 pcs x 8.5" X 11"

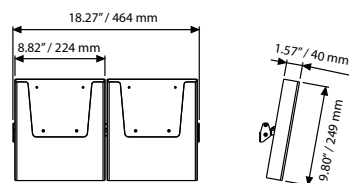

MATERIAL : Clear Acrylic		WEIGHT	PACKING SIZE
ARTICLE	POSTER	WITH PACKING	*W X H X D
UCBSW200A4	8.5" X 11"	2.97 lbs	10.63" X 19.69" X 3.54"
UCBSW200A5	5.5" X 8.5"	1.87 lbs	7.28" X 15.94" X 3.54"
UCBSW30A43	4" X 6"	2.182 lbs	7.28" X 15.94" X 3.54"





*W:Width H: Height D: Depth

Prime Wall Units



Multiple-pocket leaflet dispenser, Prime Wall Unit tidies up the busy environment. It is also important tool for use in any office, lobby retail store or bank. The main body is produced by polystyrene material. This thermoformed body in aesthetic shape provides easy access to the leaflets or brochures. Clear PET-G pockets provide a full view of flyers or brochures stored in.

 Available in White, Black and Grey.

 Pocket capacity:
A4 also suitable for 8.5"x11"
A5 also suitable for 6.5"x8"
A4/3 also suitable for 4"x9"

 Supplied with wall fixings.

Color options



3x(8.5"x11") White



3x(8.5"x11") Gray



4x(6.5"x8") White



4x(4"x9") Black



3X (8.5"x11") White

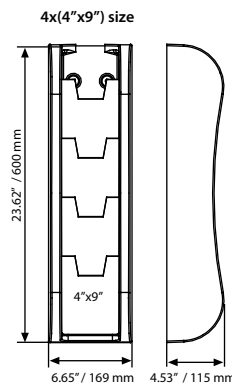
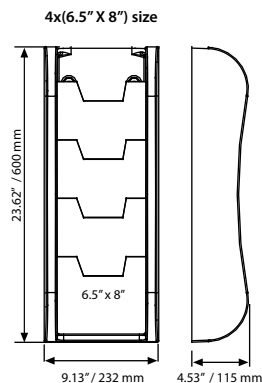
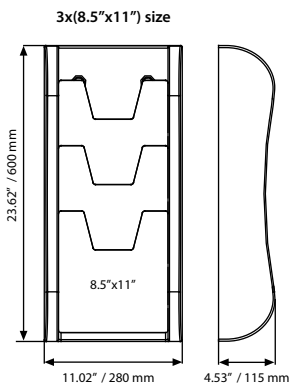

MATERIAL : PET-G & Clear Acrylic			WEIGHT	PACKING SIZE
ARTICLE	CAPACITY	DESCRIPTION	WITH PACKING	*W X H X D
UPWOG003A4	3 X (8.5"x11")	Gray	3.593 lbs	12.20" X 24.80" X 5.51"
UPWOB003A4	3 X (8.5"x11")	Black	3.593 lbs	12.20" X 24.80" X 5.51"
UPWOW003A4	3 X (8.5"x11")	White	3.593 lbs	12.20" X 24.80" X 5.51"
UPWOG004A5	4 X (6.5"x8")	Gray	3.196 lbs	10.24" X 24.80" X 5.51"
UPWOB004A5	4 X (6.5"x8")	Black	3.196 lbs	10.24" X 24.80" X 5.51"
UPWOW004A5	4 X (6.5"x8")	White	3.196 lbs	10.24" X 24.80" X 5.51"
UPWOG04A3	4 X (4"x9")	Gray	2.777 lbs	7.87" X 24.80" X 5.51"
UPWOB04A3	4 X (4"x9")	Black	2.777 lbs	7.87" X 24.80" X 5.51"
UPWOW04A3	4 X (4"x9")	White	2.777 lbs	7.87" X 24.80" X 5.51"

*W:Width H:Height D:Depth



Portable Leaflet Dispensers



Made of polycarbonate, Portable Leaflet Dispensers provide both flexibility and saving from the space in the offices, shops and hotels and more. Transparent pockets offer a complete view of the brochure or fliers.

💡 Complete with fixing components.

! Additional pocket are available by order.



3 X (8.5"X11")



4 X (6.5"X8")



4 X (4"X9")

← Flexible scratch resistant PC body

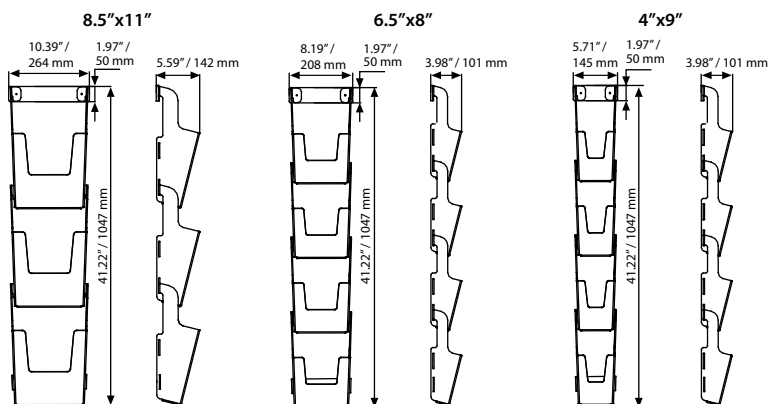

MATERIAL : Polycarbonate		WEIGHT	PACKING SIZE
ARTICLE	CAPACITY	WITH PACKING	*W X H X D
UPBW0030A4	3 X (8.5" X 11")	2,579 lbs	10.63" X 21.26" X 5.91"
UPBW0040A5	4 X (6.5" X 8")	3,262 lbs	5.91" X 21.26" X 4.72"
UPBW004A43	4 X (4" X 9")	4,188 lbs	8.46" X 21.26" X 4.72"

*W:Width H: Height D: Depth



Multiside Brochure Sets 1 Pole



Multiside Brochure sets are developed to provide multiple variations at low costs. Based on 1, 3 or 4 poles, robust aluminum body with height of 1.5 meters, various number of shelves can be fitted to make a brochure set meeting your exact needs. To complete a product, main body and required quantities of shelves need to be ordered separately. Brochure holders are quickly and easily inserted.

Product is packed unassembled with an easy to understand instruction sheet & fixing hardware.

Heavy & stable base for public spaces. There are 4 plastic feet under the base.

Shelves should be ordered separate. Please gently push the shelves over the connectors on the pole. The shelf connectors arrive at fixed positions. For individual adjustment please loosen the screws to move up and down.UMSDA008100 and UYUP490000 can be used to form UMSDA005A4 if you have them in your stock.

2 packs. See info chart for pack sizes.



UMBLG20523

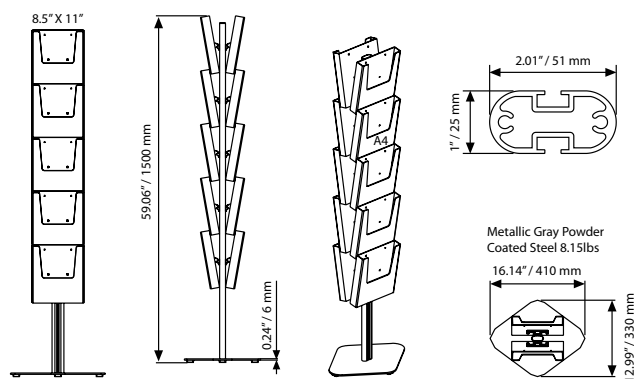

MATERIAL : Anodized aluminum & clear acrylic			WEIGHT	PACKING SIZE
ARTICLE	DESCRIPTION	SIZE	WITH PACKING	*W X H X D
UMBSG205A4	Main body	5X (8.5" X 11")	4.16 lbs 9.01 lbs	2.56" X 59.84" X 2.56" 13.39" X 18.11" X 1.18"
UMBSG205A5	Main body	5 X (5.5" X 8.5")	4.16 lbs 9.01 lbs	2.56" X 59.84" X 2.56" 13.39" X 18.11" X 1.18"
UMBSG20523	Main body	5 X 2 (4" X 6")	4.16 lbs 9.01 lbs	2.56" X 59.84" X 2.56" 13.39" X 18.11" X 1.18"
UMSDA005A4	Acrylic Shelf & Adapter	8.5" X 11"	5.51 lbs	7.09" X 9.45" X 7.09" (5 Pcs)
UMSDA012A4	Acrylic Shelf & Adapter	8.5" X 11"	13.22 lbs	10.63" X 15.75" X 10.63" (12 Pcs)
UMSDA000A5	Acrylic Shelf & Adapter	5.5" X 8.5"	7.05 lbs	11.42" X 14.17" X 7.48" (12 Pcs)
UMSDA00A43	Acrylic Shelf & Adapter	4" X 6"	5.62 lbs	9.84" X 12.60" X 7.09" (12 Pcs)
UMSDA02A43	Acrylic Shelf & Adapter	2 X 4" X 6"	9.60 lbs	9.84" X 12.60" X 13.78" (12 Pcs)



*W:Width H: Height D: Depth



Multiside Brochure Set 3 Pole - 4 Pole



Multiside Brochure sets are developed to provide multiple variations at low costs. Based on 3 pole or 4 pole robust aluminum body at height of 59.06" different number of shelves can be fitted to make a brochure set which meets your exact needs. To complete a product, main body and required quantities of shelves need to be ordered separately. Brochure holders are quickly and easily inserted.

-  Product is packed unassembled with an easy to understand instruction sheet & fixing hardware.
-  Heavy & stable base for public spaces. There are 4 plastic feet under the base.
-  Shelves should be ordered separate. Please gently push the shelves over the connectors on the pole. The shelf connectors arrive at fixed positions. For individual adjustment please loosen the screws to move up and down.UMSDA008100 and UYUP490000 can be used to form UMSDA005A4 if you have them in your stock.

 2 packs. See info chart for pack sizes.

3 pole



3 Side Base
Metallic Gray Powder
Coated Steel 12.34 lbs

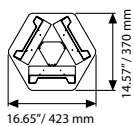

4 pole



4 Side Base
Metallic Gray Powder
Coated Steel 19.18 lbs

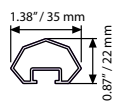
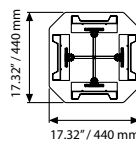

3 Side

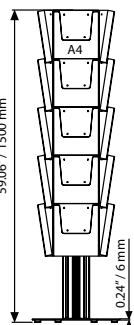

4 Side

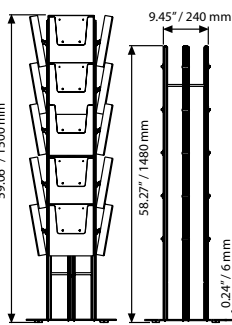

MATERIAL : Anodized aluminum & clear acrylic				WEIGHT 3 SIDE	PACKING SIZE 3 SIDE	WEIGHT 4 SIDE	PACKING SIZE 4 SIDE
3 SIDE	4 SIDE	DESCRIPTION	SIZE	WITH PACKING	*W X H X D	WITH PACKING	*W X H X D
UMBSG305A4	UMBSG405A4	Main body	5X (8.5" X 11")	4.16 lbs	2.56" X 59.84" X 2.56"	6.43 lbs	11.42" X 59.84" X 4.13 mm
				9.01 lbs	13.39" X 18.11" X 1.18"	20.01 lbs	18.11" X 18.11" X 1.18"
UMBSG305A5	UMBSG405A5	Main body	5 X (5.5" X 8.5")	4.16 lbs	2.56" X 59.84" X 2.56"	6.43 lbs	11.42" X 59.84" X 4.13 mm
				9.01 lbs	13.39" X 18.11" X 1.18"	20.01 lbs	18.11" X 18.11" X 1.18"
UMBSG30523	UMBSG40523	Main body	5 X 2 (4" X 6")	4.16 lbs	2.56" X 59.84" X 2.56"	6.43 lbs	11.42" X 59.84" X 4.13 mm
				9.01 lbs	13.39" X 18.11" X 1.18"	20.01 lbs	18.11" X 18.11" X 1.18"
UMSDA005A4	UMSDA005A4	Acrylic Shelf & Adapter	8.5" X 11"	5.51 lbs	7.09" X 9.45" X 7.09" (5 Pcs)	5.51 lbs	180 X 240 X 180 mm (5 Pcs)
UMSDA012A4	UMSDA012A4	Acrylic Shelf & Adapter	8.5" X 11"	13.22 lbs	10.63" X 15.75" X 10.63" (12 Pcs)	13.22 lbs	270 X 400 X 270 mm (12 Pcs)
UMSDA000A5	UMSDA000A5	Acrylic Shelf & Adapter	5.5" X 8.5"	7.05 lbs	11.42" X 14.17" X 7.48" (12 Pcs)	7.05 lbs	290 X 360 X 190 mm (12 Pcs)
UMSDA000A43	UMSDA000A43	Acrylic Shelf & Adapter	4" X 6"	5.62 lbs	9.84" X 12.60" X 7.09" (12 Pcs)	5.62 lbs	250 X 320 X 180 mm (12 Pcs)
UMSDA02A43	UMSDA02A43	Acrylic Shelf & Adapter	2 X 4" X 6"	9.60 lbs	9.84" X 12.60" X 13.78" (12 Pcs)	9.60 lbs	250 X 320 X 350 mm (12 Pcs)



*W:Width H: Height D: Depth



Multiside Brochure Set on Wheels



Multiside Brochure sets are developed to provide multiple variations at low costs. Based on 1 pole, 3 pole or 4 pole robust aluminium body at height of 62.99" meter, any number of shelves can be fitted to make a brochure set which meets your exact needs. To make a complete product, main body and required quantities of shelves need to be ordered separately. Product is freely rotatable and mobile in all directions over the wheels of the base providing flexibility in brochure presentation.

-  Product is packed unassembled with an easy mounting instruction sheet & fixing set.
-  Mobile & stable base for public space. There are 5 smooth rolling wheels under the base.
-  Shelves should be ordered separate. Please gently push the shelves over the connectors on the pole. The shelf connectors arrive at fixed positions. For individual adjustment please loosen the screws to move up and down. UMSDA008100 and UYUP490000 can be used to form UMSDA005A4 if you have them in your stock.

 Color options :
Silver-anodized & black



1 Pole Black

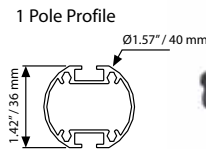

3 Pole Black



3 Pole Silver

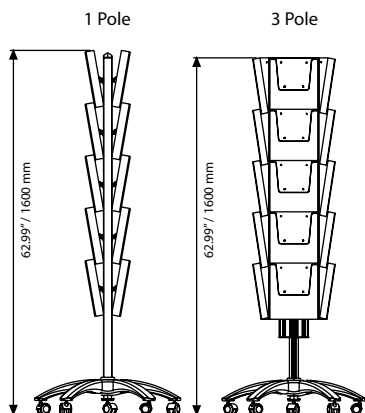
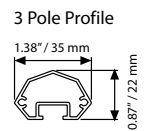

MATERIAL : Aluminum & clear acrylic

1 POLE	3 POLE	DESCRIPTION	SIZE
UMBSG2T5A4	UMBSG3T5A4	Silver main body	5 X (8.5" X 11")
UMBBG2T5A4	UMBBG3T5A4	Black main body	5 X (8.5" X 11")
UMSDA005A4	UMSDA005A4	Acrylic Shelf & Adapter	8.5" X 11"
UMSDA012A4	UMSDA012A4	Acrylic Shelf & Adapter	8.5" X 11"
UMSDA000A5	UMSDA000A5	Acrylic Shelf & Adapter	5.5" X 8.5"
UMSDA00A43	UMSDA00A43	Acrylic Shelf & Adapter	4" X 6"
UMSDA02A43	UMSDA02A43	Acrylic Shelf & Adapter	2 X 4" X 6"

1 POLE		3 POLE	
WEIGHT	PACKING SIZE	WEIGHT	PACKING SIZE
WITH PACKING	*W X H X D	WITH PACKING	*W X H X D
4.16 lbs	27.56" X 60.24" X 2.76"	4.18 lbs	6.69" X 52.36" X 5.75"
6.61 lbs	27.95" X 28.35" X 7.32"	8.60 lbs	27.95" X 28.35" X 7.32"
5.51 lbs	70.9 X 9.45" X 7.09" (5 Pcs)	5.51 lbs	70.9 X 9.45" X 7.09" (5 Pcs)
13.22 lbs	10.63" X 15.75" X 10.63" (12 Pcs)	13.22 lbs	10.63" X 15.75" X 10.63" (12 Pcs)
7.05 lbs	11.42" X 14.17" X 7.48" (12 Pcs)	7.05 lbs	11.42" X 14.17" X 7.48" (12 Pcs)
5.62 lbs	9.84" X 12.60" X 7.09" (12 Pcs)	5.62 lbs	9.84" X 12.60" X 7.09" (12 Pcs)
9.60 lbs	9.84" X 12.60" X 13.78" (12 Pcs)	9.60 lbs	9.84" X 12.60" X 13.78" (12 Pcs)





*W:Width H: Height D: Depth

Multiside Brochure Set Rotating



4 sided floor display, rotating on a central column which is mounted on a stable and elegant base. Height is 62.99", available in black and silver main body options. Shelves are clear in 8.5" X 11" all the time. Multiside Brochure sets have been developed to provide multiple variations at low costs. Different number of shelves can be fitted to make a brochure set which meets your exact needs.

-  Product is packed unasssembled with an easy mounting instruction sheet & fixing hardware.
-  Heavy & stable base for public space. While the main body is rotatable, the robust base is stable and still.
-  Shelves should be ordered separate. Please gently push the shelves over the connectors on the pole. The shelf connectors arrive at fixed positions. For individual adjustment please loosen the screws to move up and down. UMSD008100 and UYUP490000 can be used to form UMSDA008A4 if you have them in your stock.

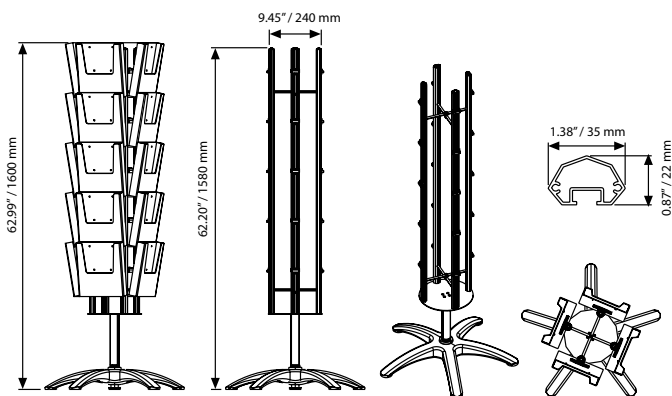

MATERIAL : Aluminum & clear acrylic			WEIGHT	PACKING SIZE
ARTICLE	DESCRIPTION	SIZE	WITH PACKING	*W X H X D
UMBSG4D5A4	Silver main body	5 X (8.5" X 11")	6.43 lbs	11.42" X 59.84" X 4.13"
UMBBG4D5A4	Black main body	5 X (8.5" X 11")	20.01 lbs	18.11" X 18.11" X 1.18"
UMSDA005A4	Acrylic Shelf & Adapter	8.5" X 11"	5.51 lbs	70.9 X 9.45" X 7.09" (5 Pcs)
UMSDA012A4	Acrylic Shelf & Adapter	8.5" X 11"	13.22 lbs	10.63" X 15.75" X 10.63" (12 Pcs)
UMSDA000A5	Acrylic Shelf & Adapter	5.5" X 8.5"	7.05 lbs	11.42" X 14.17" X 7.48" (12 Pcs)
UMSDA000A43	Acrylic Shelf & Adapter	4" X 6"	5.62 lbs	9.84" X 12.60" X 7.09" (12 Pcs)
UMSDA02A43	Acrylic Shelf & Adapter	2 X 4" X 6"	9.60 lbs	9.84" X 12.60" X 13.78" (12 Pcs)





*W:Width H: Height D: Depth

Brochure Sets



A brochure holder designed to hold brochures. When used with 4 wheels it is free and mobile. Single or double-faced options are available. Transparent shelves are made of 0.16" acrylic, the legs are made of aluminum.

 Product is packed unassembled with an easy to understand instruction sheet & fixing hardware.

 Wheels are optional, not included in the original pack. Shelves are packed separate in a protected box.



16 X 8.5" X 11" double sided



12 X 8.5" X 11" single sided



For wall

for Wall

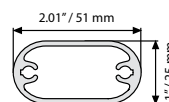
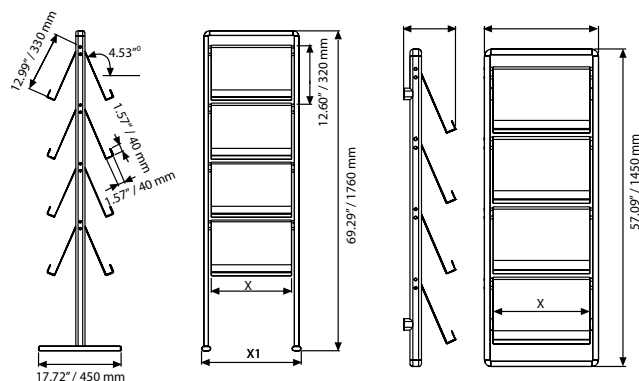

FOR WALL : Silver anodized aluminum & acrylic shelf			
ARTICLE	CAPACITY	WEIGHT	PACKING SIZE
		WITH PACKING	*W X H X D
UBSSD10N24	8 X (8.5" X 11")	28.660 lbs	21.65" X 59.06" X 5.12"

MATERIAL : Silver anodized aluminum & acrylic shelf				WEIGHT	PACKING SIZE
ARTICLE	CAPACITY	X	X1	WITH PACKING	*W X H X D
				UBSSC10N24	16 X (8.5" X 11") double sided
UBSST10N24	8 X (8.5" X 11") single sided	17.32"	21.50"	27.447 lbs	22.05" X 70.08" X 2.76"
UBSSC10N34	24 X (8.5" X 11") double sided	25.98"	30.16"	20.392 lbs	30.71" X 70.08" X 3.15"
UBSST10N34	12 X (8.5" X 11") single sided	25.98"	30.16"	34.943 lbs	30.71" X 70.08" X 2.76"
UBSSC10N44	32 X (8.5" X 11") double sided	34.65"	38.82"	24.802 lbs	39.37" X 70.08" X 3.15"
UBSST10N44	16 X (8.5" X 11") single sided	34.65"	38.82"	42.769 lbs	39.37" X 70.08" X 2.76"

*W:Width H: Height D: Depth





Decorative Brochure Stands

Decorative Brochure Stands Plus



Available in 8.5" x 11" size in portrait & landscape positions. Decorative Brochure Stand Plus is delivered with easy to change header on top.

 Brochure holders are made of 3 mm polycarbonate. Hard to scratch, not easy to break. Decorative brochures are packed unassembled with an easy to understand instruction sheet & fixing hardware.

 Heavy stable base for public spaces.



8.5" X 11" landscape

8.5" X 11" landscape with logo

8.5" X 11" portrait

8.5" X 11" portrait with logo

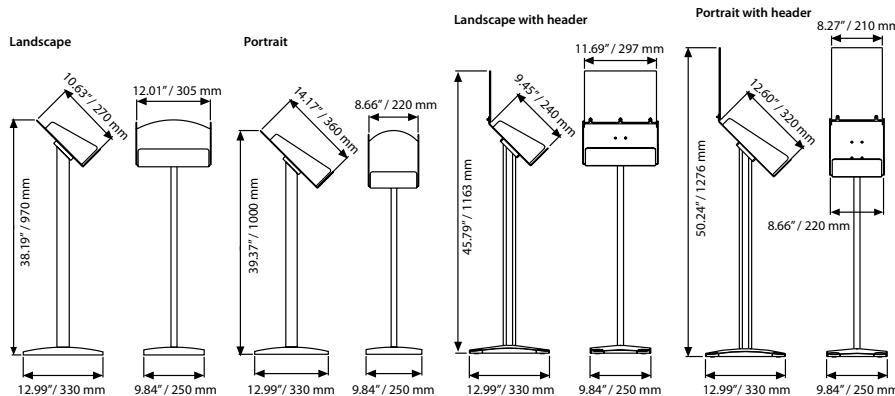

MATERIAL : Silver anodized aluminum & acrylic			
ARTICLE	DESCRIPTION	WEIGHT WITH PACKING	PACKING SIZE *W X H X D
UDBS20Y0A4	8.5" X 11" landscape with logo	8.774 lbs	11.02" X 34.65" X 4.92"
UDBS20D0A4	8.5" X 11" portrait with logo	8.774 lbs	11.02" X 34.65" X 4.92"
UDBS10Y0A4	8.5" X 11" landscape	7.605 lbs	11.02" X 34.65" X 4.92"
UDBS10D0A4	8.5" X 11" portrait	7.605 lbs	11.02" X 34.65" X 4.92"



*W:Width H: Height D: Depth

Pillar Brochure Stand



New selection of literature display including injected counter top with a robust aluminum body. 3 x 8.5" x 11" capacity and 6 x 4" x 6" capacity standards are available.

- Packed unassembled with instruction sheet & fixing hardware.
- Heavy stable base for public spaces.

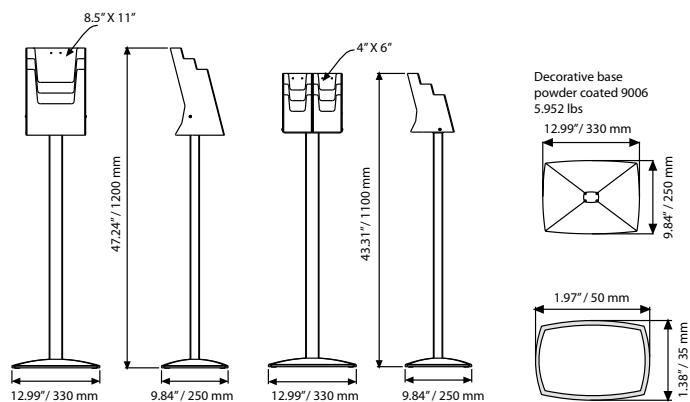

MATERIAL : Silver anodized aluminum & acrylic			
ARTICLE	SIZE	WEIGHT	PACKING SIZE
		WITH PACKING	*W X H X D
UPBS3000A4	8.5" X 11"	9.325 lbs	10.63" X 16.54" X 7.48"
		1.807 lbs	2.76" X 34.25" X 1.77"
UPBS300A43	4" X 6"	8.972 lbs	10.63" X 20.47" X 7.48"
		1.807 lbs	2.76" X 34.25" X 1.77"







*W:Width H: Height D: Depth

Zick-Zacks



Decorative legs are made of silver anodized aluminum ellipse profile, shelves are made of 0.39" acrylic. Metallic powder coated base is made up of 0.31" aluminum metallic powder coated base.

-  Product comes unassembled with instruction sheet.
-  Easy to change header. Heavy stable base is suitable for public spaces.
-  Use the hole caps in the hardware set to cover the mounting holes.
-  2 packs. See info chart for pack sizes.

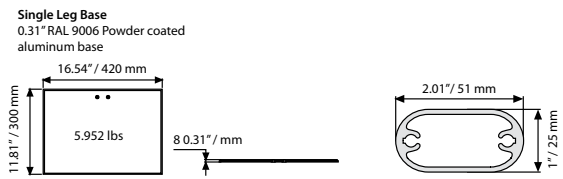
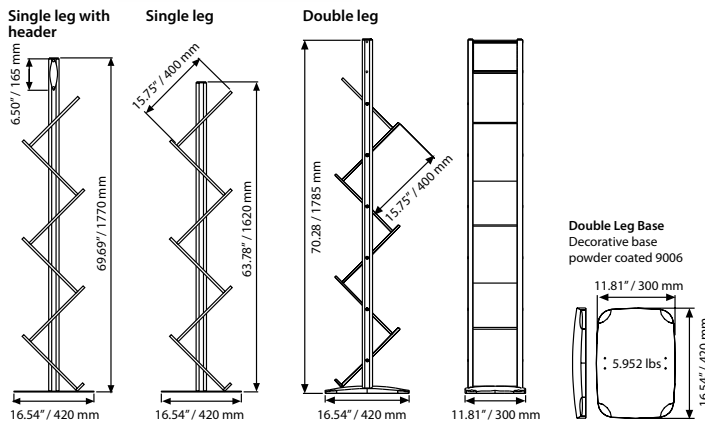
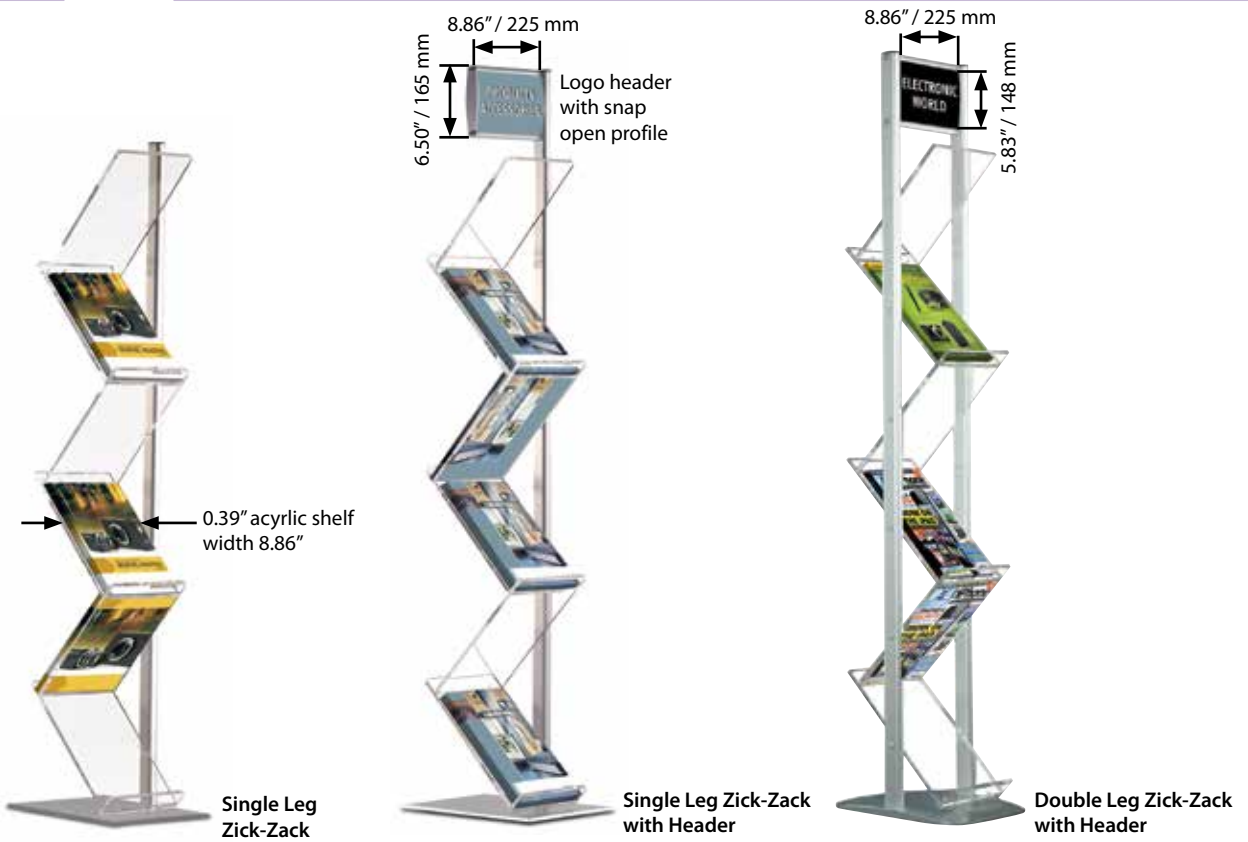



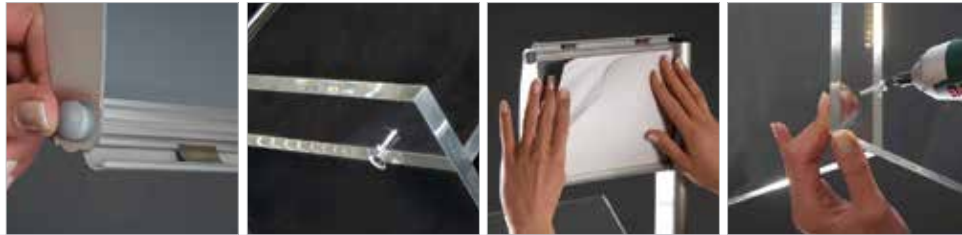

MATERIAL : Silver anodized aluminum		SHELF : Acrylic			
ARTICLE	MODELS	CAPACITY	WEIGHT	PACKING SIZE	
UZZTAC1001	Single leg	6 X (8.5" X 11")	25.022 lbs	12.99" X 17.32" X 5.12"	2.76" X 65.75" X 1.97"
UZZTAC1002	Single leg with header	6 X (8.5" X 11")	25.353 lbs	12.99" X 17.32" X 5.12"	2.76" X 71.65" X 1.97"
UZZCAC1002	Double Leg	6 X (8.5" X 11")	29.431 lbs	12.99" X 17.32" X 5.12"	2.76" X 71.65" X 1.97"

   *W:Width H: Height D: Depth

Zick-Zack Lites



Zick-Zack Lites are developed to provide 6 x (8.5"x11"). 8.5"x11" catalogs at one time. Based on metallic powder coated, semi-metal, plastic coated base; product stands stable on the floor in public places. Metallic color base is 9.479 lbs and transparent acrylic shelves are 0.31".

-  Product comes unassembled with instruction sheet.
-  Easy to change header. Heavy stable base is suitable for public spaces.
-  Use the hole caps in the hardware set to cover the mounting holes.
-  2 packs. See info chart for pack sizes.

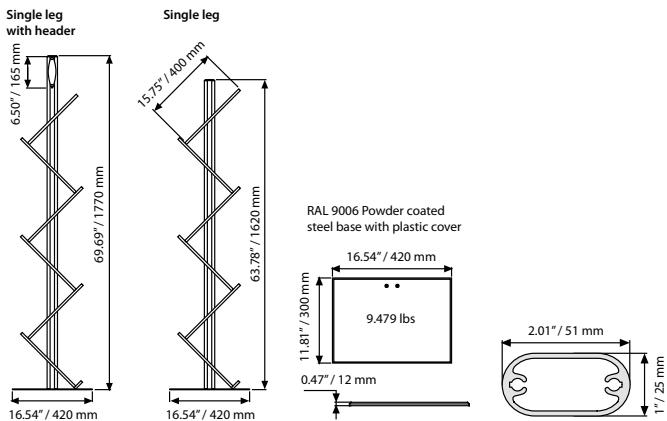
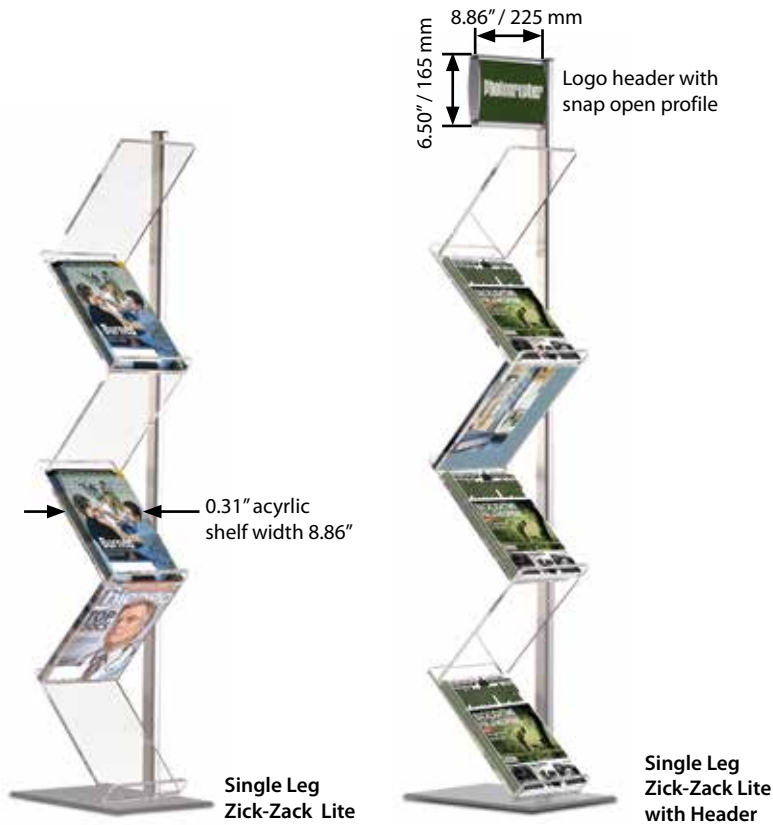

MATERIAL : Silver anodized aluminum		SHELF : Acrylic			
		WEIGHT		PACKING SIZE	
ARTICLE	MODELS	CAPACITY	WITH PACKING	SHELF & BASE	ELIPS PROFILE
UZZTLT0001	Single leg	6 X (8.5" X 11")	27.557 lbs	12.99" X 17.32" X 5.12"	2.76" X 65.75" X 1.97"
UZZTLT0002	Single leg with header	6 X (8.5" X 11")	27.557 lbs	12.99" X 17.32" X 5.12"	2.76" X 71.65" X 1.97"





*W:Width H: Height D: Depth

Rapid Brochure Sets



Rapid Brochure set has a stylish look. 8.5" X 11" shelves are made of frosted acrylic and easily placed on the aluminum poles. Boxed flat with unassembled shelves, it guarantees easy and safe transportation. Display your leaflets in retail stores or merchandising settings with Rapid brochure Sets. Header consists of 2 pieces. Front piece is clear and the back piece is frosted acrylic. You can put your paper poster in between the acrylics or apply printing directly on the clear or frosted acrylic pieces.

 Shelves are made of 4 mm frosted acrylic aluminum feet are powder coated.

 No tool assembly, easy to install & ready to use.

Color options



Silver Black

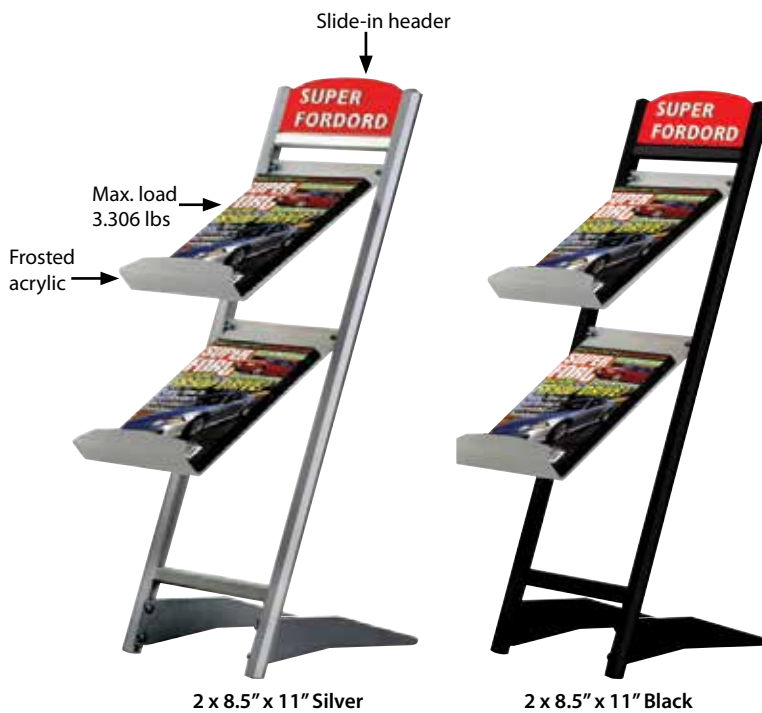

2 x 8.5" x 11" Silver

2 x 8.5" x 11" Black



3 x 8.5" x 11" Silver

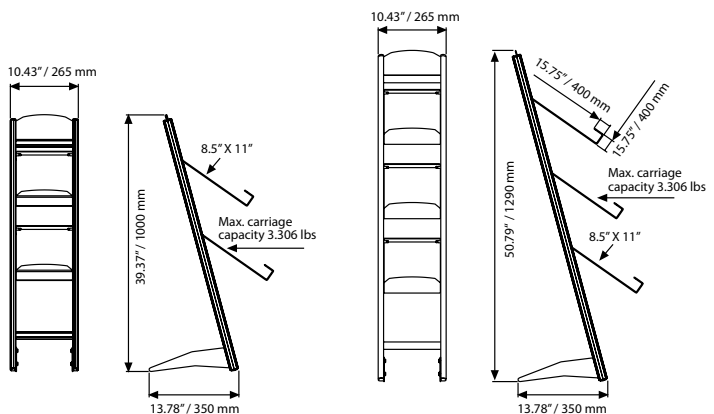

Header

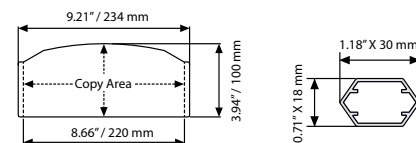

MATERIAL : Silver and black anodized

aluminum & acrylic		WEIGHT	PACKING SIZE
SILVER	BLACK	WITH PACKING	*W X H X D
URDB0002A4	URDBB002A4	7.936 lbs	11.02" X 41.73" X 2.17"
URDB0003A4	URDBB003A4	9.810 lbs	11.02" X 54.72" X 2.17"







*W:Width H: Height D: Depth

Curved Reversible Tower Brochure Stand



This single sided brochure stand is suitable for indoor use. It has an elegant curved design. Holes on the stand allows personalization of brochure placement and size according to need. 8.5"x11", 5.5"x8.5", 5"x7", 4"x6", 5.91" brochure holders are available. Quite stable with both its heavy base and design. Smooth lower part of brochure stand allows for branding.

-  Product is packed unassembled with an easy to understand instruction sheet for assembly.
-  Make your own stand design with desired variation of brochure holder placement and size.
-  Brochure holders should be ordered separately.
-  2 packs. See info chart for pack sizes.

Color options



Magnetic Pet Pocket
Please don't forget to order

PET POCKET		
PET POCKET	SIZE	COLOUR
UPCMOR00A4	8.5" X 11"	Red
UPCMB00A4	8.5" X 11"	Black
UPCMW00A4	8.5" X 11"	White
UPCMOG00A4	8.5" X 11"	Grey
UPCMOG00A5	5.5" X 8.5"	Grey
UPCMB00A5	5.5" X 8.5"	Black

RAL powder coated

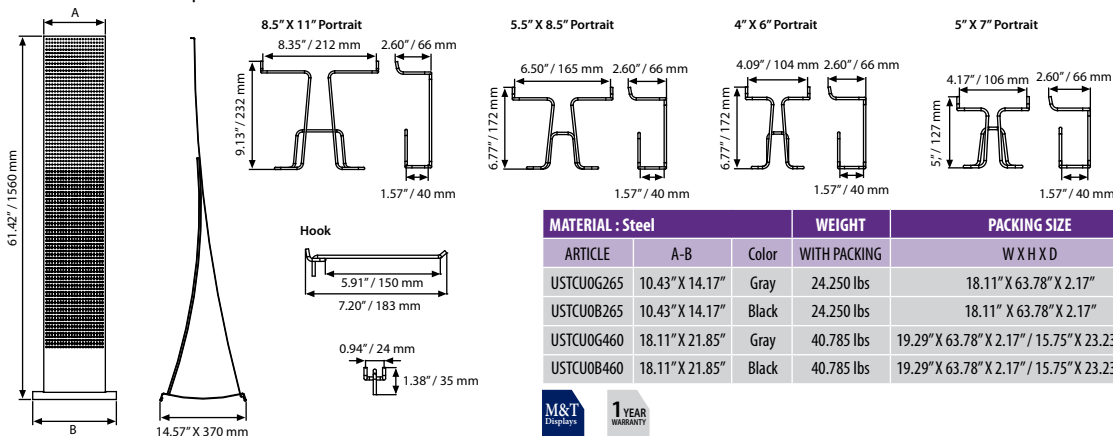

MATERIAL : Steel		WEIGHT	PACKING SIZE
ARTICLE	A-B	WITH PACKING	W X H X D
USTCU0G265	10.43" X 14.17"	24.250 lbs	18.11" X 63.78" X 2.17"
USTCU0B265	10.43" X 14.17"	24.250 lbs	18.11" X 63.78" X 2.17"
USTCU0G460	18.11" X 21.85"	40.785 lbs	19.29" X 63.78" X 2.17" / 15.75" X 23.23" X 1.97"
USTCU0B460	18.11" X 21.85"	40.785 lbs	19.29" X 63.78" X 2.17" / 15.75" X 23.23" X 1.97"

SHELF : Steel		
ARTICLE	SIZE	Color
UYPTSG00A4	8.5" X 11"	Gray
UYPTSB00A4	8.5" X 11"	Black
UYPTSG00A5	5.5" X 8.5"	Gray
UYPTSB00A5	5.5" X 8.5"	Black
UYPTSG00A6	5" X 7"	Gray
UYPTSB00A6	5" X 7"	Black
UYPTSG0A43	4" X 6"	Gray
UYPTSB0A43	4" X 6"	Black
UYPTSG0015	5.91"	Gray
UYPTSB0015	5.91"	Black

* W:Width H: Height D: Depth



Twin Reversible Tower Brochure Stand



Twin Tower Stand as double sided brochure stand is suitable for indoor use. Two elegant curved modules placed back to back provides space for more brochure holders.

Holes on the stand allows personalization of brochure placement and size according to needs. 8.5"x11", 5.5"x8.5", 5"x7", 4"x6", 5.91" brochure holders are available. Quite stable with both its heavy base and design. Smooth lower part of brochure stand allows for branding. Ideal for use at reception areas, educational institutions, travel agencies, hotels, offices, marketing events.

Product is packed unassembled with an easy to understand instruction sheet for assembly.

Make your own stand design with desired variation of brochure holder placement and size.

Brochure holders should be ordered separately.

2 packs. See info chart for pack sizes.

Color options



Don't forget to order brochure holders



RAL powder coated

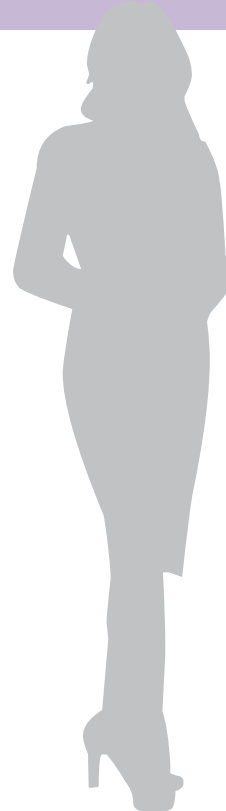

Magnetic Pet Pocket
Please don't forget to order

PET POCKET		
PET POCKET	SIZE	COLOUR
UPCMOR00A4	8.5" X 11"	Red
UPCMB00A4	8.5" X 11"	Black
UPCMOW00A4	8.5" X 11"	White
UPCMOG00A4	8.5" X 11"	Grey
UPCMOG00A5	5.5" X 8.5"	Grey
UPCMB00A5	5.5" X 8.5"	Black

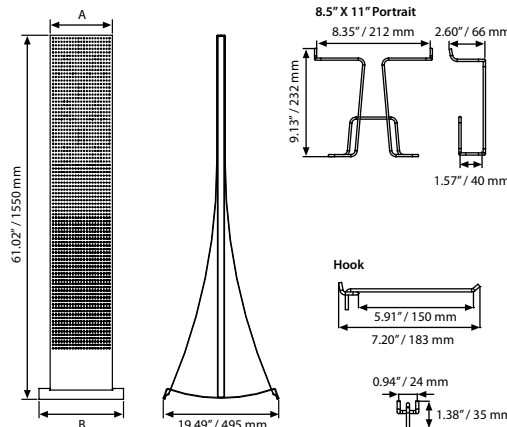

MATERIAL : Steel		WEIGHT		PACKING SIZE	
ARTICLE	A-B	Color	WITH PACKING	W X H X D	
USTTW0G265	10.43" X 14.17"	Gray	40.785 lbs	11.42" X 63.78" X 1.38" / 15.35" X 20.47" X 2.36"	
USTTW0B265	10.43" X 14.17"	Black	40.785 lbs	11.42" X 63.78" X 1.38" / 15.35" X 20.47" X 2.36"	
USTTW0G460	18.11" X 21.85"	Gray	65.036 lbs	18.90" X 63.78" X 1.38" / 20.47" X 23.23" X 2.36"	
USTTW0B460	18.11" X 21.85"	Black	65.036 lbs	18.90" X 63.78" X 1.38" / 20.47" X 23.23" X 2.36"	

SHELF : Steel		
ARTICLE	SIZE	Color
UYPTSG00A4	8.5" X 11"	Gray
UYPTS800A4	8.5" X 11"	Black
UYPTSG00A5	5.5" X 8.5"	Gray
UYPTS800A5	5.5" X 8.5"	Black
UYPTSG00A6	5" X 7"	Gray
UYPTS800A6	5" X 7"	Black
UYPTSG0A43	4" X 6"	Gray
UYPTS80A43	4" X 6"	Black
UYPTSG0015	5.91"	Gray
UYPTS80015	5.91"	Black

*W:Width H: Height D: Depth



Convex Reversible Tower Brochure Stand



See movie at our website www.mtdisplays.com.tr



This single sided brochure stand is suitable for use indoor. It has an elegant curved design. Holes on the stand allows personalization of brochure placement and size according to need. 8.5"x11", 5.5"x8.5", 5"x7", 4"x6", 5.91" brochure holders are available. Quite stable with both its heavy base and design. Smooth lower part of brochure stand allows for branding. Curved Tower Stand is ideal for use at reception areas, educational institutions, travel agencies, hotels, offices, marketing events.

Product is packed unassembled with an easy to understand instruction sheet for assembly.

Make your own stand design with desired variation of brochure holder placement and size.

Brochure holders should be ordered separately.

Color options



RAL powder coated



Magnetic Pet Pocket
Please don't forget to order

PET POCKET		
PET POCKET	SIZE	COLOUR
UPCMOR00A4	8.5" X 11"	Red
UPCMOB00A4	8.5" X 11"	Black
UPCMOW00A4	8.5" X 11"	White
UPCMOG00A4	8.5" X 11"	Grey
UPCMOG00A5	5.5" X 8.5"	Grey
UPCMOB00A5	5.5" X 8.5"	Black

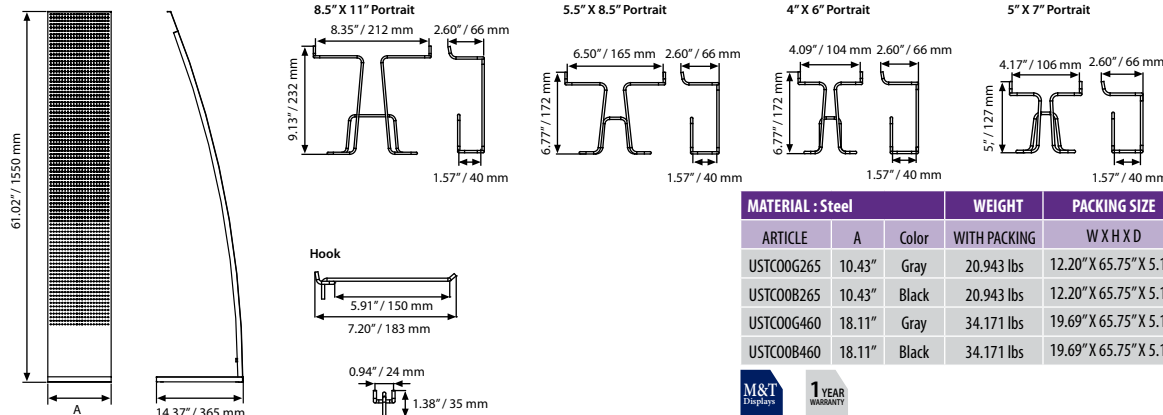

SHELF : Steel		
ARTICLE	SIZE	Color
UYPTS00A4	8.5" X 11"	Gray
UYPTS800A4	8.5" X 11"	Black
UYPTS00A5	5.5" X 8.5"	Gray
UYPTS800A5	5.5" X 8.5"	Black
UYPTS00A6	5" X 7"	Gray
UYPTS800A6	5" X 7"	Black
UYPTS0A43	4" X 6"	Gray
UYPTS8A43	4" X 6"	Black
UYPTS0015	5.91"	Gray
UYPTS80015	5.91"	Black

MATERIAL : Steel			WEIGHT	PACKING SIZE
ARTICLE	A	Color	WITH PACKING	W X H X D
USTCO0G265	10.43"	Gray	20.943 lbs	12.20" X 65.75" X 5.12"
USTCO0B265	10.43"	Black	20.943 lbs	12.20" X 65.75" X 5.12"
USTCO0G460	18.11"	Gray	34.171 lbs	19.69" X 65.75" X 5.12"
USTCO0B460	18.11"	Black	34.171 lbs	19.69" X 65.75" X 5.12"



* W:Width H: Height D: Depth

Double Sided Reversible Tower Brochure Stand



See movie at our website www.mtdisplays.com.tr

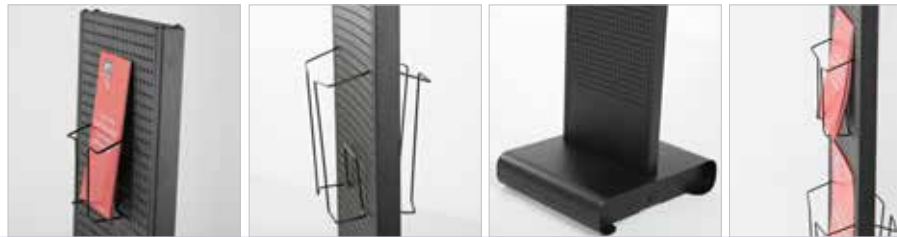

This double sided brochure Stand can be used indoor. Two straight modules back to back provides space for more brochure holders. Holes on the stand allows personalization of brochure placement and size according to needs. 8.5"x11", 5.5"x8.5", 5"x7", 4"x6", 5.91" brochure holders are available. Quite stable with both its heavy base and design. Smooth lower part of brochure stand allows for branding. Ideal for use at reception areas, educational institutions, travel agencies, hotels, offices, marketing events.

- Product is packed unassembled with an easy to understand instruction sheet for assembly.
- Make your own stand design with desired variation of brochure holder placement and size.
- Brochure holders should be ordered separately.
- 2 packs. See info chart for pack sizes.

Color options



RAL powder coated

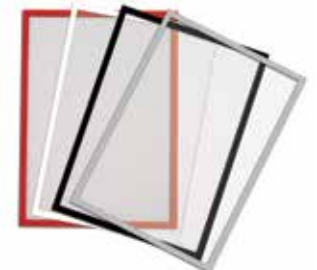

Magnetic Pet Pocket
Please don't forget to order

PET POCKET		
PET POCKET	SIZE	COLOUR
UPCMOR00A4	8.5" X 11"	Red
UPCMB00A4	8.5" X 11"	Black
UPCMOW00A4	8.5" X 11"	White
UPCMOG00A4	8.5" X 11"	Grey
UPCMOG00A5	5.5" X 8.5"	Grey
UPCMB00A5	5.5" X 8.5"	Black

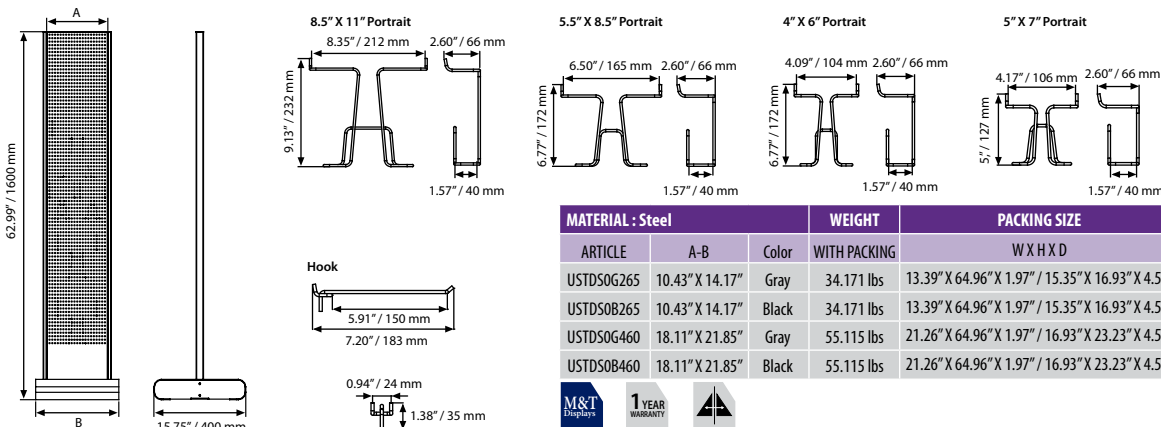

MATERIAL : Steel			WEIGHT	PACKING SIZE
ARTICLE	A-B	Color	WITH PACKING	W X H X D
USTDSOG265	10.43" X 14.17"	Gray	34.171 lbs	13.39" X 64.96" X 1.97" / 15.35" X 16.93" X 4.53"
USTDSOB265	10.43" X 14.17"	Black	34.171 lbs	13.39" X 64.96" X 1.97" / 15.35" X 16.93" X 4.53"
USTDSOG460	18.11" X 21.85"	Gray	55.115 lbs	21.26" X 64.96" X 1.97" / 16.93" X 23.23" X 4.53"
USTDSOB460	18.11" X 21.85"	Black	55.115 lbs	21.26" X 64.96" X 1.97" / 16.93" X 23.23" X 4.53"

SHELF : Steel		
ARTICLE	SIZE	Color
UYPTSG00A4	8.5" X 11"	Gray
UYPTSB00A4	8.5" X 11"	Black
UYPTSG00A5	5.5" X 8.5"	Gray
UYPTSB00A5	5.5" X 8.5"	Black
UYPTSG00A6	5" X 7"	Gray
UYPTSB00A6	5" X 7"	Black
UYPTSG0A43	4" X 6"	Gray
UYPTSB0A43	4" X 6"	Black
UYPTSG0015	5.91"	Gray
UYPTSB0015	5.91"	Black

* W:Width H: Height D: Depth



Basic Reversible Tower Brochure Stand



Double Sided Brochure Stand is suitable for indoor environment. One straight module provides double side option. Only difference from Double sided Tower Stand is that; when a brochure holder is used on one side, it is not possible to hang another one on the opposite side to same holes. Holes on the stand allows personalization of brochure placement and size according to needs. 8.5"x11", 5.5"x8.5", 5"x7", 4"x6", 5.91" brochure holders are available. Quite stable with both its heavy base and design. Smooth lower part of brochure stand allows for branding. Ideal for use at reception areas, educational institutions, travel agencies, hotels, offices, marketing events.

- Product is packed unassembled with an easy to understand instruction sheet for assembly.
- Make your own stand design with desired variation of brochure holder placement and size.
- Brochure holders should be ordered separately.
- 2 packs. See info chart for pack sizes.

Color options



RAL powder coated

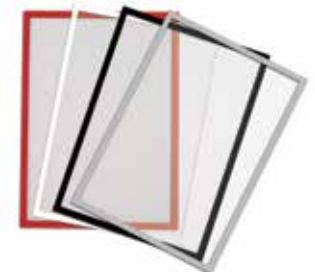

Magnetic Pet Pocket
Please don't forget to order

PET POCKET		
PET POCKET	SIZE	COLOUR
UPCMOR00A4	8.5" X 11"	Red
UPCMOB00A4	8.5" X 11"	Black
UPCMOW00A4	8.5" X 11"	White
UPCMOG00A4	8.5" X 11"	Grey
UPCMOG00A5	5.5" X 8.5"	Grey
UPCMOB00A5	5.5" X 8.5"	Black

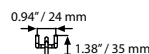
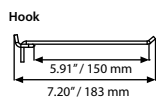
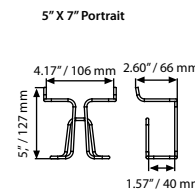
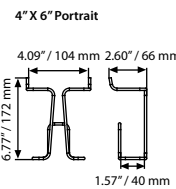
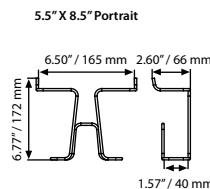
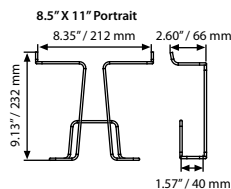
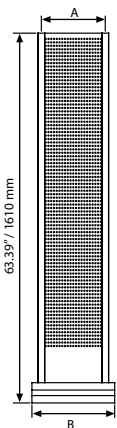

MATERIAL : Steel			WEIGHT		PACKING SIZE	
ARTICLE	A-B	Color	WITH PACKING	W X H X D		
USTBSOG265	10.43" X 14.17"	Gray	28.660 lbs	13.39" X 64.96" X 1.38"	15.35" X 16.93" X 4.53"	
USTBSOB265	10.43" X 14.17"	Black	28.660 lbs	13.39" X 64.96" X 1.38"	15.35" X 16.93" X 4.53"	
USTBSOG460	18.11" X 21.85"	Gray	41.887 lbs	21.26" X 64.96" X 1.38"	16.93" X 23.23" X 4.53"	
USTBSOB460	18.11" X 21.85"	Black	41.887 lbs	21.26" X 64.96" X 1.38"	16.93" X 23.23" X 4.53"	

SHELF : Steel		
ARTICLE	SIZE	Color
UYPTS00A4	8.5" X 11"	Gray
UYPTS00A4	8.5" X 11"	Black
UYPTS00A5	5.5" X 8.5"	Gray
UYPTS00A5	5.5" X 8.5"	Black
UYPTS00A6	5" X 7"	Gray
UYPTS00A6	5" X 7"	Black
UYPTS00A43	4" X 6"	Gray
UYPTS00A43	4" X 6"	Black
UYPTS0015	5.91"	Gray
UYPTS0015	5.91"	Black

* W:Width H: Height D: Depth

Reversible Tower Brochure Stand for Wall

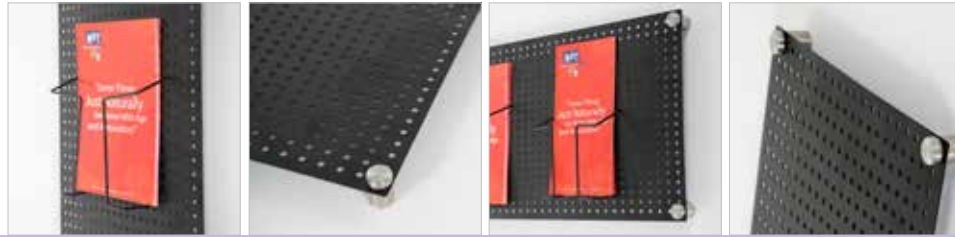

This Single Sided Brochure Stand is suitable for indoor use. One straight module that is hanged on wall provides stable and noticeable brochure placement. Holes on the stand allows personalization of brochure placement and size according to needs. 8.5"x11", 5.5"x8.5", 5"x7", 4"x6", 5.91" brochure holders are available. Ideal for use at reception areas, educational institutions, travel agencies, hotels, offices, marketing events.

Product is packed unassembled with an easy to understand instruction sheet for assembly.

Make your own stand design with desired variation of brochure holder placement and size.

Brochure holders should be ordered separately.

Color options



Silver Black



RAL powder coated

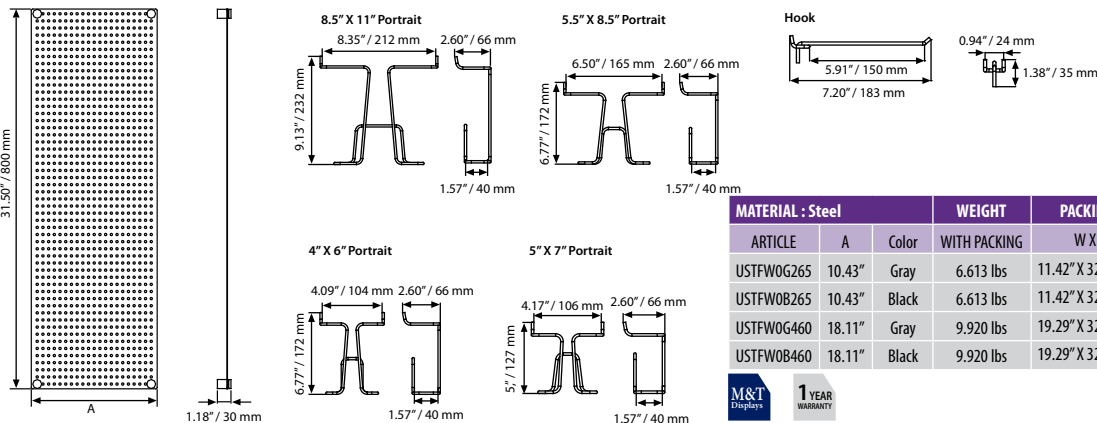

MATERIAL : Steel		WEIGHT		PACKING SIZE	
ARTICLE	A	Color	WITH PACKING	W X H X D	
USTFWOG265	10.43"	Gray	6.613 lbs	11.42" X 32.68" X 1.57"	
USTFWOB265	10.43"	Black	6.613 lbs	11.42" X 32.68" X 1.57"	
USTFWOG460	18.11"	Gray	9.920 lbs	19.29" X 32.68" X 1.57"	
USTFWOB460	18.11"	Black	9.920 lbs	19.29" X 32.68" X 1.57"	

SHELF : Steel		
ARTICLE	SIZE	Color
UYPTS600A4	8.5" X 11"	Gray
UYPTS800A4	8.5" X 11"	Black
UYPTS600A5	5.5" X 8.5"	Gray
UYPTS800A5	5.5" X 8.5"	Black
UYPTS600A6	5" X 7"	Gray
UYPTS800A6	5" X 7"	Black
UYPTS60A43	4" X 6"	Gray
UYPTS80A43	4" X 6"	Black
UYPTS60015	5.91"	Gray
UYPTS80015	5.91"	Black

* W:Width H: Height D: Depth



Reversible Tower Brochure Stand

ARTICLE	CAPACITY				CAPACITY WEIGHT
	8.5"x11" (PCS)	5.5"x8.5" (PCS)	5"x7" (PCS)	4"x6" (PCS)	
USTTC00B265	4	5	12	10	20
USTTC00G265	4	5	12	10	20
USTTC00B460	8	10	18	15	40
USTTC00G460	8	10	18	15	40
USTTW0B265	8	10	24	20	40
USTTW0G265	8	10	24	20	40
USTTW0B460	16	20	36	30	80
USTTW0G460	16	20	36	30	80
USTDS0B265	8	10	24	20	40
USTDS0G265	8	10	24	20	40
USTDS0B460	16	20	36	30	80
USTDS0G460	16	20	36	30	80
USTCU0B265	4	5	12	10	20
USTCU0G265	4	5	12	10	20
USTCU0B460	8	10	18	15	40
USTCU0G460	8	10	18	15	40
USTBS0B265	8	10	24	20	40
USTBS0G265	8	10	24	20	40
USTBS0B460	16	20	36	30	80
USTBS0G460	16	20	36	30	80
USTFW0B265	2	3	8	6	10
USTFW0G265	2	3	8	6	10
USTFW0B460	4	6	12	9	20
USTFW0G265	4	6	12	9	20



8.5"x11" Single sided for 10.43" for 4 pcs
8.5"x11" Single sided for 18.11" for 8 pcs

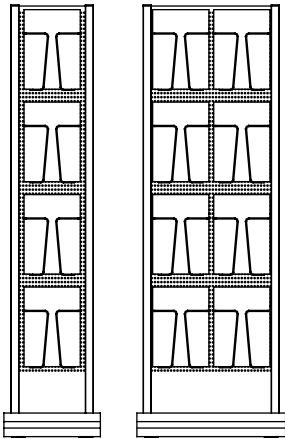

5.5"x8.5" Single sided for 10.43" for 5 pcs
5.5"x8.5" Single sided for 18.11" for 10 pcs

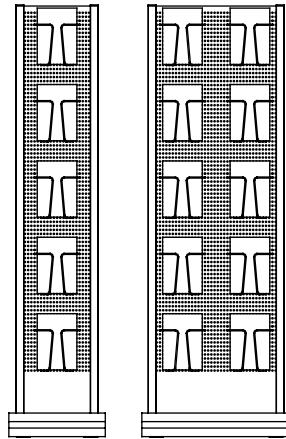

5"x7" Single sided for 10.43" for 12 pcs
5"x7" Single sided for 18.11" for 18 pcs

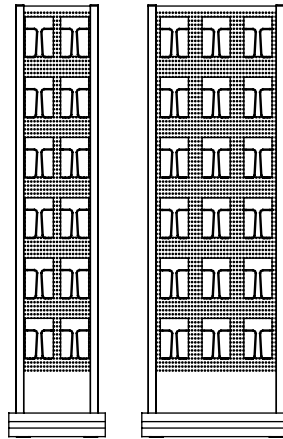

4"x6" Single sided for 10.43" for 10 pcs
4"x6" Single sided for 18.11" for 15 pcs

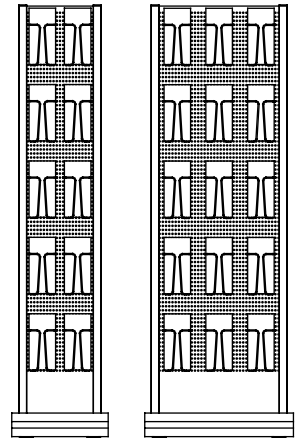

8.5"x11" for wall, 10.43" for 2 pcs
8.5"x11" for wall, 18.11" for 4 pcs

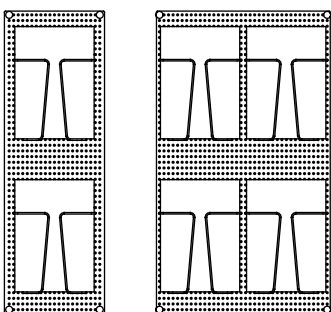

5.5"x8.5" for wall, 10.43" for 3 pcs
5.5"x8.5" for wall, 18.11" for 6 pcs

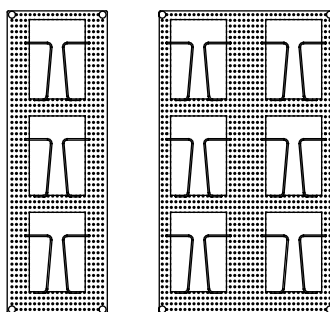

5"x7" for wall, 10.43" for 8 pcs
5"x7" for wall, 18.11" for 12 pcs

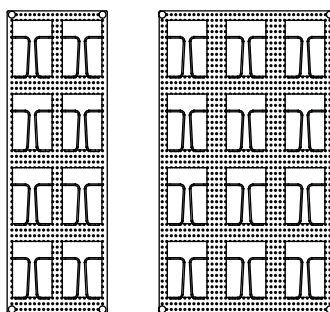

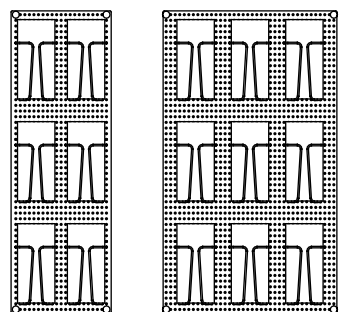

4"x6" for wall, 10.43" for 6 pcs
4"x6" for wall, 18.11" for 9 pcs



Newage Portable Zick-Zack & Portable Zick-Zacks



Restyled Newage Portable Zick-Zack is a foldable unit that provides 5 shelves of 8.5" X 11" capacity. Newage Portable Zick-Zack shelves allow to fold the unit while the brochures are still stored in. The size of the bag: 14.96" x 18.50" x 11.02". It's a handy and smart product for mobile presentations and events.

-  Product is packed assembled, folded in single box.
-  No tool assembly, easy to build-up & ready to use.
-  Lock the top shelf in position for stable display. Bag is provided optional.



Newage Portable Zick-Zack

Portable Zick-Zack

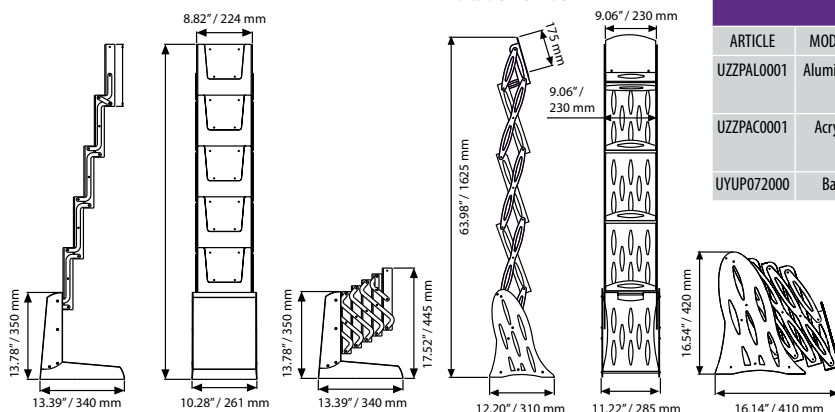

PORTABLE : RAL 9006 powder coated aluminum & clear SHELF: Aluminum & acrylic options

ARTICLE	MODELS	CAPACITY	WEIGHT WITH PACKING	PACKING SIZE *W X H X D	WEIGHT	
					WITH BAG	WITH BAG&PACKING
UZZPAL001	Aluminum	3 X (8.5" X 11")	12.125 lbs	18.90" X 18.90" X 11.81" / 19.29" X 20.08 X 12.20"	16.534 lbs	17.416 lbs
UZZPAC001	Acrylic	3 X (8.5" X 11")	11.023 lbs	18.90" X 18.90" X 11.81" / 19.29" X 20.08 X 12.20"	15.432 lbs	16.314 lbs
UYUP072000	Bag	3 X (8.5" X 11")	5.291 lbs	19.29" X 20.08 X 12.20"	5.291 lbs	

NEWAGE : Clear & Grey RAL 9006			WEIGHT	PACKING SIZE
ARTICLE	SIZE	DESCRIPTION	WITH PACKING	*W X H X D
UZZEPS0100	5 X (8.5" X 11")	with bag	12.125 lbs	12.20" X 20.47" X 16.14"
UZZEPS0000	5 X (8.5" X 11")	without bag	11.023 lbs	12.20" X 20.47" X 16.14"
UYUP072400	5 X (8.5" X 11")	Bag	3.306 lbs	12.20" X 20.47" X 16.14"

*W:Width H: Height D: Depth



Wood Zick-Zack

new

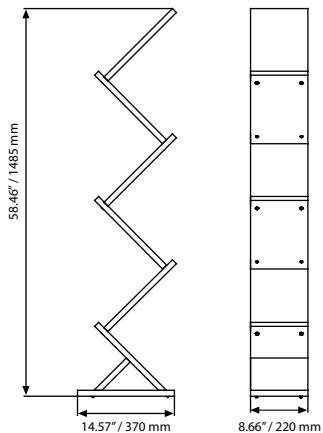
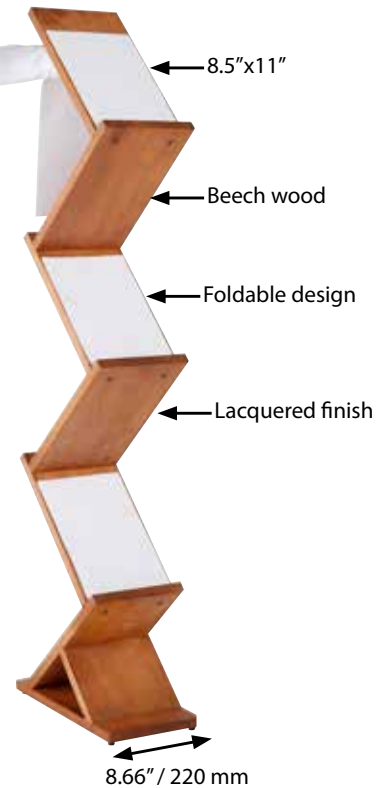
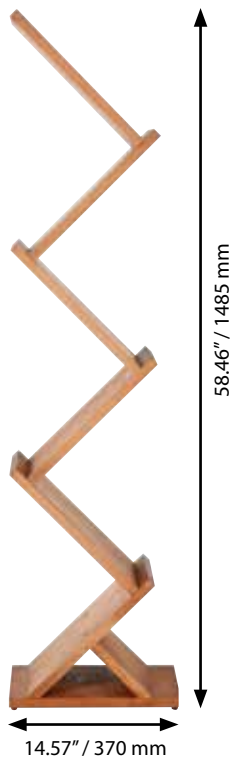

MATERIAL: Beech wood		WEIGHT	PACKING SIZE
ARTICLE	SIZE	WITH PACKING	*W X H X D
UZZWD005A4	5 X (8.5" X 11")		

*W:Width H: Height D: Depth

Monoblocks



An elegant & classic clear stand to display an 8.5" X 11" size paper message on top, a pocket for literature in 8.5" X 11" size. Simple to change the message, eye-catching level of height.

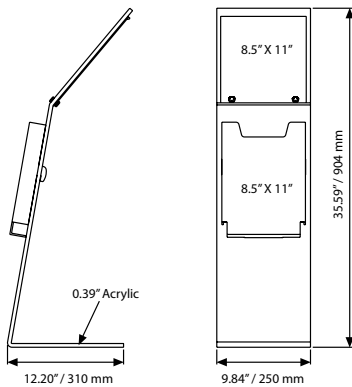
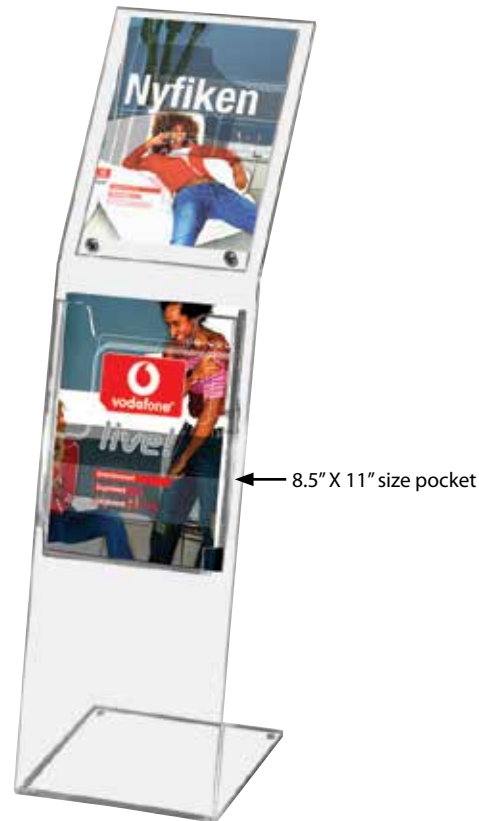

MATERIAL : Acrylic		WEIGHT	PACKING SIZE
ARTICLE	CAPACITY	WITH PACKING	*W X H X D
UMNB001000	8.5" X 11"	10.802 lbs	10.63" X 36.61" X 2.05"



* W:Width H: Height D: Depth



LED Signs

- Convex LEDbox
- Buy Max LEDbox **NEW**
- Best Buy LEDbox
- Smart LEDbox 25 mm
- Smart LEDbox 35 mm
- Weatherproof Smart LEDbox 35 mm
- Lockable Weatherproof Smart LEDbox 35 mm
- Magneco LEDbo
- Magnetic Smart LEDbox
- Acryled for Wall Mounting





Convex Ledbox



Single faced convex boxes are available in various sizes. Access to posters is by snap frame profiles on each long side. The surface is opal acrylic. The snap has a 1" profile. Convex Lightbox includes a PET cover which is ideal to illuminate your duratrans & posters without shining. Best to be with printings on backlit film or duratrans.

 All units pass CE/UL PAT test and are supplied with their quality certificates. Comes along with 98.43" electrical cable. UK and EU plugs should be mentioned on order.

 Illumination save up to 60% energy cost with an increased life expectancy.

 Product is wall mounting, no further hanging accessories are included in the original pack.

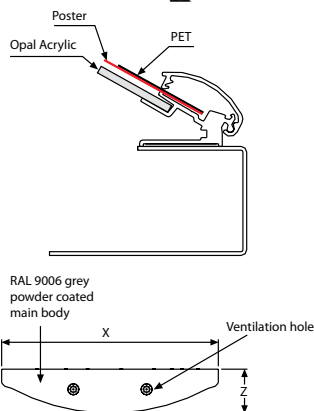
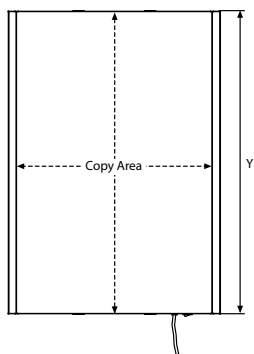

MATERIAL : Silver anodised aluminium					WEIGHT	PACKING SIZE
ARTICLE	EXTERNAL (x-y)	POSTER	COPY	LIGHTING	WITH PACKING	*W X H X D
UCLB25LN23	20.08" X 30.2"	20" X 30"	19.06" X 30"	1800-2200 LUX	17.592 lbs	20.67" X 30.71" X 4.33"
UCLB25LN22	21.93" X 28.15"	22" X 28"	20.98" X 28"	1800-2200 LUX	16.578 lbs	24.02" X 28.74" X 4.92"
UCLB25LN34	29.53" X 40.12"	30" X 40"	29.02" X 40"	2000-2300 LUX	32.650 lbs	30.12" X 40.75" X 5.91"

*W:Width H: Height D: Depth



Buy Max LEDbox Single Sided

new



See movie at our website www.mtdisplays.com.tr

Ultra slim single sided Buy Max LEDbox with 18 mm thickness is an attractive custom sign solution for a wide range of indoor applications. 1" profile Snap Frame makes the change of poster easy. Even illumination is achieved by specially treated acrylic. Illuminated Buy Max LEDbox will capture the attention of passersby easily wherever it is mounted.

- All units pass CE/UL PAT tests and are supplied with their quality certificates. Delivered with 2,5 meter long cable and EU plug. UK and US plugs should be specified with order.
- LED illumination saves up to 60% energy costs (compared to fluorescent technology).
- Has no switch. Complete with built-in power supply, anti-reflex poster cover and wall plugs.
- 1 pack. See info chart for pack sizes.
- No tool assembly is required.

Color options



- Improved Led technology for improved luminance.
- Pre-treated light guided panel diffuses light even & powerful.
- CE listed electrical components.
- 0.71", thickness lightbox we ever sell.
- Offers evenly diffused lux in all sizes.
- Snap - open frame for easy poster change.
- Saves up to 60% energy costs.



2 wall hangers are standard in each product. Moving hangers let the mounting in portrait and landscape position.



Optional dimmer to go with LED illuminated frame. Simply jack the dimmer in frame and then into powersupply. It adjust the light from dark to max lux of LED illuminated frame.

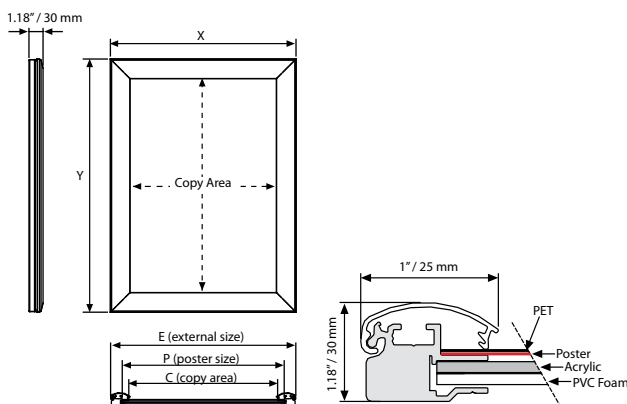

MATERIAL : Silver anodised aluminium PROFILE: 25 MM					WEIGHT	PACKING SIZE
ARTICLE	EXTERNAL (x-y)	POSTER SIZE	COPY	LIGHTING	WITH PACKING	*W X H X D
ULM25TN017	12.20" X 18.19"	11" X 17"	10.20" X 16.18"			
ULM25TN022	23.19" X 29.21"	22" X 28"	21.18" X 27.20"			
ULM25TN023	21.18" X 31.18"	20" X 30"	19.17" X 29.17"	1200-1300 LUX	6.944 lbs	21.85" X 33.86" X 1.38"
ULM25TN024	25.20" X 37.20"	24" X 36"	23.19" X 35.20"			
ULM25TN034	31.18" X 41.18"	30" X 40"	29.17" X 39.17"	1100-1300 LUX	14.219 lbs	31.89" X 43.90" X 1.38"

*W:Width H: Height D: Depth



Best Buy LEDbox Single Sided



See movie at our website www.mtdisplays.com.tr



Very slim single sided Best Buy LEDbox with 0.71" thickness is an ideal choice for wide range of indoor applications. High illumination is achieved by specially treated acrylic and provides a homogenous illumination. Homogenous and brilliant Best Buy LEDbox will get the attention of consumers easily wherever it is mounted.

All units pass CE/UL PAT tests and are supplied with their quality certificates. Delivered with 137.80" inch long cable and US plug. UK and EU plugs should be specified with order.

LED illumination saves up to 60% energy costs (compared to fluorescent technology).

Has no switch and complete with built-in powersupply, antireflex poster cover and wall hangers.

Color options



Silver Black

0.71" / 18 mm depth



1" / 25 mm snap frame



137.80" / 3,5 m cable



2 wall hangers are standard in each product. Moving hangers let the mounting in portrait and landscape position.



Optional dimmer to go with LED illuminated frame.. Simply jack the dimmer in frame and then into powersupply. It adjust the light from dark to max lux of LED illuminated frame.

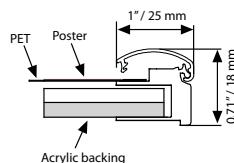
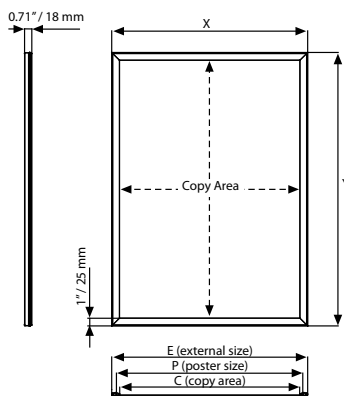

MATERIAL : Silver anodised aluminium PROFILE: 1" / 25 MM					WEIGHT	PACKING SIZE
ARTICLE	EXTERNAL (x-y)	POSTER SIZE	COPY	LIGHTING	WITH PACKING	*W X H X D
ULB25TN017	12.20" X 18.19"	11" X 17"	10.20" X 16.18"	2800-3000 LUX	4.034 lbs	12.80" X 21.06" X 1.38"
ULB25TN022	23.19" X 29.21"	22" X 28"	21.18" X 27.20"	2000-2200 LUX	8.179 lbs	23.82" X 33.27" X 1.38"
ULB25TN023	21.18" X 31.18"	20" X 30"	19.17" X 29.17"	2200-2500 LUX	8.399 lbs	21.85" X 33.86" X 1.38"
ULB25TN024	25.20" X 37.20"	24" X 36"	23.19" X 35.20"	1900-2100 LUX	14.374 lbs	25.79" X 39.96" X 1.38"
ULB25TN034	31.18" X 41.18"	30" X 40"	29.17" X 39.17"	1700-2000 LUX	15.807 lbs	31.89" X 43.90" X 1.38"

*W:Width H:Height D:Depth



Best Buy LEDbox Double Sided



Very slim double sided Best Buy LEDbox with 1.18" thickness is an ideal choice for wide range of indoor applications. High illumination is achieved by specially treated acrylic and provides a homogenous illumination. Homogenous and bright Best Buy LEDbox will get the attention of consumers easily wherever it is mounted.

All units pass CE/UL PAT tests and are supplied with their quality certificates. Delivered with 137.80" long cable and US plug. UK and EU plugs should be specified with order.

LED illumination saves up to 60% energy costs (compared to fluorescent technology).

Complete with 137.80" inch long power supply and suspension kit, but without switch.



Standard hanging kit for all sizes: 78.74" x 2 pcs wire cable and 2 ceiling hangers.



Optional dimmer to go with LED illuminated frame.. Simply jack the dimmer in frame and then into powersupply. It adjust the light from dark to max lux of LED illuminated frame.

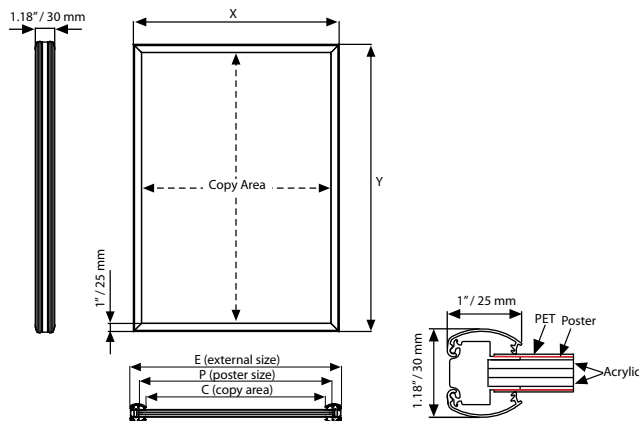

MATERIAL : Silver anodised aluminium PROFILE: 25 MM					WEIGHT	PACKING SIZE
ARTICLE	EXTERNAL (x-y)	POSTER SIZE	COPY	LIGHTING	WITH PACKING	*W X H X D
ULB25CN017	12.20" X 18.19"	11" X 17"	10.20" X 16.18"	2400-2600 LUX	5.180 lbs	12.80" X 21.06" X 1.38"
ULB25CN022	23.19" X 29.21"	22" X 28"	21.18" X 27.20"	1900-2100 LUX	12.698 lbs	23.82" X 33.27" X 1.38"
ULB25CN023	21.18" X 31.18"	20" X 30"	19.17" X 29.17"	2000-2200 LUX	12.456 lbs	21.85" X 33.86" X 1.38"
ULB25CN024	25.20" X 37.20"	24" X 36"	23.19" X 35.20"	1800-2000 LUX	18.783 lbs	25.79" X 39.96" X 1.38"
ULB25CN034	31.18" X 41.18"	30" X 40"	29.17" X 39.17"	1600-1800 LUX	24.647 lbs	31.89" X 43.90" X 1.38"

*W:Width H: Height D: Depth



Smart Ledbox 1" / 25 mm Single Sided



Very slim single sided Smart LEDbox with 0.75" thickness is an ideal choice for wide range of indoor applications. High illumination is achieved by specially treated acrylic and provides a homogenous illumination. The built-in on/off button and outer power supply help long product life. Homogenous and brilliant Smart LEDbox will get the attention of consumers easily wherever it is mounted.

All units pass CE/UL PAT tests and are supplied with their quality certificates. Delivered with 98.43" long cable and US plug. UK and EU plugs should be specified with order.

LED illumination saves up to 60% energy costs (compared to fluorescent technology).

The lightweight SMART LED BOX with slim profile design and low voltage requirements allow mounting at any given point with access to a regular electrical outlet. The unique frame extrusion offers a wide range of mounting or hanging options.

0.75" / 19 mm depth



1" / 25 mm snap frame



2 wall hangers are standard in each product. Moving hangers let the mounting in portrait and landscape position.

- Improved Led technology for improved luminance.
- Pre-treated light guided panel diffuses light even & powerful.
- CE listed electrical components.
- 0.75" thinnest lightbox we ever sell.
- Offers evenly diffused lux in all sizes.
- Snap - open frame for easy poster change.
- Saves up to 60% energy costs.

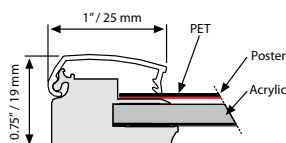
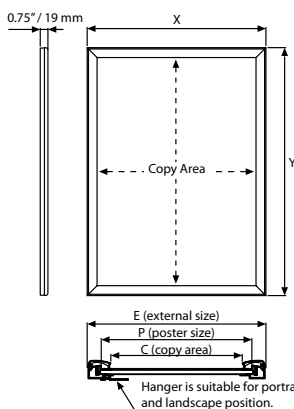

On/off switch button

MATERIAL : Silver anodised aluminium & RAL 9005 powder coated					WEIGHT	PACKING SIZE	
SILVER	BLACK	EXTERNAL (x-y)	POSTER	COPY	LIGHTING	WITH PACKING	*W X H X D
ULD25TN017	ULD25TB017	12.28" X 18.27"	11" X 17"	10.24" X 16.22"	2200-2500 LUX	11.265 lbs	13.19" X 20.87" X 1.81"
ULD25TN018	ULD25TB018	19.29" X 25.28"	18" X 24"	17.24" X 23.23"	2300-2500 LUX	7.936 lbs	19.88" X 27.95" X 1.81"
ULD25TN022	ULD25TB022	23.27" X 29.29"	22" X 28"	21.22" X 27.24"	2400-2700 LUX	9.920 lbs	23.62" X 35.43" X 1.81"
ULD25TN024	ULD25TB024	25.28" X 37.28"	24" X 36"	23.23" X 35.24"	2500-2900 LUX	15.652 lbs	26.18" X 40.16" X 1.81"
ULD25TN034	ULD25TB034	31.26" X 41.26"	30" X 40"	29.21" X 39.21"	2300-2800 LUX	20.392 lbs	31.89" X 43.90" X 1.81"



* W:Width H: Height D: Depth

Smart Ledbox 1" / 25 mm Double Sided



Very slim double sided Smart LEDbox with 1.08" thickness is an ideal choice for wide range of indoor applications. High illumination is achieved by specially treated acrylic and provides a homogenous illumination. The built-in on/off button and outer power supply help long product life. Homogenous and brilliant Smart LEDbox will get the attention of consumers easily wherever it is mounted. The product is equipped with ceiling hangers and cables in portrait position in standard articles.

All units pass CE/UL PAT tests and are supplied with their quality certificates. Delivered with 98.43" long cable and US plug. UK and EU plugs should be specified with order.

LED illumination saves up to 60% energy costs (compared to fluorescent technology).

The lightweight SMART LED BOX with slim profile design and low voltage requirements allow mounting at any given point with access to a regular electrical outlet. The unique frame extrusion offers a wide range of mounting or hanging options.



Standard hanging kit for all sizes: 98.43" x 2 pcs wire cable and 2 ceiling hangers.

- Improved Led technology for improved luminance.
- Pre-treated light guided panel diffuses light even & powerful.
- CE listed electrical components.
- 1.08", thinnest double sided ledbox we ever sell.
- Offers evenly diffused lux in all sizes.
- Snap - open frame for easy poster change.
- Saves up to 60% energy costs.

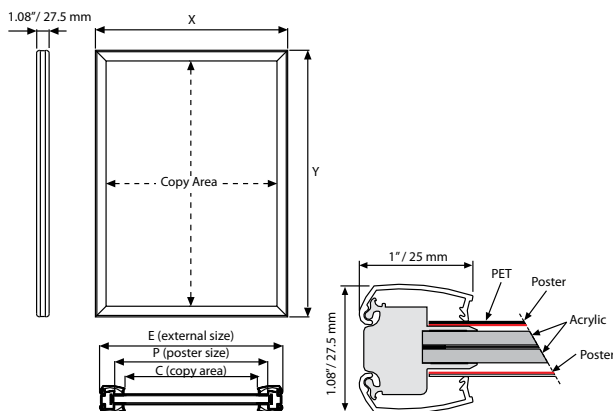

MATERIAL : Silver anodised aluminium & RAL 9005 powder coated						WEIGHT	PACKING SIZE
SILVER	BLACK	EXTERNAL (x-y)	POSTER	COPY	LIGHTING	WITH PACKING	*W X H X D
ULD25CN017	ULD25CB017	12.28" X 18.27"	11" X 17"	10.24" X 16.22"	3000-3300 LUX	11.265 lbs	13.19" X 20.87" X 1.81"
ULD25CN018	ULD25CB018	19.29" X 25.28"	18" X 24"	17.24" X 23.23"	3000-3200 LUX	10.141 lbs	20.08" X 28.54" X 1.81"
ULD25CN022	ULD25CB022	23.27" X 29.29"	22" X 28"	21.22" X 27.24"	2900-3200 LUX	19.202 lbs	24.21" X 31.89" X 1.81"
ULD25CN024	ULD25CB024	25.28" X 37.28"	24" X 36"	23.23" X 35.24"	2700-3000 LUX	20.723 lbs	26.18" X 40.16" X 1.81"
ULD25CN034	ULD25CB034	31.26" X 41.26"	30" X 40"	29.21" X 39.21"	2500-2800 LUX	28.329 lbs	31.89" X 43.90" X 1.81"

*W:Width H: Height D: Depth





Smart Ledbox 1.38" / 35 mm Single Sided



The specially treated acrylic in the middle provides a homogenous lighting. Single Sided Smart Ledboxes are 1.14" in thickness. The article disposes of a built-in on/off switch. These LED light panels are an ideal choice for a wide range of indoor applications. Max. poster size available is 47.24"x95.08" inch. Improved laser treatment to increase lighting efficiency.

 All units pass CE/UL PAT test and comes along with Quality Certificates and with 98.43" electrical cable, UK and EU plugs should be mentioned on order.

 LED illumination save up to 60% energy costs (compared to fluorescent technology) with an increased life expectancy.

 The SMART LED BOX's lightweight, and low voltage allow it to be mounted anywhere there's access to a regular electrical outlet, and the unique frame extrusion offers a wide range of mounting or hanging options.



1.14" / 29 mm depth



1.38" / 35 mm snap frame



On/off switch button

- Improved surface laser treatment for improved luminance
- CE listed electrical components.
- Offers evenly diffused lux in all sizes.
- Saves up to 60% energy costs.



2 wall hangers are standard in each product. Moving hangers let the mounting in portrait and landscape position.

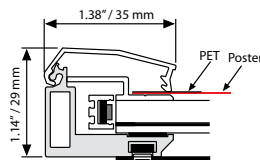
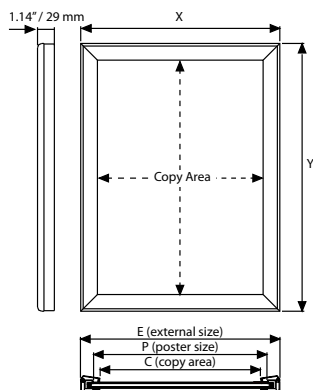

MATERIAL : Silver anodised aluminium					WEIGHT	PACKING SIZE
ARTICLE	EXTERNAL (x-y)	POSTER	COPY	LIGHTING	WITH PACKING	*W X H X D
ULD35TN034	31.85" X 41.85"	30" X 40"	29.09" X 39.09"	2600-2900 LUX	30.137 lbs	34.25" X 48.03" X 2.76"
ULD35TN036	37.87" X 49.88"	36" X 48"	35.12" X 47.13"	2000-2200 LUX	37.037 lbs	40.16" X 55.91" X 2.76"
ULD35TN046	41.85" X 61.85"	40" X 60"	39.09" X 59.09"	2000-2300 LUX	58.069 lbs	44.09" X 68.50" X 2.76"



*W:Width H: Height D: Depth

Smart Ledbox 1.38" / 35 mm Double Sided



The specially treated acrylic in the middle provides a homogenous lighting. Double Sided Smart Ledboxes are 1.54" in thickness. The article disposes of a built-in on/off switch. These LED light panels are an ideal choice for a wide range of indoor applications. Max. poster size available is 40"x63". Improved laser treatment over acrylic to increase lighting efficiency.

All units pass CE/UL PAT test and comes along with Quality Certificates and with 98.43" electrical cable, UK and EU plugs should be mentioned on order.

LED illumination save up to 60% energy costs (compared to fluorescent technology) with an increased life expectancy.

The SMART LED BOX's low voltage requirements allow it to be mounted anywhere there's access to a regular electrical outlet, and the unique frame extrusion offers a wide range of mounting or hanging options.



- Improved surface laser treatment for improved luminance.
- CE listed electrical components.
- Offers evenly diffused lux in all sizes.
- Saves up to 60% energy costs.



Standard hanging kit for all sizes: 98.43" x 2 pcs wire cable and 2 ceiling hangers.

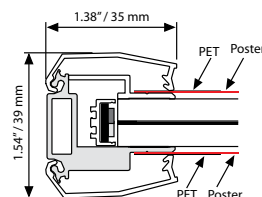
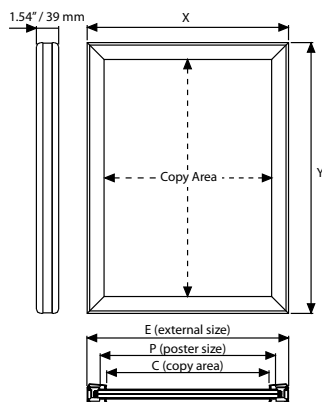

MATERIAL : Silver anodised aluminium					WEIGHT	PACKING SIZE
ARTICLE	EXTERNAL (x-y)	POSTER	COPY	LIGHTING	WITH PACKING	*W X H X D
ULD35CN034	31.85" X 41.85"	30" X 40"	29.09" X 39.09"	2000-2300 LUX	33.069 lbs	35.83" X 46.46" X 2.76"
ULD35CN036	37.87" X 49.88"	36" X 48"	35.12" X 47.13"	2000-2300 LUX	41.909 lbs	40.16" X 55.91" X 2.76"
ULD35CN046	41.85" X 61.85"	40" X 60"	39.09" X 59.09"	1500-1800 LUX	63.603 lbs	46.06" X 66.93" X 2.76"



*W:Width H:Height D:Depth

Weatherproof Smart Ledbox 1.38" / 35 mm Single Sided



The specially treated acrylic in the middle provides a homogenous lighting. Single Sided Smart Ledboxes are 1.18" in thickness. These LED light panels are an ideal choice for a wide range of outdoor applications. Max. poster size available is 40"x75". Improved laser treatment to increase lighting efficiency. Power supply in IP67 standard. Overall product in IP65 standard. Ultimate isolation of water drainage inside LED frame and connection of electrical cable.

All units pass CE/UL PAT test and comes along with Quality Certificates and with 98.43" electrical cable, UK and EU plugs should be mentioned on order.

LED illumination save up to 60% energy costs (compared to flourescent technology) with an increased life expectancy.

The SMART LED BOX's lightweight, low voltage requirements allow it to be mounted anywhere there's access to a regular electrical outlet, and the unique frame extrusion offers a wide range of mounting or hanging options.



- Improved Led technology and laser treatment.
- IP67 and CE listed electrical Components.
- Offers evenly diffused lux in all sizes.



2 wall hangers are standard in each product. Moving hangers let the mounting in portrait and landscape position.



Mobile cable outlet, from the edge and from the back of the aluminum box.



Weatherproof Power Supply (IP67)

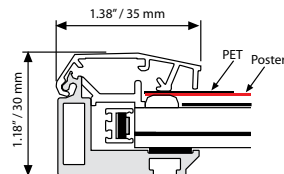
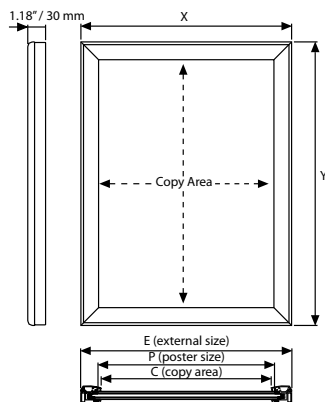
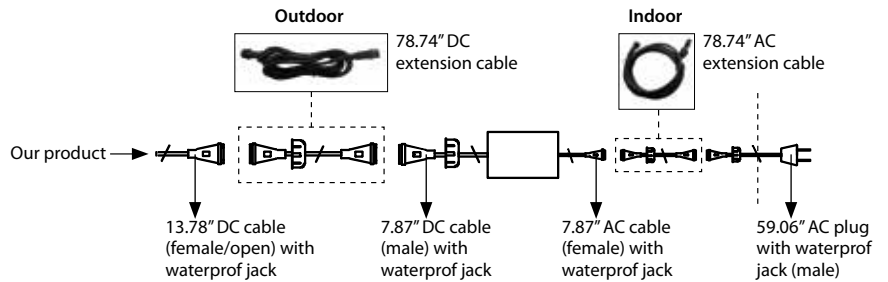

MATERIAL : Silver anodised aluminium					WEIGHT	PACKING SIZE
ARTICLE	EXTERNAL (x-y)	POSTER SIZE	COPY	LIGHTING	WITH PACKING	*W X H X D
ULS35TN022	24.41" X 30.43"	22" X 28"	21.65" X 27.68"	3000-3300 LUX	18.077 lbs	26.38" X 36.42" X 2.76"
ULS35TN024	26.42" X 38.43"	24" X 36"	23.66" X 35.67"	3000-3300 LUX	23.809 lbs	28.35" X 44.29" X 2.76"
ULS35TN034	32.40" X 42.40"	30" X 40"	29.65" X 39.65"	1400-1700 LUX	30.886 lbs	34.25" X 48.03" X 2.76"
ULS35TN046	42.40" X 62.40"	40" X 60"	39.65" X 59.65"	1000-1200 LUX	26.870 lbs	44.09" X 68.50" X 2.76"



* W:Width H: Height D: Depth

Lockable Weatherproof Smart Ledbox 1.38" / 35 mm Single Sided



Lockable weatherproof smart ledbox: Outdoor Smart LEDbox has been improved for using in public places with higher security. Sequentially opening profiles with an allen key keep your poster safe. High and even illumination gets consumer attention to your message.

All units pass CE/UL PAT test and comes along with Quality Certificates and with 98.43" electrical cable, UK and EU plugs should be mentioned on order. Cable length can be extended up to 275.59" by additional cables.

LED illumination save up to 60% energy costs (compared to fluorescent technology) with an increased life expectancy.

The SMART LED BOX'S lightweight, low voltage requirements allow it to be mounted anywhere there's access to a regular electrical outlet, and the unique frame extrusion offers a wide range of mounting or hanging options.



- Improved Led technology and laser treatment.
- IP67 and CE listed electrical Components.
- Offers evenly diffused lux in all sizes.



2 wall hangers are standard in each product. Moving hangers let the mounting in portrait and landscape position.



Mobile cable outlet, from the edge and from the back of the aluminum box.

Weatherproof Power Supply (IP67)

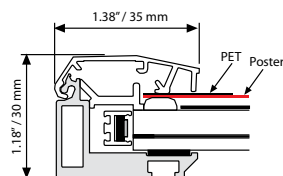
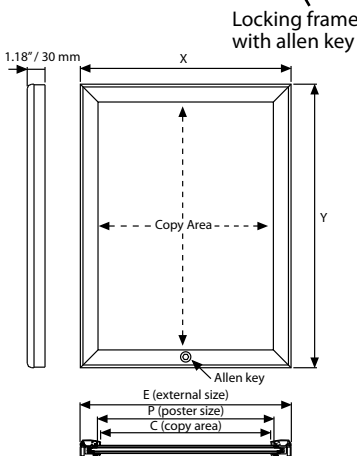
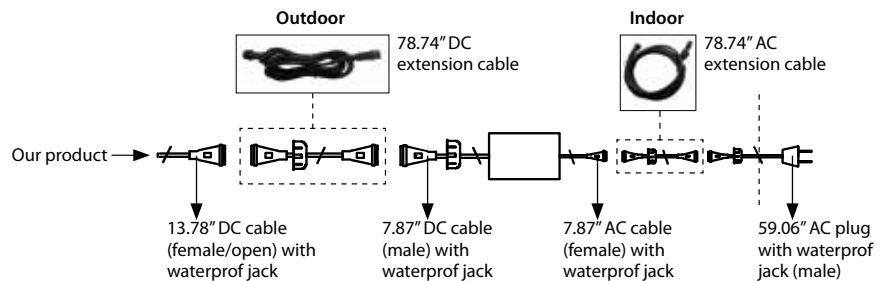

MATERIAL : Silver anodised aluminium					WEIGHT	PACKING SIZE
ARTICLE	EXTERNAL (x-y)	POSTER SIZE	COPY	LIGHTING	WITH PACKING	*W X H X D
ULH35TN022	24.41" X 30.43"	22" X 28"	21.65" X 27.68"	1600-1900 LUX	20.943 lbs	25.98" X 35.83" X 3.15"
ULH35TN024	26.42" X 38.43"	24" X 36"	23.66" X 35.67"	1400-1700 LUX	25.353 lbs	27.95" X 43.90" X 3.15"
ULH35TN034	32.40" X 42.40"	30" X 40"	29.65" X 39.65"	1400-1700 LUX	30.886 lbs	34.25" X 48.43" X 3.15"
ULH35TN046	42.40" X 62.40"	40" X 60"	39.65" X 59.65"	1000-1200 LUX	59.238 lbs	44.09" X 68.90" X 3.15"



*W:Width H: Height D: Depth

Magneco LedBox Single Sided



See movie at our website www.mtdisplays.com.tr



Very Slim, Magneco LEDbox is a new generation in LEDboxes. With a practical magnetic protection cover, it is very easy to change the poster. High and even illumination level attracts consumers to the message. Hidden finger hole to take off the acrylic cover prevents public access to the poster.

All units pass CE/UL PAT tests and are supplied with their quality certificates. Delivered with 137.80" inch long cable and US plug. UK and EU plugs should be specified with order.

LED illumination saves up to 60% energy costs (compared to fluorescent technology).

Complete with 137.80" inch long power supply, wall hangers and acrylic cover. Without switch.

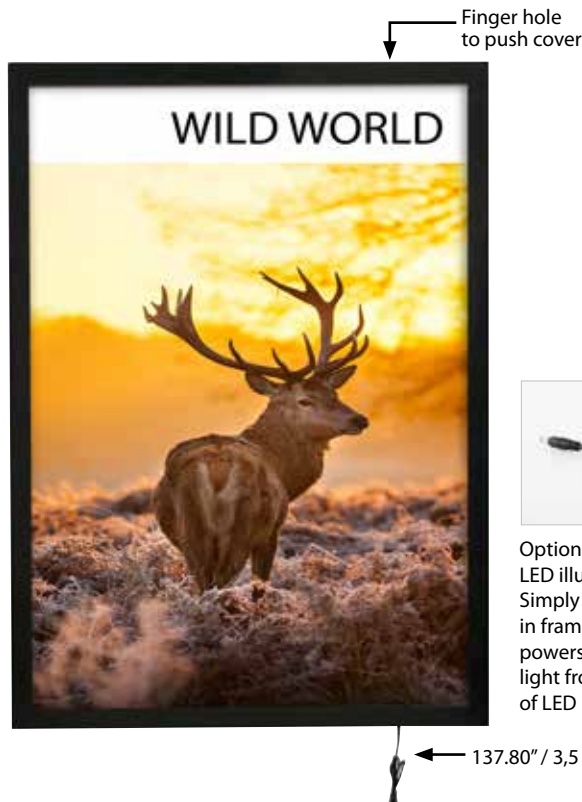

Optional dimmer to go with LED illuminated frame.. Simply jack the dimmer in frame and then into powersupply. It adjust the light from dark to max lux of LED illuminated frame.

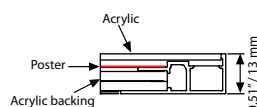
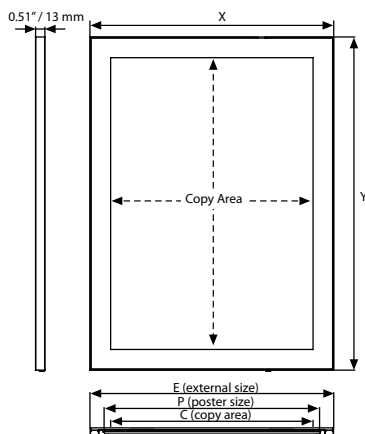

MATERIAL : Silver & black anodised aluminium						WEIGHT	PACKING SIZE
SILVER	BLACK	EXTERNAL (x-y)	POSTER SIZE	COPY	LIGHTING	WITH PACKING	*W X H X D
ULDMEN0B17	ULDMEB0B17	12.60" X 18.58"	11" X 17"	10.31" X 16.30"	2800-3000 LUX	3.769 lbs	13.39" X 21.26" X 1.38"
ULDMEN0B22	ULDMEB0B22	23.58" X 29.61"	22" X 28"	21.30" X 27.32"	2000-2200 LUX	8.620 lbs	24.41" X 32.28" X 1.38"
ULDMEN0B23	ULDMEB0B23	21.57" X 31.57"	20" X 30"	23.23" X 29.29"	2200-2500 LUX	8.686 lbs	22.24" X 34.25" X 1.38"
ULDMEN0B24	ULDMEB0B24	25.59" X 37.60"	24" X 36"	23.31" X 35.31"	1900-2100 LUX	15.873 lbs	26.38" X 40.35" X 1.38"
ULDMEN0B34	ULDMEB0B34	31.57" X 41.57"	30" X 40"	29.41" X 39.29"	1800-2100 LUX	17.350 lbs	32.28" X 44.29" X 1.38"

*W:Width H: Height D: Depth



Magneco LEDbox Double Sided



See movie at our website www.mtdisplays.com.tr



Magneco LEDbox: A new generation in LEDboxes. With a practical magnetic protection cover, it is very easy to change the poster. High illumination level attracts consumers to the message. The lightweight Magneco double sided and low voltage requirements allow mounting at any given point with access to a regular electrical outlet.

All units pass CE/UL PAT tests and are supplied with their quality certificates. Delivered with 137.80" inch long cable and US plug. UK and EU plugs should be specified with order.

LED illumination saves up to 60% energy costs (compared to fluorescent technology).

Complete with 137.80" inch long power supply, wall hangers and acrylic cover. Without switch.



Standard hanging kit for all sizes: 78.74" x 2 pcs wire cable and 2 ceiling hangers.



Optional dimmer to go with LED illuminated frame.. Simply jack the dimmer in frame and then into powersupply. It adjust the light from dark to max lux of LED illuminated frame.

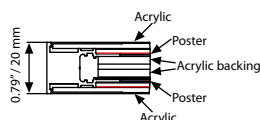
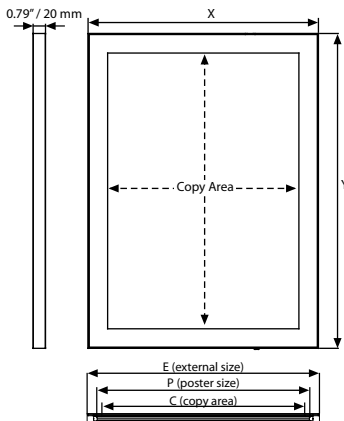

MATERIAL : Silver & black anodised aluminium						WEIGHT	PACKING SIZE
SILVER	BLACK	EXTERNAL (x-y)	POSTER SIZE	COPY	LIGHTING	WITH PACKING	**W X H X D
ULDMENCB17	ULDMEBCB17	12.60" X 18.58"	11" X 17"	10.31" X 16.30"	2400-2600 LUX	6.459 lbs	13.39" X 21.26" X 1.38"
ULDMENCB22	ULDMEBCB22	23.58" X 29.61"	22" X 28"	21.30" X 27.32"	1900-2100 LUX	15.278 lbs	24.41" X 32.28" X 1.38"
ULDMENCB23	ULDMEBCB23	21.57" X 31.57"	20" X 30"	23.23" X 29.29"	2000-2200 LUX	15.101 lbs	22.24" X 34.25" X 1.38"
ULDMENCB24	ULDMEBCB24	25.59" X 37.60"	24" X 36"	23.31" X 35.31"	1800-2000 LUX	22.068 lbs	26.38" X 40.35" X 1.38"
ULDMENCB34	ULDMEBCB34	31.57" X 41.57"	30" X 40"	29.41" X 39.29"	1600-1800 LUX	29.982 lbs	32.28" X 44.29" X 1.38"

*W:Width H: Height D: Depth



Magnetic Smart Ledbox



See movie at our website www.mtdisplays.com.tr



Magnetic Smart LEDbox: A new generation in LEDboxes. With a practical magnetic protection cover, it is very easy to change the poster. High illumination level attracts consumers to the message.

All units pass CE/UL PAT test and comes along with Quality Certificates and with 98.43" electrical cable, UK and EU plugs should be mentioned on order.

LED illumination save up to 60% energy costs (compared to fluorescent technology) with an increased life expectancy.

Please use the built in cover lever bottom next to on/off switch button.



0.94" / 24 mm depth



On/off switch button

Clear clips to hold the poster

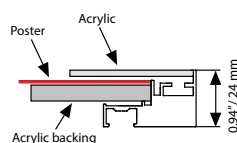
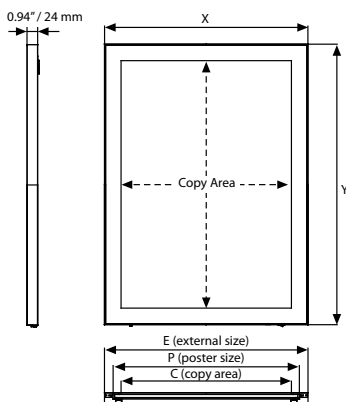

MATERIAL : Silver anodised aluminium						WEIGHT	PACKING SIZE
SILVER	BLACK	EXTERNAL (x-y)	POSTER	COPY	LIGHTING	WITH PACKING	*W X H X D
ULDMON0018	ULDMOB0018	19.61" X 25.59"	18" X 24"	17.05" X 23.03"	3300-3500	9.920 lbs	20.47" X 29.92" X 1.57"
ULDMON0023	ULDMOB0023	21.57" X 31.57"	20" X 30"	19.02" X 29.02"	3200-3500	12.125 lbs	22.44" X 35.83" X 1.57"
ULDMON0022	ULDMOB0022	23.58" X 29.61"	22" X 28"	21.02" X 27.05"	3200-3500	12.125 lbs	24.80" X 34.45" X 1.57"
ULDMON0024	ULDMOB0024	25.59" X 37.60"	24" X 36"	23.03" X 35.04"	3200-3500	15.432 lbs	26.77" X 42.52" X 1.57"
ULDMON0034	ULDMOB0034	31.57" X 41.57"	30" X 40"	29.02" X 39.02"	3000-3200	20.943 lbs	32.28" X 45.87" X 1.57"

*W:Width H: Height D: Depth



AcryLed for Wall Mounting



See movie at our website www.mtdisplays.com.tr



Ultra slim and clear AcryLed. The edge-lit acrylic mounts portrait or landscape for various types of signage. AcryLed lit with LEDs use less power than traditional with light signage. Poster is placed in between the specially treated acrylic & cover acrylic sheet & fixed in position by two clear clips on two short sides. Products is available in 2 colours; silver and black. Compared to traditional articles in the market, AcryLed provides easy poster change when unit keeps mounted on the wall.

All units pass CE/UL PAT test and are supplied with their quality certificates. Comes along with 98.43" electrical cable. UK and EU plugs should be mentioned on order.

Illumination save up to 60% energy cost with an increased life expectancy.

AcryLed's lightweight and low voltage requirements allow it to be mounted anywhere there's access to regular electrical outlet.

Color options

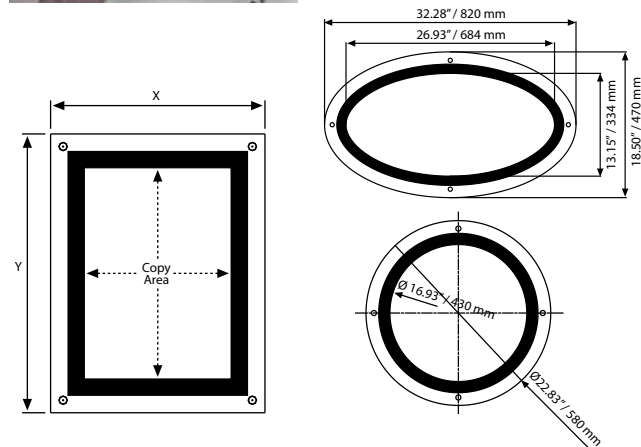

MATERIAL : Treated illuminated acrylic					WEIGHT	PACKING SIZE
ARTICLE	EXTERNAL (x-y)	POSTER	COPY	DESCRIPTION	WITH PACKING	*W X H X D
UACLON0081	12.95" X 15.47"	8.5" X 11"	7.87" X 10.39"	Square - Silver	4.850 lbs	14.17" X 19.69" X 2.76"
UACLON0017	15.47" X 21.46"	11" X 17"	10.39" X 16.38"	Square - Silver	7.716 lbs	17.72" X 24.41" X 2.76"
UACLOB0081	12.95" X 15.47"	8.5" X 11"	7.87" X 10.39"	Square - Black	4.850 lbs	14.17" X 19.69" X 2.76"
UACLOB0017	15.47" X 21.46"	11" X 17"	10.39" X 16.38"	Square - Black	7.716 lbs	17.72" X 24.41" X 2.76"
UACLNO0000	Ø 22.83"	Ø 17.56"	Ø 16.93"	Circle - Silver	12.125 lbs	24.80" X 27.56" X 2.95"
UACLNO0000	Ø 22.83"	Ø 17.56"	Ø 16.93"	Circle - Black	12.125 lbs	24.80" X 27.56" X 2.95"
UACLENO0000	32.28" X 18.50"	27.56" X 13.78"	26.93" X 13.15"	Elliptical - Silver	14.330 lbs	20.47" X 36.61" X 2.95"
UACLEBO0000	32.28" X 18.50"	27.56" X 13.78"	26.93" X 13.15"	Elliptical - Black	14.330 lbs	20.47" X 36.61" X 2.95"



*W:Width H: Height D: Depth

Smart LEDbox LED Product Programme (Production & Availability)

Size Available	25mm Indoor LEDbox		35mm Indoor LEDbox		35mm Outdoor/ Lockable LEDbox	Best Buy LEDbox		Magneco LEDbox		Magnetic LEDbox	Convex LEDbox	AcryLED	Buy Max LEDbox
	single	double	single	double	single	single	double	single	double	single	single	single	single
Poster Size	single	double	single	double	single	single	double	single	double	single	single	single	single
81 - 8,5" x 11"	X	X	X	X	X	X	X	X	X	X	X	X	X
17 - 11" x 17"	ULD25TN017	ULD25CN017	ULD35TN017	ULD35CN017	ULS35TN017	ULB25TN017	ULB25CN017	ULDMEN0B17	ULDMENCB17	ULDMON0017	UCLB25LN17	UACLON0017	ULM25TN017
18 - 18" x 24"	ULD25TN018	ULD25CN018	X	X	X	X	X	X	X	X	X	UACLON0018	ULM25TN018
22 - 22" x 28"	ULD25TN022	ULD25CN022	ULD35TN022	ULD35TN022	ULS35TN022	ULB25TN022	ULB25CN022	ULDMEN0B22	ULDMENCB22	ULDMON0022	UCLB25LN22	UACLON0022	ULM25TN022
23 - 20" x 30"	ULD25TN023	ULD25CN023	ULD35TN023	ULD35TN023	ULS35TN023	ULB25TN023	ULB25CN023	ULDMEN0B23	ULDMENCB23	ULDMON0023	UCLB25LN23	UACLON0023	ULM25TN023
24 - 24" x 36"	ULD25TN024	X	ULD35TN024	ULD35TN024	ULS35TN024	ULB25TN024	ULB25CN024	ULDMEN0B24	ULDMENCB24	ULDMON0024	X	UACLON0024	ULM25TN024
34 - 30" x 40"	ULD25TN034	X	ULD35TN034	ULD35CN034	ULS35TN034	ULB25TN034	ULB25CN034	ULDMEN0B34	ULDMENCB34	ULDMON0034	UCLB25LN34	UACLON0034	ULM25TN034
36 - 36" x 48"	X	X	X	X	X	X	X	X	X	X	X	X	X
46 - 40" x 60"	X	X	ULD35TN046	ULD35CN046	ULS35TN046	X	X	X	X	X	X	X	X
Max(w x h) inch	33.46" x 47.24"	23.62" x 35.43"	47.24" x 95"	40" x 63"	47.24" x 82.67"	33.46" x 78.74"	33.46" x 78.74"	33.46" x 47.24"	33.46" x 47.24"	33.46" x 47.24"	33.46" x 49.21"	33.46" x 47.24"	27.56" x 39.37"

*Max perimeter is 157.48" in condition of short profile is max 33.46" and long profile is max 59.06".

Power Consumption	25mm Indoor LEDbox		35mm Indoor LEDbox		35mm Outdoor/ Lockable LEDbox	Best Buy LEDbox		Magneco LEDbox		Magnetic LEDbox	Convex LEDbox	AcryLED	Buy Max LEDbox
	single	double	single	double	single	single	double	single	double	single	single	single	single
Poster Size	single	double	single	double	single	single	double	single	double	single	single	single	single
81 - 8,5" x 11"	X	X	X	X	X	X	X	X	X	X	X	X	X
17 - 11" x 17"	18W / 1,44A	18W / 1,5A	18W / 1,44A	26W / 2,16A	18W / 1,44A	10W / 0,84A	16,6W / 1,22A	10W / 0,84A	16,6W / 1,22A	18W/1,44A	6,4W / 0,53A	18W / 1,44A	18W / 1,44A
18 - 18" x 24"	20W / 1,6A	23W / 1,92	X	X	X	X	X	X	X	X	X	27W / 2,24A	27W / 2,24A
22 - 22" x 28"	27W / 2,24A	28W / 2,33A	27W / 2,24A	41W / 3,33A	27W / 2,24A	17,6W / 1,5A	24W / 2A	17,6W / 1,5A	24W / 2A	27W/2,24A	13,2W / 1,1A	31W / 2,56A	31W / 2,56A
23 - 20" x 30"	31W / 2,56A	32W / 2,66A	31W / 2,56A	46W / 3,83A	31W / 2,56A	17W / 1,41A	26W / 2,16A	17W / 1,41A	26W / 2,16A	31W/2,56A	19,3W / 1,6A	41W / 3,33A	41W / 3,33A
24 - 24" x 36"	38W / 3,16A	X	41W / 3,33A	61W / 5A	41W / 3,33A	22,5W / 1,9A	31W / 2,6A	22,5W / 1,9A	31W / 2,6A	41W/3,33A	30W / 2,6A	41W / 3,36A	41W / 3,36A
34 - 30" x 40"	41W / 3,36A	X	41W / 3,36A	62W / 5A	41W / 3,36A	25W / 2,08A	36W / 3,02A	25W / 2,08A	36W / 3,02A	41W/3,36A	26,5W / 2,2A	41W / 3,36A	41W / 3,36A
36 - 36" x 48"	X	X	X	X	X	X	X	X	X	X	X	X	X
46 - 40" x 60"	X	X	60W / 5A	94W / 7,5A	60W / 5A	X	X	X	X	X	X	X	X

Power Supply Recommended (12 Vdc, Ampere)	25mm Indoor LEDbox		35mm Indoor LEDbox		35mm Outdoor/ Lockable LEDbox	Best Buy LEDbox		Magneco LEDbox		Magnetic LEDbox	Convex LEDbox	AcryLED	Buy Max LEDbox
	single	double	single	double	single	single	double	single	double	single	single	single	single
Poster Size	single	double	single	double	single	single	double	single	double	single	single	single	single
81 - 8,5" x 11"	X	X	X	X	X	X	X	X	X	X	X	X	X
17 - 11" x 17"	2A	2A	2A	3A	2A	2A	2A	2A	2A	2A	1A	2A	2A
18 - 18" x 24"	2A	3A	X	X	X	X	X	X	X	X	X	3A	3A
22 - 22" x 28"	3A	3A	3A	4A	3A	2A	3A	2A	3A	3A	2A	3A	3A
23 - 20" x 30"	3A	3A	3A	5A	3A	2A	3A	2A	3A	3A	2A	4A	4A
24 - 24" x 36"	4A	X	4A	6A	4A	3A	3A	3A	3A	4A	3A	4A	4A
34 - 30" x 40"	4A	X	4A	6A	4A	3A	4A	3A	4A	4A	3A	4A	4A
36 - 36" x 48"	X	X	X	X	X	X	X	X	X	X	X	X	X
46 - 40" x 60"	X	X	6A	9A	6A	X	X	X	X	X	X	X	X

LUX	25mm Indoor LEDbox		35mm Indoor LEDbox		35mm Outdoor/ Lockable LEDbox	Best Buy LEDbox		Magneco LEDbox		Magnetic LEDbox	Convex LEDbox	AcryLED	Buy Max LEDbox
	single	double	single	double	single	single	double	single	double	single	single	single	single
Poster Size	single	double	single	double	single	single	double	single	double	single	single	single	single
81 - 8,5" x 11"	X	X	X	X	X	X	X	X	X	X	X	X	X
17 - 11" x 17"	1700-1200	1500-1800	3900-4200	2200-2500	2700-3000	2800-3000	2400-2600	2800-3000	2400-2600	5500-6000	2800-3300	2400-2600	2400-2600
18 - 18" x 24"	2500-2800	1800-2100	X	X	X	X	X	X	X	X	X	2200-2400	2200-2400
22 - 22" x 28"	3300-3600	2000-2300	3000-3300	2300-2700	1800-2100	2000-2200	1900-2100	2000-2200	1900-2100	5000-5400	2500-3000	2100-2300	2100-2300
23 - 20" x 30"	2900-3200	1700-1900	3000-3300	2100-2400	1600-1900	2200-2500	2000-2200	2200-2500	2000-2200	3500-3800	1800-2200	2000-2200	2000-2200
24 - 24" x 36"	3000-3300	X	2000-2300	2100-2400	1600-1900	1900-2100	1800-2000	1900-2100	1800-2000	4600-4900	2000-2300	1800-2200	1800-2200
34 - 30" x 40"	2500-2800	X	2600-2900	2000-2300	1400-1700	1700-2000	1600-1800	1800-2100	1600-1800	2800-3200	2000-2300	2100-2600	2100-2600
36 - 36" x 48"	X	X	X	X	X	X	X	X	X	X	X	X	X
46 - 40" x 60"	X	X	2000-2300	1500-1800	1000-2000	X	X	X	X	X	X	X	X

- ✓ Standard colour: Silver Anodised
- ✓ Available in RAL colours (subject to MOQ)
- ✓ Power supply is provided with the unit to suit each of the product
- ✓ Luminance: 2000-3000 lux (depending on size)
- ✓ Standard Packaging: Single units in polybag and box
- ✓ Low power consumption (see above average power consumption table for each size)
- ✓ Various plugs available such as European, UK, US and Australian
- ✓ Complies with EN55015 & EN61547.

POWER SUPPLY	
ARTICLE	DESCRIPTION
UYPLD00010	Power supply EU 3,34A 7/24
UYPLD00011	Power supply EU 6,67A 7/24
UYPLD00012	Power supply EU 8,5A 7/24
UYPLD00013	Power supply EU 11,5A 7/24

- ✓ Products are suitable to use 7/16.
- ✓ If 7/24 use required, please order individually as 7/24 power supplies as below:



In case of any claim, user is required to return product or any parts to manufacturer for analyses at their cost. As long as the manufacturer confirms the problem is a manufacturing fault, the replacement can be provided. This applies for all illuminated products.



Message Boards

- Frameboards
- Write-on Boards
- Magnetic Glass Board
- Enclosed Bulletin Boards
 - Office Boards
 - Universal Showboard Cork
 - Showboards
- Premium Grade Enclosed Bulletin Boards
 - Noticeboards
 - Noticeboards With Led Light
 - Noticeboards With Logo



Frameboard 0.35" / 9 mm



The frame board has a 3 different models; with cork backing, with a dry-wipe magnetic surface, with a cork&perforated steel backing. 4x(8.5"x11"), 6x(8.5"x11"), 9x(8.5"x11") and 12x(8.5"x11") paper capacity sizes are available and can be used both in portrait & landscape positions. Each unit includes a free set of pins & magnets. It is practical for use at offices, hospitals, home, school etc.

Each frame includes a set of pins. Each frame is packed individual in carton box.

Easy to move hangers facilitate assembly.

Size of boards for all Frameboard models:

	6x(8.5"x11")		9x(8.5"x11")			12x(8.5"x11")			
4x(8.5"x11")	(8.5"x11")	(8.5"x11")	(8.5"x11")	(8.5"x11")	(8.5"x11")	(8.5"x11")	(8.5"x11")	(8.5"x11")	(8.5"x11")
(8.5"x11")	(8.5"x11")	(8.5"x11")	(8.5"x11")	(8.5"x11")	(8.5"x11")	(8.5"x11")	(8.5"x11")	(8.5"x11")	(8.5"x11")
(8.5"x11")	(8.5"x11")	(8.5"x11")	(8.5"x11")	(8.5"x11")	(8.5"x11")	(8.5"x11")	(8.5"x11")	(8.5"x11")	(8.5"x11")

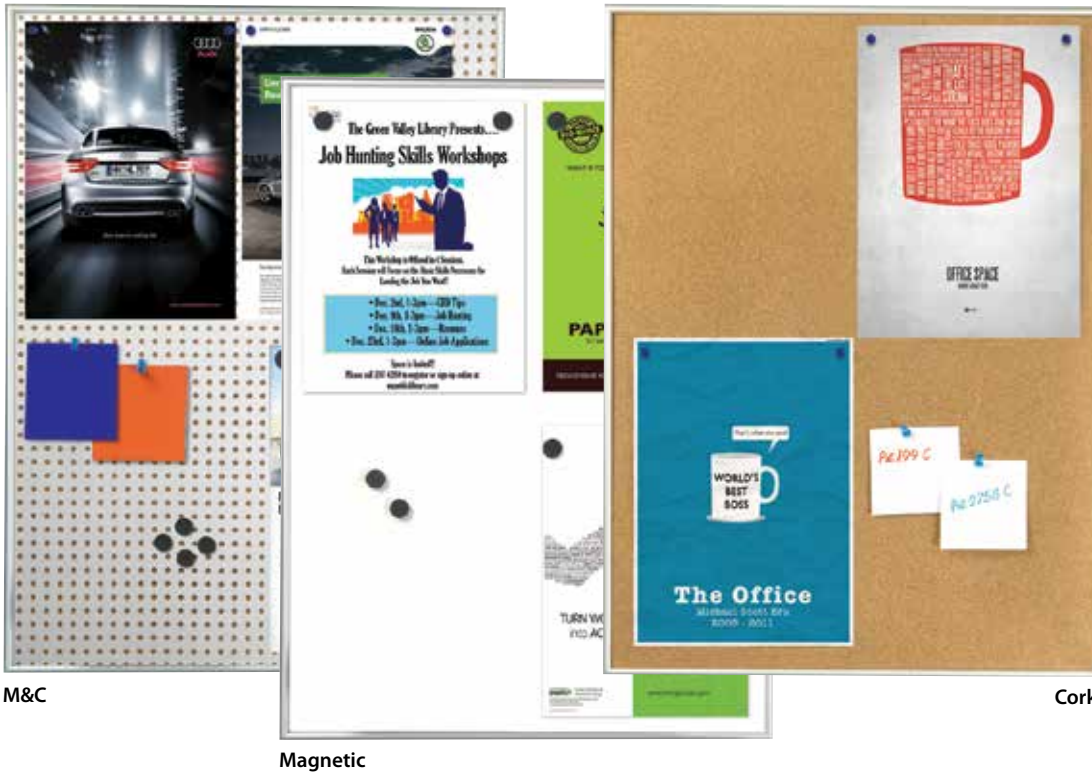
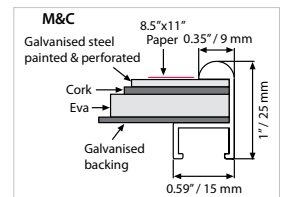
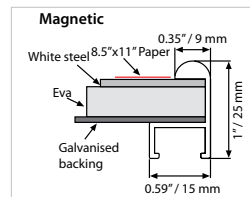
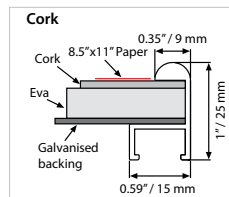
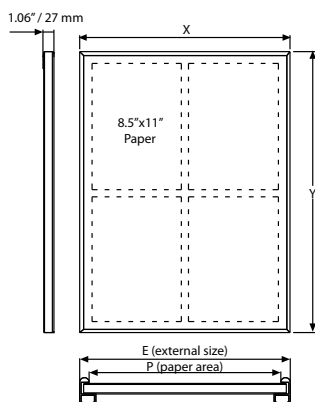

Photo of the hanger



MATERIAL : Silver anodised aluminium						WEIGHT WITH PACKING			PACKING SIZE
CORK	MAGNETIC	M&C	EXTERNAL (x-y)	PAPER AREA	CAPACITY	CORK	MAGNETIC	M&C	*W X H X D
U1CB95N144	U2CB95N144	U3CB95N144	19.88" X 26.57"	19.17" X 25.87"	4 X (8.5" X 11")	6.503 lbs	9.546 lbs	9.700 lbs	20.47" X 27.56" X 1.38"
U1CB95N164	U2CB95N164	U3CB95N164	19.88" X 39.17"	19.17" X 38.46"	6 X (8.5" X 11")	9.490 lbs	13.845 lbs	13.348 lbs	20.47" X 39.76" X 1.38"
U1CB95N194	U2CB95N194	U3CB95N194	28.94" X 39.17"	28.23" X 38.46"	9 X (8.5" X 11")	14.065 lbs	18.651 lbs	18.441 lbs	29.13" X 39.76" X 1.38"
U1CB95N114	U2CB95N114	U3CB95N114	37.99" X 39.17"	37.28" X 38.46"	12 X (8.5" X 11")	18.662 lbs	25.353 lbs	23.909 lbs	38.58" X 39.76" X 1.38"



*W:Width H: Height D: Depth

Write-on Board



Write-on board has both silver and black colour models, allowing white dry-wipe surface suitable for boardmarkers and waterbase chalkpens. It's a light, affordable board suiting the needs of offices, schools, presentation rooms & various commercial environments. Both colours are available in 4 different sizes. Aluminium Write-on Board is stylish and durable.

 Each unit is packed individual in carton box. Each board includes V hanger and adhesive tape at the back side as mounting set.

 Landscape/portrait wall mounting.

 Accessories (rubber & marker) are not included in the original box. Please clean the surface before applying the double sided tape for better application.



2xV hangers in each box.



Chalkboard Marker
UYKLM1251 - Colour Marker
UYKLM1250 - White Marker

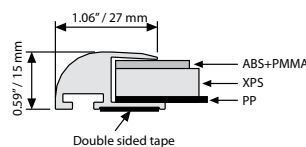
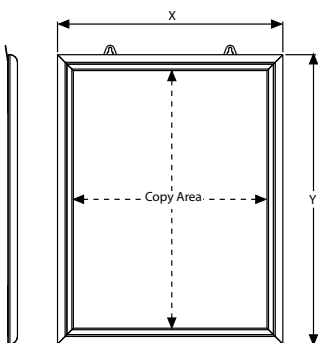

MATERIAL : Silver anodised aluminium				WEIGHT	PACKING SIZE
ARTICLE	EXTERNAL (x-y)	COPY AREA	DESCRIPTION	WITH PACKING	*W X H X D
UWBONW0012	13.90" X 17.83"	16" X 22"	Silver-White	3.52 lbs	20.08" X 25.98" X 1.22"
UWBONW0018	17.83" X 25.71"	18" X 24"	Silver-White	3.52 lbs	22.05" X 27.95" X 1.22"
UWBONW0022	25.71" X 33.58"	22" X 28"	Silver-White	5.39 lbs	25.98" X 31.89" X 1.22"
UWB0BB0012	13.90" X 17.83"	16" X 22"	Black-Black	3.52 lbs	20.08" X 25.98" X 1.22"
UWB0BB0018	17.83" X 25.71"	18" X 24"	Black-Black	3.52 lbs	22.05" X 27.95" X 1.22"
UWB0BB0022	25.71" X 33.58"	22" X 28"	Black-Black	5.39 lbs	25.98" X 31.89" X 1.22"



*W:Width H: Height D: Depth

Office Boards



Suitable for indoor use. It has 2 different backing models. Each unit includes a free set of pins or magnets. Single key 4x(8.5"x11"), double key 6x(8.5"x11"), 9x(8.5"x11") and 12x(8.5"x11") sizes are available and can be used both in portrait & landscape positions. The cover can be opened to 90 degrees. Each unit includes mounting screw and plugs for easy wall mounting. The depth of the case is 1.38".

Each product includes 1 key set of singlevariation.

Please discard the protective film on the unit before use.



Cork



Magnetic

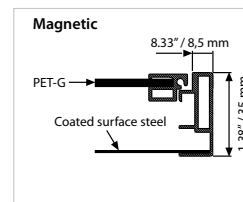
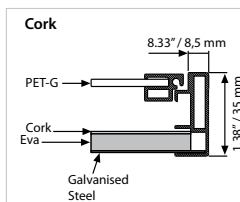
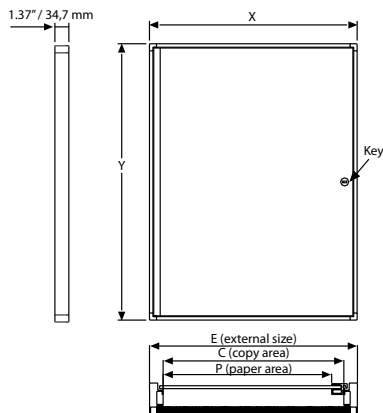

MATERIAL : Silver anodised aluminium							WEIGHT WITH PACKING		PACKING SIZE
CORK	MAGNETIC	EXTERNAL (x-y)	COPY	PAPER AREA	CAPACITY	KEY	MAGNETIC	CORK	*W X H X D
USBN4004A4	USBN5004A4	20.28" X 26.97"	18.66" X 25.87"	19.17" X 25.87"	4 X (8.5" X 11")	2	9.964 lbs	9.479 lbs	21.46" X 28.15" X 2.36"
USBN4006A4	USBN5006A4	20.28" X 39.57"	18.66" X 38.46"	19.17" X 38.46"	6 X (8.5" X 11")	2	15.319 lbs	15.167 lbs	21.46" X 40.75" X 2.36"
USBN4009A4	USBN5009A4	29.33" X 39.57"	27.72" X 38.46"	28.23" X 38.46"	9 X (8.5" X 11")	2	19.114 lbs	20.348 lbs	30.31" X 40.75" X 2.36"





* W:Width H: Height D: Depth

Universal Showboard with Cork & Magnetic



Universal Showboard has 2 models; one with a cork backing and with a magnetic backing. It has a slim case which is 1.06" deep and 1.18" profile and hidden lock on the side. It is suitable for public places or outdoor use under a shelter.

-  Each product includes 1 key set of single variation.
-  Each unit is supplied with a free set of clear plastic pegs to hold the poster. 2 stays at each end help to keep the cover door open.
-  Please discard the protective film on the unit before use.

1.06" / 27 mm thickness



Magnetic



Cork

Discreet door lock

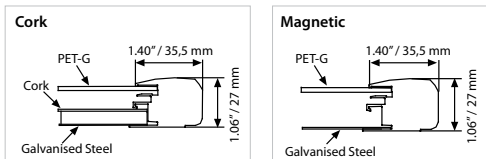

Size of boards for all Universal Showboard models:

4x(8.5"x11")		6x(8.5"x11")		9x(8.5"x11")	
(8.5"x11")	(8.5"x11")	(8.5"x11")	(8.5"x11")	(8.5"x11")	(8.5"x11")
(8.5"x11")	(8.5"x11")	(8.5"x11")	(8.5"x11")	(8.5"x11")	(8.5"x11")
(8.5"x11")	(8.5"x11")	(8.5"x11")	(8.5"x11")	(8.5"x11")	(8.5"x11")

MATERIAL : Silver anodised aluminium							WEIGHT	PACKING SIZE
CORK	MAGNETIC	EXTERNAL (x-y)	COPY	PAPER AREA	CAPACITY	KEY	WITH PACKING	*W X H X D
USBNU104A4	USBNU204A4	22.05" X 28.74"	19.25" X 25.94"	19.13" X 25.83"	4 X (8.5" X 11")	1	14.330 lbs	22.83" X 30.31" X 1.81"
USBNU106A4	USBNU206A4	22.05" X 41.34"	19.25" X 38.54"	19.13" X 38.43"	6 X (8.5" X 11")	2	18.518 lbs	22.83" X 42.91" X 1.81"
USBNU109A4	USBNU209A4	31.10" X 41.34"	28.31" X 38.54"	28.19" X 38.43"	9 X (8.5" X 11")	2	24.691 lbs	31.89" X 42.91" X 1.81"



*W:Width H: Height D: Depth

Showboards



Suitable for outdoor use. It has 3 model; with a cork backing, with a magnetic backing, with a cork and perforated steel backing. Single key 4x(8.5"x11"), double key 6x(8.5"x11"), 9x(8.5"x11") and 12x(8.5"x11") sizes are available and can be used both in portrait & landscape positions. The cover can be opened to 90 degrees. Each unit includes mounting screw and plugs for easy wall mounting and a free set of pins&magnets. The profile width is 1.77" and the depth of the case 1.42".

Each product includes 1 key set of single variation.

Each unit includes a free of pins. 2 stays at each end help to keep the cover door open.

Please discard the protective film on the unit before use. Please throw away the silicagel on the cork before use.

Size of boards for all Showboard models:

	4x(8.5"x11")		6x(8.5"x11")		9x(8.5"x11")		12x(8.5"x11")	
(8.5"x11")	(8.5"x11")	(8.5"x11")	(8.5"x11")	(8.5"x11")	(8.5"x11")	(8.5"x11")	(8.5"x11")	(8.5"x11")
(8.5"x11")	(8.5"x11")	(8.5"x11")	(8.5"x11")	(8.5"x11")	(8.5"x11")	(8.5"x11")	(8.5"x11")	(8.5"x11")
(8.5"x11")	(8.5"x11")	(8.5"x11")	(8.5"x11")	(8.5"x11")	(8.5"x11")	(8.5"x11")	(8.5"x11")	(8.5"x11")
(8.5"x11")	(8.5"x11")	(8.5"x11")	(8.5"x11")	(8.5"x11")	(8.5"x11")	(8.5"x11")	(8.5"x11")	(8.5"x11")



M&C



Magnetic



Cork

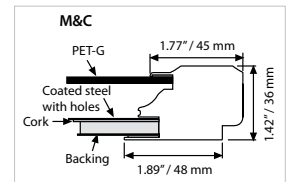
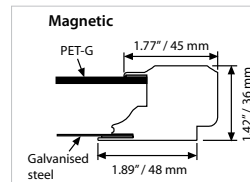
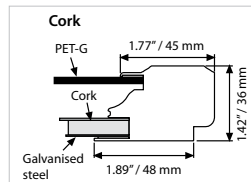
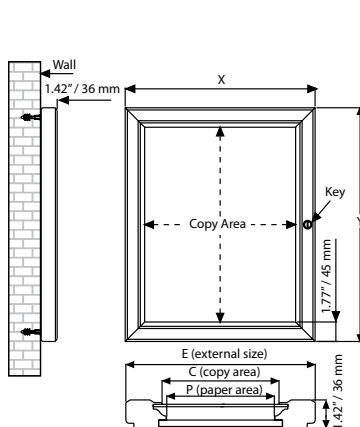

MATERIAL : Silver anodised aluminium

CORK	MAGNETIC	M&C	EXTERNAL (x-y)	COPY	PAPER AREA	CAPACITY	KEY	WEIGHT WITH PACKING			PACKING SIZE
USBN1004A4	USBN2004A4	USBN3004A4	23.03" X 29.72"	19.49" X 26.18"	19.02" X 25.71"	4 X (8.5" X 11")	1	15.145 lbs	13.227 lbs	18.188 lbs	24.41" X 30.71" X 2.36"
USBN1006A4	USBN2006A4	USBN3006A4	23.03" X 42.32"	19.49" X 38.78"	19.02" X 38.31"	6 X (8.5" X 11")	2	19.731 lbs	18.408 lbs	24.250 lbs	24.41" X 43.31" X 2.36"
USBN1009A4	USBN2009A4	USBN3009A4	32.09" X 42.32"	28.54" X 38.78"	28.07" X 38.31"	9 X (8.5" X 11")	2	27.557 lbs	25.573 lbs	33.289 lbs	33.46" X 43.31" X 2.36"
USBN1012A4	USBN2012A4	USBN3012A4	41.14" X 42.32"	37.60" X 38.78"	37.13" X 38.31"	12 X (8.5" X 11")	2	33.951 lbs	31.327 lbs	41.887 lbs	42.52" X 43.31" X 2.36"



*W:Width H:Height D:Depth

Felt Showboard



Suitable for outdoor use. It has a felt backing that welcomes both Velcro and pins. Each unit includes a free set of pins. Single key 4x(8.5"x11"), double key 6x(8.5"x11"), 9x(8.5"x11") and 12x(8.5"x11") sizes are available and can be used both in portrait & landscape positions. The cover can be opened to 90 degrees. Each unit includes mounting screw and plugs for easy wall mounting and a free set of pins. The profile width is 1.77" and the depth of the case 1.42".

- Each product includes 1 key set of single variation.
- Each unit includes a free of pins. 2 stays at each end help to keep the cover door open.
- Please discard the protective film on the unit before use

Size of boards for all Showboard models:

4x(8.5"x11")		6x(8.5"x11")		9x(8.5"x11")		12x(8.5"x11")	
(8.5"x11")	(8.5"x11")	(8.5"x11")	(8.5"x11")	(8.5"x11")	(8.5"x11")	(8.5"x11")	(8.5"x11")
(8.5"x11")	(8.5"x11")	(8.5"x11")	(8.5"x11")	(8.5"x11")	(8.5"x11")	(8.5"x11")	(8.5"x11")



Blue



Gray



Green



Red

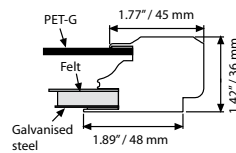
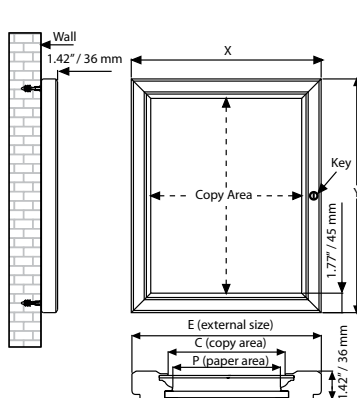

Choice of 4 felt colours

 Gray Blue Green Red

MATERIAL : Silver anodised aluminium								WEIGHT	PACKING SIZE	
RED	BLUE	GRAY	GREEN	EXTERNAL (x-y)	COPY	PAPER AREA	CAPACITY	KEY	WITH PACKING	*W X H X D
USBN1104A4	USBN1204A4	USBN1404A4	USBN1304A4	23.03" X 29.72"	19.49" X 26.18"	19.02" X 25.71"	4 X (8.5" X 11")	1	18.629 lbs	24.41" X 30.71" X 2.36"
USBN1106A4	USBN1206A4	USBN1406A4	USBN1306A4	23.03" X 42.32"	19.49" X 38.78"	19.02" X 38.31"	6 X (8.5" X 11")	2	22.928 lbs	24.41" X 43.31" X 2.36"
USBN1109A4	USBN1209A4	USBN1409A4	USBN1309A4	32.09" X 42.32"	28.54" X 38.78"	28.07" X 38.31"	9 X (8.5" X 11")	2	31.085 lbs	33.46" X 43.31" X 2.36"
USBN1112A4	USBN1212A4	USBN1412A4	USBN1312A4	41.14" X 42.32"	37.60" X 38.78"	37.13" X 38.31"	12 X (8.5" X 11")	2	39.683 lbs	42.52" X 43.31" X 2.36"



*W:Width H: Height D: Depth

Noticeboards



Suitable for outdoor use. 4x(8.5"x11"), 6x(8.5"x11"), 9x(8.5"x11"), 12x(8.5"x11") paper capacity sizes are available. Noticeboard can be used both in portrait and landscape positions. Each unit includes a free set of pins or magnets. The profile width is 2.76" and the depth of the case 1.97".

Each product includes 2 mounting arms, 1 key set single variation & fixing set.

Each unit comes with a free set of magnets. 2 handles at each end help to keep the cover door open.

Please do not drill the product while mounting, only use the mounting arms. Please throw away the protection film on the unit before use.



Cork

Magnetic

M&C

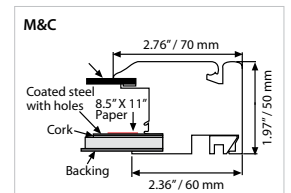
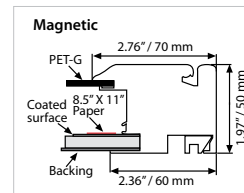
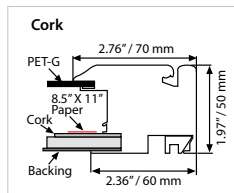
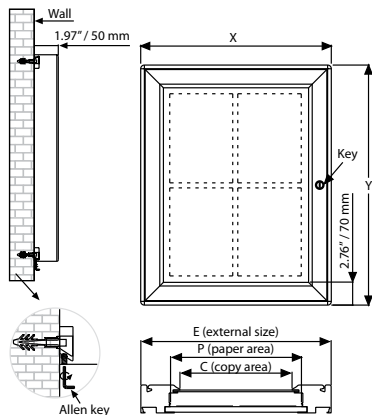

MATERIAL : Silver anodised aluminium							WEIGHT WITH PACKING			PACKING SIZE
CORK	MAGNETIC	M&C	EXTERNAL (x-y)	PAPER AREA	COPY	CAPACITY	CORK	MAGNETIC	M&C	*W X H X D
UNBN0004A4	UNBN1004A4	UNBN2004A4	23.23" X 29.92"	19.02" X 25.71"	17.72" X 24.41"	4 X (8.5" X 11")	18.739 lbs	21.495 lbs	21.495 lbs	24.41" X 30.71" X 3.15"
UNBN0006A4	UNBN1006A4	UNBN2006A4	23.23" X 42.52"	19.02" X 38.31"	17.72" X 37.01"	6 X (8.5" X 11")	24.802 lbs	29.409 lbs	29.321 lbs	24.41" X 43.31" X 3.15"
UNBN0009A4	UNBN1009A4	UNBN2009A4	32.28" X 42.52"	28.07" X 38.31"	26.77" X 37.01"	9 X (8.5" X 11")	32.187 lbs	38.801 lbs	38.801 lbs	33.46" X 43.31" X 3.15"
UNBN0012A4	UNBN1012A4	UNBN2012A4	41.34" X 42.52"	37.13" X 38.31"	35.83" X 37.01"	12 X (8.5" X 11")	40.344 lbs	48.986 lbs	47.289 lbs	42.52" X 43.31" X 3.115"



* W:Width H: Height D: Depth

Noticeboard with Led Light



Suitable for outdoor use. LEDs on the top and the bottom of the profile illuminate the interior of the frame. 4x(8.5"x11"), 6x(8.5"x11"), 9x(8.5"x11") and 12x(8.5"x11") paper capacity sizes are available. Noticeboard can be used both in portrait and landscape positions. Each unit includes a free set of pins or magnets. The profile width is 2.76" and the depth of the case 1.97".

Each product includes 2 mounting arms, 1 key set single variation & fixing set. Delivered with 3,5 meter long EU plug and cable. UK and US plug should be specified with order. All units pass CE/UL Pat test.

Each unit comes with a free set of pins. 2 handles at each end help to keep the cover door open.

Please throw away the silicagel on the cork once the unit is opened. Please do not drill the product while mounting, only use the mounting arms. Please throw away the protection film on the unit before use.



Size of boards for all Noticeboards models:

4x(8.5"x11")		6x(8.5"x11")		9x(8.5"x11")			12x(8.5"x11")		
(8.5"x11")	(8.5"x11")	(8.5"x11")	(8.5"x11")	(8.5"x11")	(8.5"x11")	(8.5"x11")	(8.5"x11")	(8.5"x11")	(8.5"x11")
(8.5"x11")	(8.5"x11")	(8.5"x11")	(8.5"x11")	(8.5"x11")	(8.5"x11")	(8.5"x11")	(8.5"x11")	(8.5"x11")	(8.5"x11")
(8.5"x11")	(8.5"x11")	(8.5"x11")	(8.5"x11")	(8.5"x11")	(8.5"x11")	(8.5"x11")	(8.5"x11")	(8.5"x11")	(8.5"x11")

MATERIAL : Silver anodised aluminium							WEIGHT WITH PACKING			PACKING SIZE
CORK	MAGNETIC	M&C	EXTERNAL (x-y)	PAPER AREA	COPY	CAPACITY	CORK	MAGNETIC	M&C	*W X H X D
UNBNOL04A4	UNBN1L04A4	UNBN2L04A4	23.23" X 29.92"	19.02" X 25.71"	17.72" X 24.41"	4 X (8.5" X 11")	18.739 lbs	21.495 lbs	21.495 lbs	24.41" X 30.71" X 3.15"
UNBNOL06A4	UNBN1L06A4	UNBN2L06A4	23.23" X 42.52"	19.02" X 38.31"	17.72" X 37.01"	6 X (8.5" X 11")	24.802 lbs	29.409 lbs	29.321 lbs	24.41" X 43.31" X 3.15"
UNBNOL09A4	UNBN1L09A4	UNBN2L09A4	32.28" X 42.52"	28.07" X 38.31"	26.77" X 37.01"	9 X (8.5" X 11")	32.187 lbs	38.801 lbs	38.801 lbs	33.46" X 43.31" X 3.15"





* W:Width H: Height D: Depth

Noticeboard with Logo



Suitable for outdoor use, Noticeboard is designed further for logo applications or branding options. 4x(8.5"x11"), 6x(8.5"x11"), 9x(8.5"x11") and 12x(8.5"x11") paper capacity sizes are available. The profile width is 2.76" and case depth is 1.57". It is produced by durable aluminium frames and vandal resistant glazing panels.

-  Each product includes 2 mounting arms, 1 key set single variation & fixing set.
-  Each unit comes with a free set of magnets. 2 handles at each end help to keep the cover door open.
-  Please do not drill the product while mounting, only use the mounting arms. Please throw away the protection film on the unit before use.



Magnetic



Cork

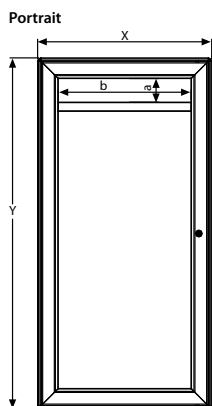
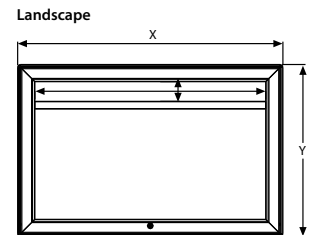

MATERIAL : Silver anodised aluminium							WEIGHT WITH PACKING		PACKING SIZE
CORK	MAGNETIC	EXTERNAL (x-y)	PAPER AREA	LOGO (a-b)	CAPACITY	DESCRIPTION	CORK	MAGNETIC	*W X H X D
UNBN0504A4	UNBN1504A4	23.23" X 34.25"	19.02" X 25.71"	17.72" X 3.15"	4 X (8.5" X 11")	Portrait	21.495 lbs	23.765 lbs	24.41" X 35.83" X 3.15"
UNBN0506A4	UNBN1506A4	23.23" X 46.85"	19.02" X 38.31"	17.72" X 3.15"	6 X (8.5" X 11")	Portrait	27.557 lbs	32.187 lbs	24.41" X 48.43" X 3.15"
UNBN0509A4	UNBN1509A4	32.28" X 46.85"	28.07" X 38.31"	26.77" X 3.15"	9 X (8.5" X 11")	Portrait	37.037 lbs	39.462 lbs	870 X 48.43" X 3.15"
UNBN0512A4	UNBN1512A4	41.34" X 46.85"	37.13" X 38.31"	35.83" X 3.15"	12 X (8.5" X 11")	Portrait	44.974 lbs	54.013 lbs	1080 X 48.43" X 3.15"
UNBN0704A4	UNBN1704A4	29.92" X 27.56"	25.71" X 19.02"	24.41" X 3.15"	4 X (8.5" X 11")	Landscape	22.266 lbs	24.537 lbs	28.74" X 31.50" X 3.15"
UNBN0706A4	UNBN1706A4	42.52" X 27.56"	28.74" X 19.02"	37.01" X 3.15"	6 X (8.5" X 11")	Landscape	28.660 lbs	32.033 lbs	28.74" X 44.09" X 3.15"
UNBN0709A4	UNBN1709A4	42.52" X 36.61"	28.74" X 28.07"	37.01" X 3.15"	9 X (8.5" X 11")	Landscape	38.250 lbs	41.446 lbs	960 X 44.09" X 3.15"
UNBN0712A4	UNBN1712A4	42.52" X 45.67"	28.74" X 37.13"	37.01" X 3.15"	12 X (8.5" X 11")	Landscape	47.178 lbs	51.808 lbs	43.70" X 47.24" X 3.15"



* W:Width H: Height D: Depth



Floor Signs

- Flexible Sign Holders
- Flexible Sign Holder with LEDbox
- Arc Sign Holder **NEW**
- Telescoping Sign Holders **NEW**
- Floor Sign Holder **NEW**
- Folder Sign Holder
- Restaurant Boards
- Curved Sign Holder
- Curved Sign Holder with Acryled
- Universal Showboard on Curved Post
- Paper Board Sign Holder
- Classical Sign Holder
- Decorative Sign Holder
- Adjustable Sign Holder



Flexible Sign Holder



See movie at our website www.mtdisplays.com.tr



Genuine design, one product, multifunctional. With our newly designed product, we would like to bring a new dimension of performance in menuboard. The Flexible Sign Holder fulfills multiple functions thanks to its adjustable height and paper position applications through various standing angles on the back. The height of the unit, the landscape/portrait positioning and the eye catching view angle are all flexible. The product is protected worldwide by all required patent and design applications. It has already been certified in DE (Germany), FR (France), US (United States of America), JP (Japan) and OHIM (European union) papers. The worldwide patent is pending.

Packed unassembled with an easy-to-understand instruction sheet.

Heavy base provides stability in highly frequented areas.

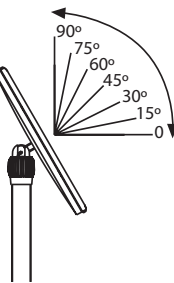

Patent: TR 2007 06354 - TR 2007 03453 - PCT/TR 2007/000131 - DE 20 2007 016 574 - OHIM 000748223-0001,2 - FR 760305 - US 29/295.750 - US D 597, 764 S - JP 2007-022472 - JP 2007-022473 - CN 200730321542.4 - CN 200730321543.

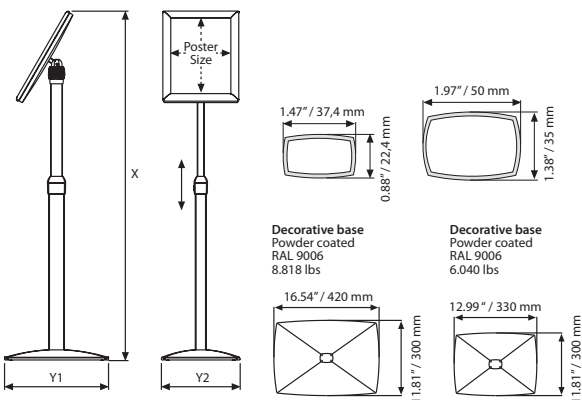

MATERIAL : Silver anodised aluminium							WEIGHT	PACKING SIZE
ARTICLE	X max.	X min.	Y1	Y2	POSTER	DESCRIPTION	WITH PACKING	*W X H X D
UDMB600581	47.44"	34.06"	12.99"	9.84"	8.5" X 11"	Landscape	10.141 lbs	11.22" X 40.55" X 4.02"
	49.21"	35.83"	12.99"	9.84"		Portrait	10.141 lbs	11.22" X 40.55" X 4.02"
UDMB600517	49.61"	35.43"	16.54"	11.81"	11" X 17"	Landscape	13.889 lbs	14.37" X 43.70" X 4.02"
	51.97"	37.80"	16.54"	11.81"		Portrait	13.889 lbs	14.37" X 43.70" X 4.02"
UDMB600518	55.51"	34.25"	16.54"	11.81"	18" X 22"	Landscape	17.196 lbs	20.67" X 52.36" X 4.02"
			16.54"	11.81"		Portrait	17.196 lbs	20.67" X 52.36" X 4.02"

*W:Width H: Height D: Depth



Flexible Sign Holder with Fixed Height



See movie at our website www.mtdisplays.com.tr



Genuine design, one product, 2 positions.
 With our newly designed product, we would like to bring a new dimension of performance in menuboard. The Flexible Sign Holder fulfills multiple functions thanks to its paper position applications through various standing angles on the back. The landscape/portrait positioning and the eye catching view angle are all flexible. The product is protected worldwide by all required patent and design applications. It has already been certified in DE (Germany), FR (France), US (United States of America), JP (Japan) and OHIM (European union) papers. The worldwide patent is pending.

Packed unassembled with an easy-to-understand instruction sheet.

Heavy base provides stability in highly frequented areas.



Patent: TR 2007 06354 - TR 2007 03453 - PCT/TR 2007/000131 - DE 20 2007 016 574 - OHIM 000748223-0001,2 - FR 760305 - US 29/295.750 - US D 597, 764 S - JP 2007-022472 - JP 2007-022473 - CN 200730321542.4 - CN 200730321543.

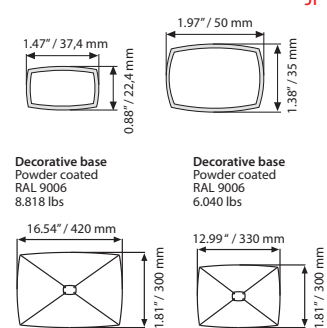
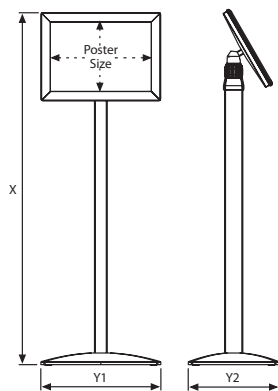

MATERIAL : Silver anodised aluminium					WEIGHT	PACKING SIZE
ARTICLE	Y1	Y2	POSTER	DESCRIPTION	WITH PACKING	*W X H X D
UDMB700581	12.99"	9.84"	8.5" X 11"	Landscape	11.166 lbs	11.22" X 40.55" X 4.02"
	12.99"	9.84"	8.5" X 11"	Portrait	11.166 lbs	11.22" X 40.55" X 4.02"
UDMB700517	16.54"	11.81"	11" X 17"	Landscape	14.870 lbs	14.37" X 43.70" X 4.02"
	16.54"	11.81"	11" X 17"	Portrait	14.870 lbs	14.37" X 43.70" X 4.02"
UDMB700518	16.54"	11.81"	18" X 22"	Landscape	17.196 lbs	20.67" X 52.36" X 4.06"
	16.54"	11.81"	18" X 22"	Portrait	17.196 lbs	20.67" X 52.36" X 4.06"



* W:Width H: Height D: Depth

Flexible Sign Holder with LEDbox



See movie at our website www.mtdisplays.com.tr

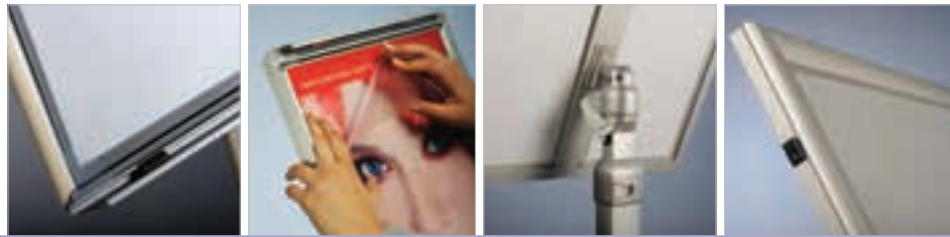

Genuine Design, One product, Multi function.
Flexible Sign Holder with Ledbox bring a new dimension of performance in menuboards. It is in multi functional service of height and paper position application with variety of standing angles at the back. The height of the unit, landscape/portrait positioning or even eye catching view angle is flexible. The product is protected in world with all required patent and design applications and already certified with DE (Germany), FR(France), US (United States of America), JP (Japan) and OHIM (European union) papers. PCT worldwide patent is pending. Special treated acrylic and LED technology illuminates prints homogenous. Silver and black models are available in A4&A3 sizes. Black is only available at fixed height.

All units pass CE/UL PAT test. Packed with quality certificates & 3,5 meter electrical cable. UK and US plugs should be mentioned on order. Packed unassembled with an easy instruction sheet.

Led illumination saves up to 60% energy cost. Heavy base provide stability in crowded areas.

Color options : Silver-anodized & black

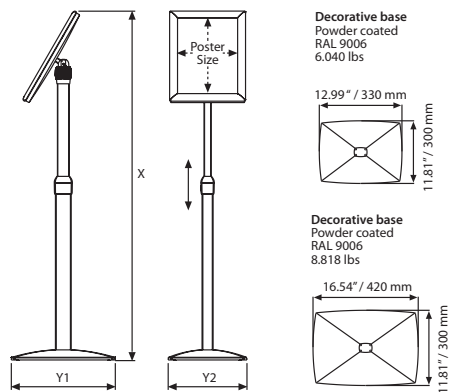

MATERIAL : Silver anodised aluminium								WEIGHT	PACKING SIZE
ARTICLE	X max.	X min.	Y1	Y2	POSTER	DESCRIPTION	LIGHTING	WITH PACKING	*W X H X D
UFML00N017	48.50"	35.12"	16.54"	11.81"	11" X 17"	Silver Landscape	1800-2200 LUX	19.841 lbs	14.57" X 50.79" X 6.10"
	52.05"	36.30"	16.54"	11.81"		Silver Portrait	1800-2200 LUX	19.841 lbs	14.57" X 50.79" X 6.10"
UFML00N018	55.63"	42.24"	16.54"	11.81"	18" X 24"	Silver Landscape	1800-2100 LUX	15.432 lbs	20.67" X 52.36" X 4.06"
	59.06"	43.31"	16.54"	11.81"		Silver Portrait	1700-2100 LUX	15.432 lbs	20.67" X 52.36" X 4.06"
UFML10B017	fixed height	fixed height	16.54"	11.81"	11" X 17"	Black Landscape	1900-2100 LUX	16.424 lbs	14.76" X 42.13" X 4.33"
	fixed height	fixed height	16.54"	11.81"		Black Portrait	1900-2100 LUX	16.424 lbs	14.76" X 42.13" X 4.33"
UFML10B018	fixed height	fixed height	16.54"	11.81"	18" X 24"	Black Landscape	1800-2200 LUX	15.432 lbs	20.67" X 52.36" X 4.06"
	fixed height	fixed height	16.54"	11.81"		Black Portrait	1800-2200 LUX	15.432 lbs	20.67" X 52.36" X 4.06"

*W:Width H: Height D: Depth



ARC Sign Holder

new



See movie at our website www.mtdisplays.com.tr



Arc Menuboard is a stylish menu or brochure holder with its curved design for modern environment. It is equipped with steel base for stability. anti-reflex magnetic poster cover holds poster in place which enables users to quickly change out messages or prints without having to use any tools. It is a practical solutions for banks, hotels and other businesses to advertise in their lobbies or just restaurants and cafes. It is available in the sizes 8.5"x11" and 11"x17".

- Packed unassembled with easy-to-understand instruction sheet & fixing kit
- Magnetic anti reflex poster cover included.
- 2 packs. See info chart for pack sizes.
- Assembly time approx 40 seconds.

Color options

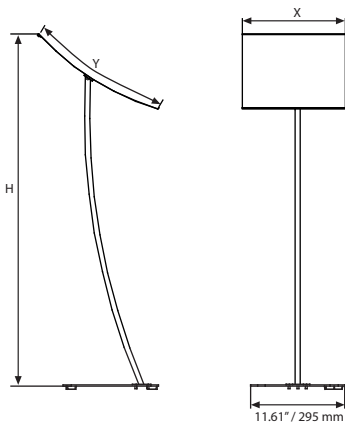
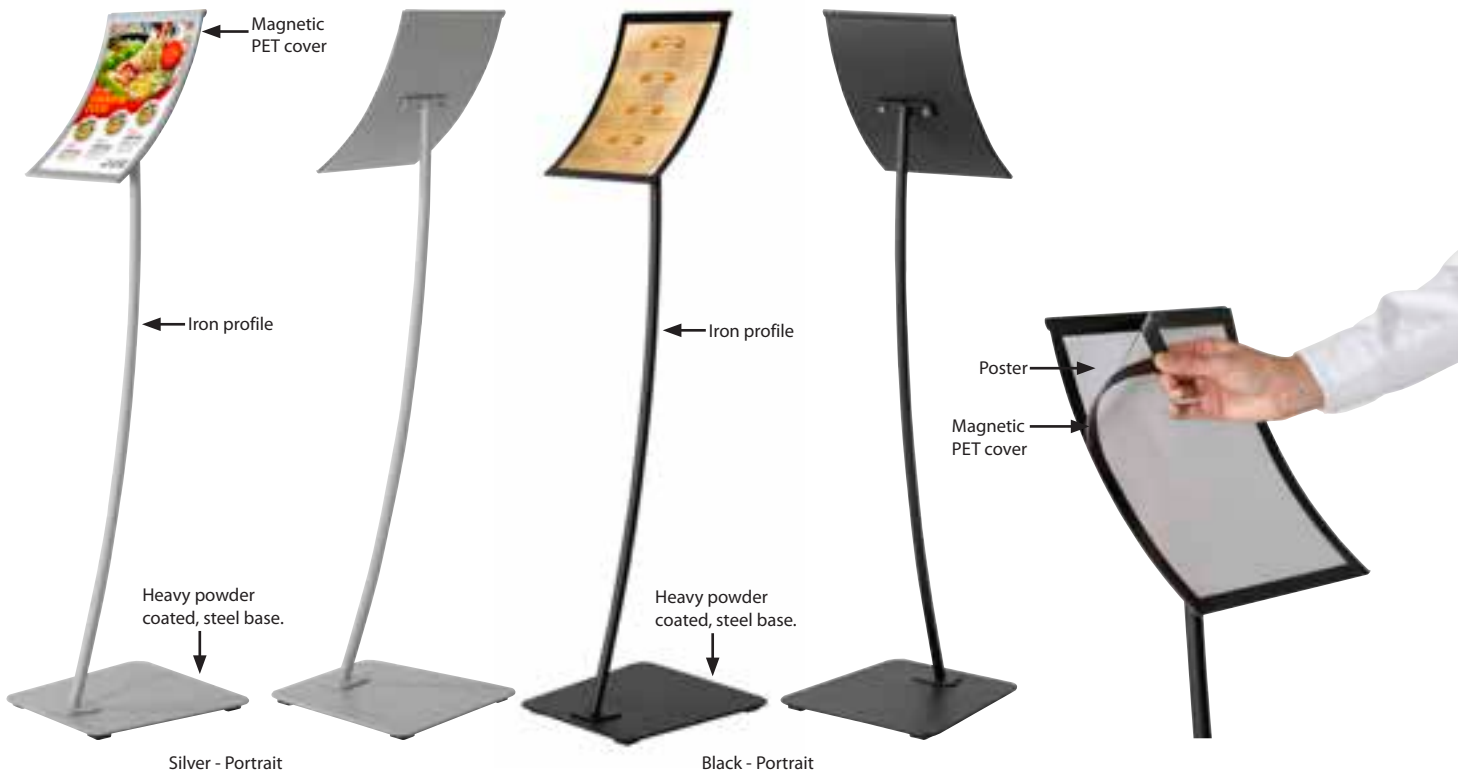

MATERIAL : Silver anodised aluminium						WEIGHT	PACKING SIZE
ARTICLE	DESCRIPTION	EXTERNAL (x-y)	POSTER	COPY	H	WITH PACKING	*W X H X D
UAMBOPOB81	Black	9.69" X 12.20"	8.5" X 11"	8.35" X 10.87"	42.52"	10.141 lbs	12.99" X 39.76" X 3.15"
UAMBOPOB17	Black	12.13" X 18.19"	11" X 17"	10.87" X 16.85"	44.29"	11.331 lbs	14.57" X 40.55" X 3.15"
UAMBOPOG81	Silver	9.69" X 12.20"	8.5" X 11"	8.35" X 10.87"	42.52"	10.141 lbs	12.99" X 39.76" X 3.15"
UAMBOPOG17	Silver	12.13" X 18.19"	11" X 17"	10.87" X 16.85"	44.29"	11.331 lbs	14.57" X 40.55" X 3.15"

*W:Width H: Height D: Depth



Telescoping Sign Holder Slide-in Frame

new



See movie at our website www.mtdisplays.com.tr



Telescoping Menuboard Double Sided is equipped with Slide in Frame which provides view from both sides. Its telescoping feature allows adjusting the height of advertisement. Slide-in Frame makes the change of poster easy. It is suitable for use in hotels, galleries, museums, restaurants, lobby, bars, etc. Simply slide out the old protection cover, and then place your double sided poster in between and slide in the frame. A heavy duty steel base stabilizes the height adjustable pole. It is available in the sizes 8.5"x11" and 11"x17" both in landscape & portrait positions in the same Product.

- Telescoping Menuboards are packed unassembled with an easy-to-understand instruction sheet & fixing elements and 2 anti-reflex pet covers.
- Height adjustable with help of clamp.
- Adjustable to portrait or landscape position.
- 1 pack. See info chart for pack sizes.
- Assembly time approx 35 seconds.

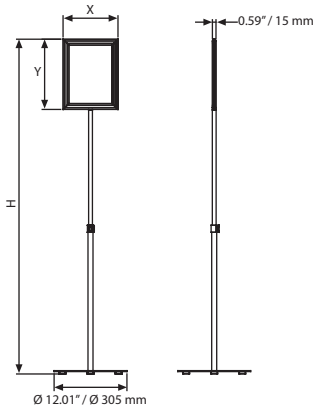

Color options
 Silver
 Black / RAL 9005

MATERIAL : Silver & black anodised aluminium							WEIGHT	PACKING SIZE
MITRED ARTICLE	EXTERNAL (x-y)	POSTER	COPY	H min.	H max.	DESCRIPTION	WITH PACKING	*W X H X D
UMBD20B81	9.16" X 11.57"	8.5" X 11"	7.09" X 9.61"	37.28"	55.55"	Portrait / Black		
				32.95"	51.22"	Landscape / Black		
UMBD20B17	11.57" X 17.56"	11" X 17"	9.61" X 15.59"	41.22"	59.49"	Portrait / Black		
				37.52"	55.79"	Landscape / Black		
UMBD20N81	9.16" X 11.57"	8.5" X 11"	7.09" X 9.61"	37.28"	55.55"	Portrait / Silver		
				32.95"	51.22"	Landscape / Silver		
UMBD20N17	11.57" X 17.56"	11" X 17"	9.61" X 15.59"	41.22"	59.49"	Portrait / Silver		
				37.52"	55.79"	Landscape / Silver		

*W:Width H: Height D: Depth



Telescoping Sign Holder Snap Frame

new



See movie at our website www.mtdisplays.com.tr



Telescoping Menuboard with Snap Frame, is equipped with Snap Frame which provides landscape and portrait adjustment easily. Its telescoping feature allows adjusting the height of advertisement. Snap Frame makes the change of poster easy. It is suitable for use in hotels, galleries, museums, restaurants, lobby, bars, etc. A heavy duty steel base stabilizes the height adjustable pole. It is available in the sizes 8.5"x11" and 11"x17" both in landscape & portrait positions in the same product.

- Packed unassembled with an easy-to-understand instruction sheet & fixing elements and 1 anti-reflex pet covers. Height adjustable with help of clamp.
- Height adjustable with help of clamp.
- Adjustable to portrait or landscape position.
- 1 pack. See info chart for pack sizes.
- Assembly time approx 35 seconds.

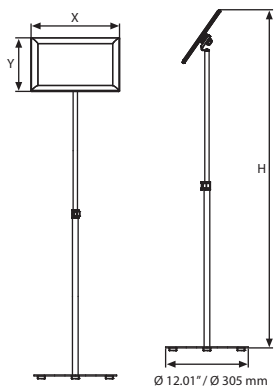
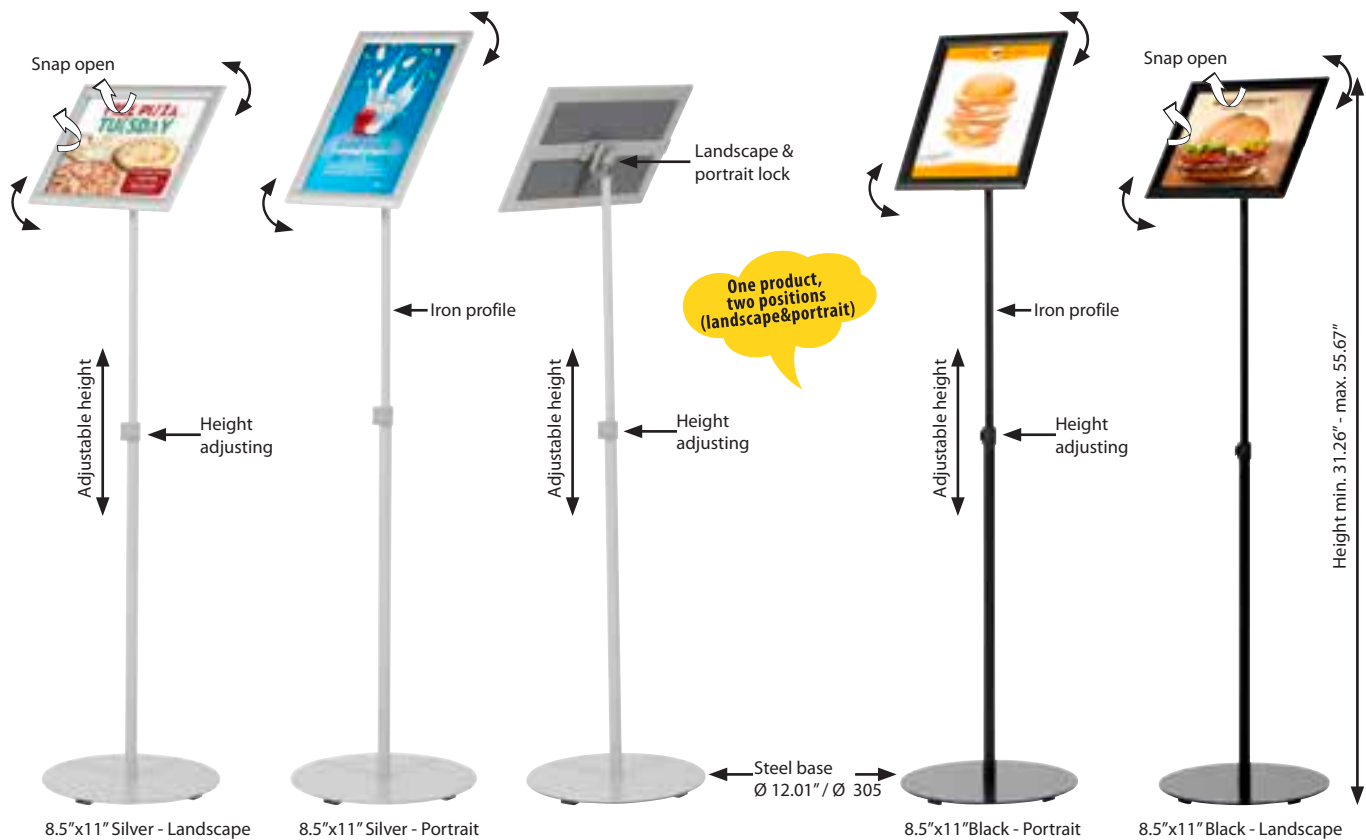

Color options
 Silver
 Black / RAL 9005

MATERIAL : Silver & black anodised aluminium PROFILE : 25 mm 45°							WEIGHT	PACKING SIZE
MITRED ARTICLE	EXTERNAL (x-y)	POSTER	COPY	H min.	H max.	DESCRIPTION	WITH PACKING	*W X H X D
UMBTS10B81	9.69" X 12.20"	8.5" X 11"	7.80" X 10.31"	33.07"	51.18"	Portrait / Black		
				31.26"	49.37"	Landscape / Black		
UMBTS10B17	12.20" X 18.19"	11" X 17"	10.31" X 16.69"	37.40"	55.67"	Portrait / Black		
				35.67"	53.98"	Landscape / Black		
UMBTS10N81	9.69" X 12.20"	8.5" X 11"	7.80" X 10.31"	33.07"	51.18"	Portrait / Silver		
				31.26"	49.37"	Landscape / Silver		
UMBTS10N17	12.20" X 18.19"	11" X 17"	10.31" X 16.69"	37.40"	55.67"	Portrait / Silver		
				35.67"	53.98"	Landscape / Silver		

*W:Width H: Height D: Depth



Floor Sign Holder

new



See movie at our website www.mtdisplays.com.tr



Floor Sign Holder is a landscape sign holder. The graphic is inserted from the top. Steel made of base is heavy which stabilizes the pole. It is double sided to make the advertisement visible from both sides. It is supplied without poster protector. It takes seconds to set up the sign with easy-to-mount instructions. As the pole is 3 parts, it provides 3 height options to Floor sign.



Color options



Silver



Black / RAL 9005

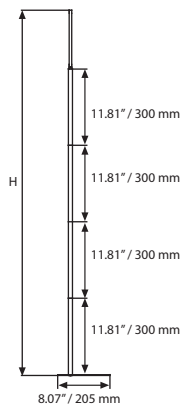
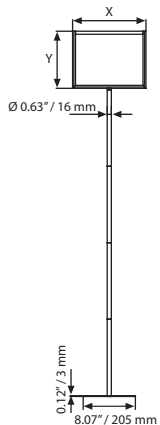
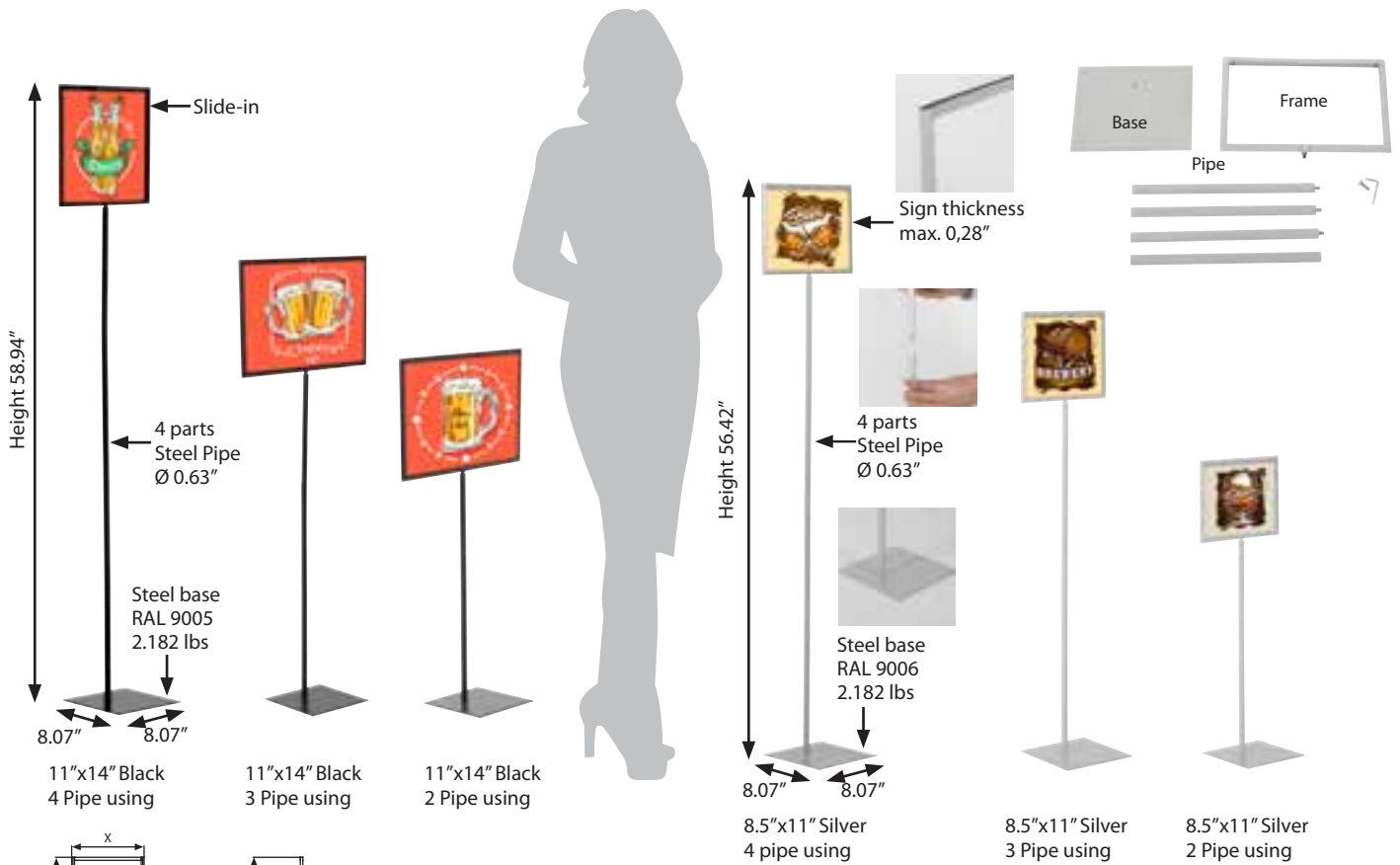

MATERIAL : Silver & black anodised aluminium					WEIGHT	PACKING SIZE	
ARTICLE	EXTERNAL (x-y)	POSTER	COPY	H max.	DESCRIPTION	WITH PACKING	*W X H X D
USHFOP081	11.34" X 8.82"	8.5" X 11"	7.89" X 10.04"	56.42"	8.5" X 11" / Black		
USHFOP081	11.34" X 8.82"	8.5" X 11"	7.89" X 10.04"	56.42"	8.5" X 11" / Silver		
USHFOP0814	14.33" X 11.34"	11" X 14"	10.41" X 13.43"	58.94"	11" X 14" / Black		
USHFOP0814	14.33" X 11.34"	11" X 14"	10.41" X 13.43"	58.94"	11" X 14" / Silver		

*W:Width H: Height D: Depth





Folder Sign Holder



See movie at our website www.mtdisplays.com.tr



The Folder Sign Holder has a transparent acrylic shelf catching the eye level. It has a ring binder available to hold 2x4 individual menu pages. With the usage of the channeled elliptic profile and any acrylic or steel shelf, a frame can quickly reveal the advantages of the product.

-  Folder Sign Holders are packed unassembled with an easy-to-understand instruction sheet & fixing elements.
-  Heavy elegant base provides stability.
-  As optional accessory, extra shelves can be added to the leg.



UFSL002100



UFSL003100



UFSL002200



UFSL003200



UFSL003300

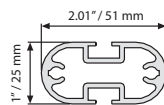
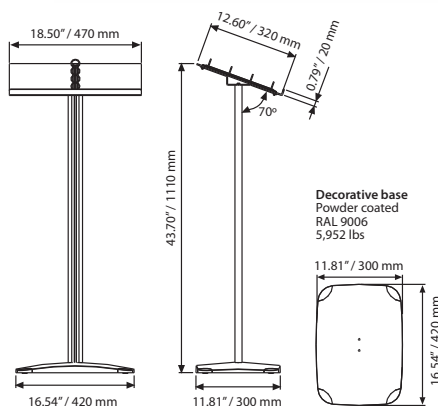

Some possible Variations/Mögliche Variationen.

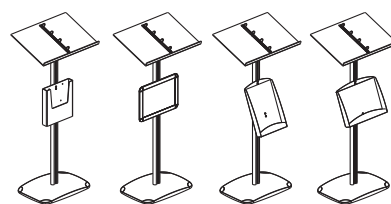

SHELF			WEIGHT	PACKING SIZE
ARTICLE	CAPACITY	DESCRIPTION	WITH PACKING	*W X H X D
UFSL002100	2 X (5.5" X 8.5")	Steel shelf	3.273 lbs	13.39" X 11.42" X 2.48"
UFSL003100	2 X (5.5" X 8.5")	Acrylic shelf	1.962 lbs	13.39" X 11.42" X 2.48"
UFSL002200	1 X (8.5" X 11")	Steel shelf	2.568 lbs	9.84" X 14.57" X 2.48"
UFSL003200	1 X (8.5" X 11")	Acrylic shelf	1.785 lbs	9.84" X 14.57" X 2.48"
UFSL003300	1 X (8.5" X 11")	Acrylic shelf	1.344 lbs	9.45" X 10.63" X 2.17"

MATERIAL : Silver anodised aluminium		WEIGHT	PACKING SIZE
ARTICLE	CAPACITY	WITH PACKING	*W X H X D
UDMB2002A4	2 X (8.5" X 11")	15.101 lbs	14.96" X 42.13" X 1.97"





*W:Width H:Height D:Depth

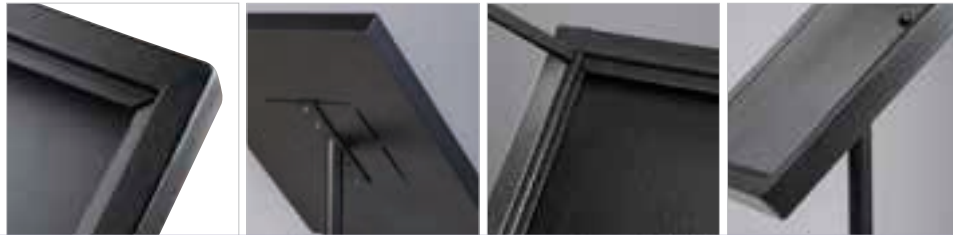

Restaurant Boards



Heavy duty outdoor Restaurant board is ideal for displaying menus, special offers, events and more. Restaurant Boards are designed smart to cover magnetic tape on the cover with Black silk screen printing. These versatile menuboards are produced with durable steel material to suit outdoor conditions. Steel base covered with soft material to protect the floors. Textured black or Black-Grey finishes offers options to users. It is easy to change the message. It captures the customer's attention in all frequented traffic areas.

-  Suitable for outdoor use.
-  Magnets included in each product. Magnetic cover .
-  Single leg can be adjusted to portrait or landscape position.
-  4 packs. See info chart for pack sizes.



Powder coated base 19.841 lbs

Black

Black Hammered

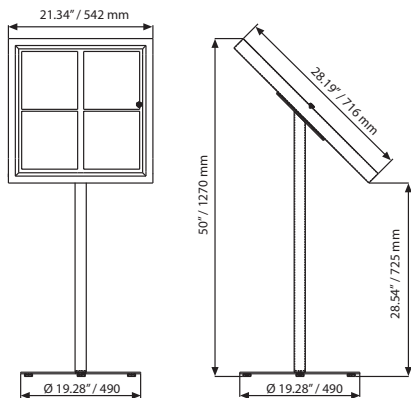

Magnetic buttons
UYUP397000

 Color options :
Black & hammered black

MATERIAL : Black & black hammered powder coated				WEIGHT	PACKING SIZE
ARTICLE	CAPACITY	DESCRIPTION	HEIGHT	WITH PACKING	*W X H X D
UMB00B04A4	4 X (8.5" X 11")	Black	50" / Portrait	52.029 lbs	8.66" X 44.09" X 2.76"
					22.83" X 28.35" X 2.76"
UMB00N04A4	4 X (8.5" X 11")	Hammered Black	47.44" / Landscape	52.029 lbs	8.66" X 44.09" X 2.76"
					22.83" X 28.35" X 2.76"
					24.02" X 2.76" X 0.31"



*W:Width H: Height D: Depth



Restaurant Boards



Heavy duty outdoor Restaurant board is ideal for displaying menus, special offers, events and more. Restaurant Boards are designed smart to cover magnetic tape on the cover with Black silk screen printing. These versatile menuboard are produced with durable steel material to suit outdoor conditions. Steel base covered with soft material to protect the floors. Textured black or Black-Grey finishes offers options to users. It is easy to change the message. It captures the customer's attention in all frequented traffic areas.

-  Suitable for outdoor use.
-  Magnets included in each product. Magnetic cover .
-  4 packs. See info chart for pack sizes.



Black

Black Hammered

Powder coated base 24.250 lbs

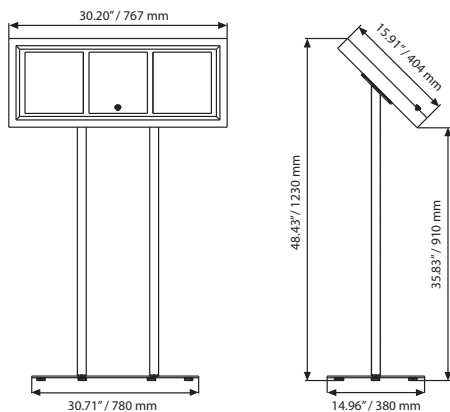

Magnetic buttons
UYUP397000

Color options :
Black & hammered black

MATERIAL : Black & black hammered powder coated			WEIGHT	PACKING SIZE
ARTICLE	CAPACITY	DESCRIPTION	WITH PACKING	*W X H X D
UMBO0B03A4	3 X (8.5" X 11")	Black	48.060 lbs	16.54" X 32.28" X 1.18"
				7.09" X 46.06" X 2.36"
UMBO0N03A4	3 X (8.5" X 11")	Hammered Black	48.060 lbs	16.54" X 32.28" X 1.18"
				7.09" X 46.06" X 2.36"
				17.32" X 34.65" X 0.31"

* W:Width H: Height D: Depth



Curved Sign Holder



See movie at our website www.mtdisplays.com.tr



The Curved Sign Holder has both a silver & a black finish. Our new stylish Curved Sign Holder captures the customers attention in all frequented traffic areas. The Curved Sign Holder is suitable for use in hotels, galleries, museums, restaurants, lobby, bars, etc.. It is available in 8.5" x 11" and 11" x 17" portrait and landscape positions.

Menu boards are packed unassembled with complete instructions and fixing hardware for assembly.

Heavy elegant base provides stability.

Color options :
Silver-anodized & black

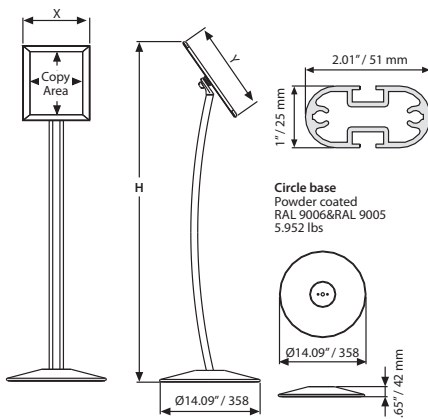

MATERIAL : Silver & Black anodised aluminium								WEIGHT	PACKING SIZE
MITRED SILVER	ROUND SILVER	MITRED BLACK	EXTERNAL (x-y)	POSTER	COPY	HEIGHT	DESCRIPTION	WITH PACKING	*W X H X D
UCUMBN0581	UCUMBN0081	UCUMBB0581	9.68" X 12.18"	8.5" X 11"	7.79" X 10.29"	47.72"	Portrait	12.169 lbs	20.67" X 52.36" X 4.06"
						46.30"	Landscape		
UCUMBN0517	UCUMBN0017	UCUMBB0517	12.18" X 18.18"	11" X 17"	10.29" X 16.29"	49.69"	Portrait	12.389 lbs	14.37" X 43.70" X 4.02"
						47.72"	Landscape		
UCUMBN0512	UCUMBN0012	UCUMBB0512	19.18" X 23.18"	18" X 22"	17.29" X 21.29"	53.43"	Portrait	15.211 lbs	23.62" X 42.52" X 2.56"
						50.91"	Landscape		



* W:Width H: Height D: Depth

Curved Sign Holder with Acryled



See movie at our website www.mtdisplays.com.tr



Curved Sign Holder with Acryled has both silver & black finish. Curved Sign Holder is suitable to use in hotels, galleries, museums, restaurants, lobby, bars. Available in 8.5" X 11" and 11" X 17" portrait and landscape positions. Special treated acrylic and LED technology illuminates prints homogenous. The edgelit Acryled mounts on Curved Sign Holder both portrait & landscape. Poster placed in position by 2 clear clips on 2 short sides.

All units pass CE/UL PAT test. Packed with quality certificates & 3,5 meter electrical cable. UK and US plugs should be mentioned on order.

Led illumination saves up to 60% energy cost. Heavy base provide stability.

Color options :
Silver-anodized & black

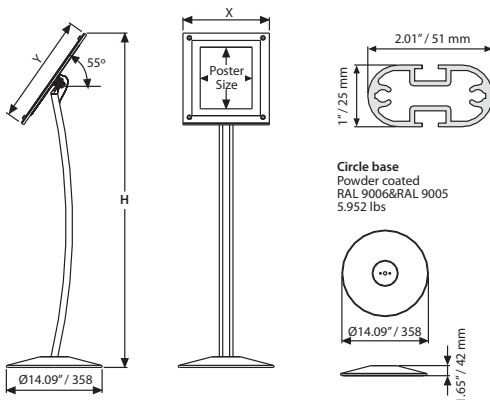

MATERIAL : Silver & Black anodised aluminium							WEIGHT	PACKING SIZE
SILVER	BLACK	EXTERNAL (x-y)	POSTER	COPY	HEIGHT	DESCRIPTION	WITH PACKING	*W X H X D
UCUALN0081	UCUALB0081	12.95" X 16.14"	8.5" X 11"	7.79" X 10.29"	49.21"	Portrait	15.763 lbs	14.37" X 43.70" X 4.02"
					47.83"	Landscape		
UCUALN0017	UCUALB0017	16.14" X 20.98"	11" X 17"	10.259" X 16.29"	51.30"	Portrait	18.408 lbs	30.87" X 53.15" X 4.33"
					49.21"	Landscape		



*W:Width H: Height D: Depth

Universal Showboard on Curved Post



New stylish curved-pole free standing message board captures the customers' attention in all frequented traffic areas. Suitable in use for restaurants, bars, fastfood and more. Very heavy rubberised base keeps Universal Showboard on Curved Post stable. The hidden lock at the side of the frame prevents unnecessary access to poster. Universal Showboard on Curved Post allows portrait or landscape poster to be used on the same unit.

-  Suitable for outdoor use.
-  Stays and magnets included.
-  Adjustable to portrait or landscape position.
-  3 packs. See info chart for pack sizes.

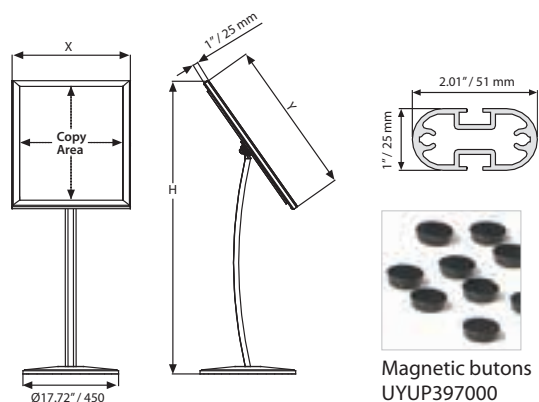

MATERIAL : Silver & Black anodised aluminium						WEIGHT	PACKING SIZE
ARTICLE	EXTERNAL (x-y)	COPY	CAPACITY	DESCRIPTION	HEIGHT	WITH PACKING	*W X H X D
UCUS2B0481	22.05" X 28.74"	19.25" X 25.94"	4 X (8.5" X 11")	Cork	54.33" / portrait	35.714 lbs	2.36" X 41.73" X 3.62"
					51.77" / landscape		19.29" X 19.29" X 0.20"
UCUS3B0481	22.05" X 28.74"	19.25" X 25.94"	4 X (8.5" X 11")	Magnetic	54.33" / portrait	35.714 lbs	2.36" X 41.73" X 3.62"
					51.77" / landscape		19.29" X 19.29" X 0.20"





*W:Width H: Height D: Depth

Paper Board Sign



Snap open design free standing paper holder, Paper Board Sign Holder is provided with two clear clips for each paper. It is practical to change the poster when the message is changed. Heavy rubberised base keeps Paper Board Sign Holder stable. One product can present 4 x (8.5" X 11") letter size. It features complete Black finish which differentiates Paper Board Sign Holder from many others.

 Indoor use.

 Complete with anti-reflex PET cover.

 3 packs. See info chart for pack sizes.

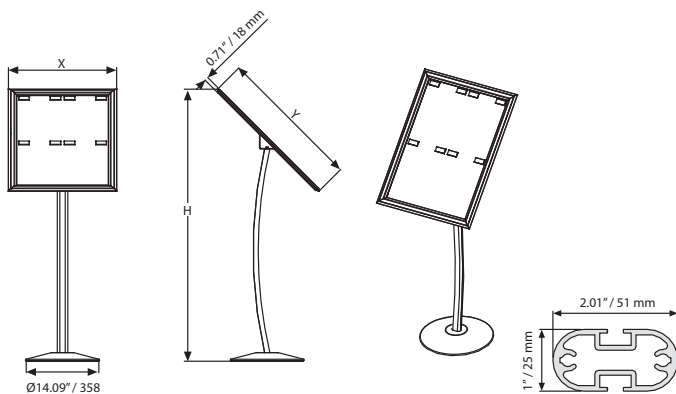

MATERIAL : Silver & Black anodised aluminium					WEIGHT	PACKING SIZE
ARTICLE	EXTERNAL (x-y)	PAPER AREA	CAPACITY	HEIGHT	WITH PACKING	*W X H X D
UCUP0B0481	20.55" X 27.32"	17.40" X 24.17"	4 X (8.5" X 11")	51.57"	23.148 lbs	2.36" X 41.73" X 3.62" 19.29" X 19.29" X 0.20" 23.23" X 29.92" X 2.36"





*W:Width H: Height D: Depth

Classical Sign Holder



The Sign Holder with a sight angle that catches the eye level. It is available in the sizes 8.5" X 11" and 11" X 17" both in landscape & portrait positions.

 Menu boards are packed unassembled with an easy-to-understand instruction sheet & fixing elements.

 Suitable for wet floors.



One product, two positions (landscape & portrait)

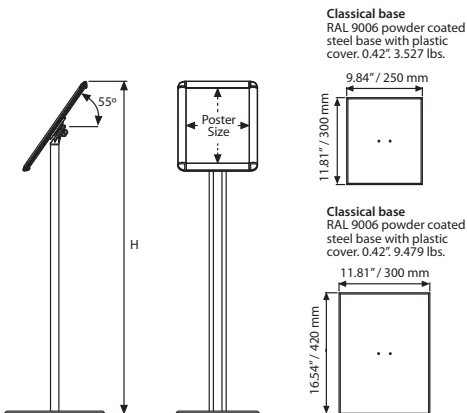

Classical base
RAL 9006 powder coated steel base with plastic cover. 0.42". 3.527 lbs.

Classical base
RAL 9006 powder coated steel base with plastic cover. 0.42". 9.479 lbs.

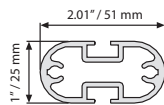

MATERIAL : Silver anodised aluminium							WEIGHT	PACKING SIZE
MITRED ARTICLE	ROUND ARTICLE	EXTERNAL (x-y)	POSTER	COPY	HEIGHT	DESCRIPTION	WITH PACKING	*W X H X D
UCMB1N0581	UCMB1N0081	9.68" X 12.18"	8.5" X 11"	7.79" X 10.29"	38.70"	Portrait	7.495 lbs	11.42" X 38.58" X 2.56"
					38.19"	Landscape		
UCMB1N0517	UCMB1N0017	12.18" X 18.18"	11" X 17"	10.29" X 16.29"	47.72"	Portrait	12.897 lbs	14.96" X 45.28" X 2.56"
					44.61"	Landscape		



*W:Width H: Height D: Depth

Decorative Sign Holder



See movie at our website www.mtdisplays.com.tr



The Sign Holder with a sight angle that catches the eye level. The decorative base provides an elegant look. It is available in the sizes 8.5" X 11" and 11" X 17" in portrait & landscape positions.

Sign Holders are packed unassembled with an easy-to-understand instruction sheet & fixing elements.

Heavy elegant base provides stability.

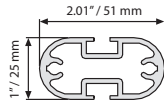
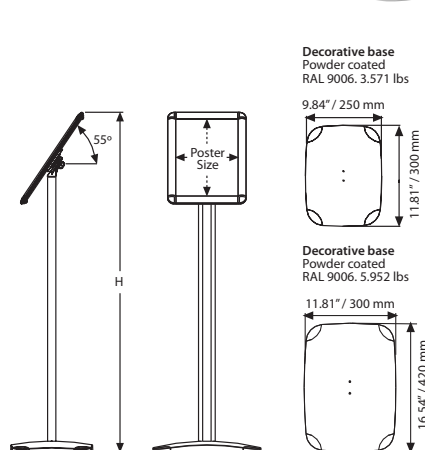

MATERIAL : Silver anodised aluminium PROFILE : 25 mm 45° - 25 mm Round							WEIGHT	PACKING SIZE
MITRED ARTICLE	ROUND ARTICLE	EXTERNAL (x-y)	POSTER	COPY	HEIGHT	DESCRIPTION	WITH PACKING	*W X H X D
UDMB1N05A4	UDMB1N00A4	9.68" X 12.18"	8.5" X 11"	7.79" X 10.29"	39.37"	8.5" x 11" portrait / Silver	8.135 lbs	11.42" X 35.63" X 2.56"
					37.95"	8.5" x 11" landscape / Silver		
UDMB1N05A3	UDMB1N00A3	12.18" X 18.18"	11" X 17"	10.29" X 16.29"	47.24"	11" x 17" portrait / Silver	12.897 lbs	14.96" X 45.28" X 2.56"
					45.28"	11" x 17" landscape / Silver		
UDMB1B05A4	UDMB1B00A4	9.68" X 12.18"	8.5" X 11"	7.79" X 10.29"	39.37"	8.5" x 11" portrait / Black	8.135 lbs	11.42" X 35.63" X 2.56"
					37.95"	8.5" x 11" landscape / Black		
UDMB1B05A3	UDMB1B00A3	12.18" X 18.18"	11" X 17"	10.29" X 16.29"	47.24"	11" x 17" portrait / Black	12.897 lbs	14.96" X 45.28" X 2.56"
					45.28"	11" x 17" landscape / Black		



*W:Width H: Height D: Depth

Adjustable Sign Holder



See movie at our website www.mtdisplays.com.tr



The adjustable single-faced and double-faced menuboards are economic floor stands that can hold up to 3 frames both sided at once. They are easily adjustable to the eye level and suitable for various poster sizes in portrait or landscape options. The decorative base provides an elegant look. The items presented in the sizes 8.5" X 11" and 11"x17" are suitable for portrait & landscape positions. 8.5" X 11" P/L Adjustable menuboard, round corners, max. height 1300mm. 11"x17" P/L Adjustable menuboard, round corners, max. height 59.06".

Sign Holders are packed unassembled with an easy-to-understand instruction sheet & fixing elements.

Supplied with stable heavy base, offers various options.



Some possible variations

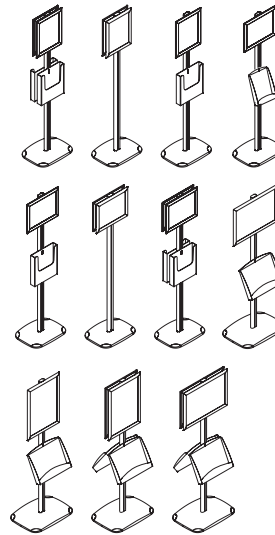

UFSL002100



UFSL003100



UFSL002200



UFSL003200



UFSL003300

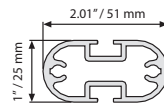
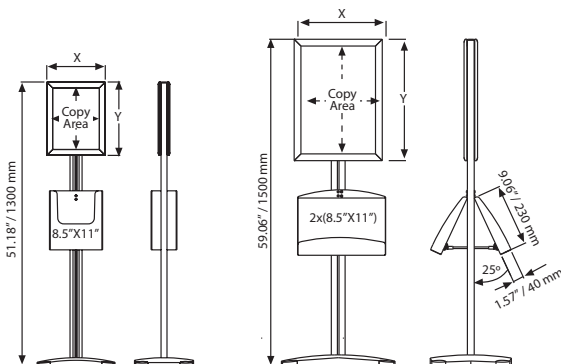

SHELF			WEIGHT	PACKING SIZE
ARTICLE	CAPACITY	DESCRIPTION	WITH PACKING	*W X H X D
UFSL002100	2 X (5.5" X 8.5")	Steel shelf	3.273 lbs	13.39" X 11.42" X 2.48"
UFSL003100	2 X (5.5" X 8.5")	Acrylic shelf	1.962 lbs	13.39" X 11.42" X 2.48"
UFSL002200	1 X (8.5" X 11")	Steel shelf	2.568 lbs	9.84" X 14.57" X 2.48"
UFSL003200	1 X (8.5" X 11")	Acrylic shelf	1.785 lbs	9.84" X 14.57" X 2.48"
UFSL003300	1 X (8.5" X 11")	Acrylic shelf	1.344 lbs	9.45" X 10.63" X 2.17"

MATERIAL : Silver anodised aluminium					WEIGHT	PACKING SIZE
MITRED ARTICLE	ROUND ARTICLE	EXTERNAL (x-y)	POSTER	COPY	WITH PACKING	*W X H X D
UDMB100581	UDMB100081	9.68" X 12.18"	8.5" X 11"	7.79" X 10.29"	9.369 lbs	12.80" X 51.18" X 1.77"
UDMB100517	UDMB100017	12.18" X 18.18"	11" X 17"	10.29" X 16.29"	14.330 lbs	12.80" X 58.66" X 1.77"

*W:Width H:Height D:Depth





Sidewalk Signs

- A Board
- Eco A Board
- Premium A Board with logo
- Premium A Board with Profile logo
- Opti A Board
- Weatherproof A Board
- Write-on A Board
- Slide-in A Board
- Stainless Steel A Board
- Easy Go A Board
- Wood Look A Board

- Street SignPro Board **NEW**
- Street SignPro with Lens **NEW**
- Street SignPro without Lens **NEW**
- SwingPro&WindPro Plus
- SwingPro&WindPro Lite
- BannerPro
- Slide-in WindPro®
- Illuminated WindPro® with LED
- Swingmaster
- Eco Swingmaster
- Waterbase Wind Sign

- Eco Waterbase Wind Sign
- Al Maki
- Rectangular Iron A Board
- Magnetic Iron A Board
- Waterbase Pavement Signs
- PS Boards



A Board



See movie at our website www.mtdisplays.com.tr



Header board and brochure basket options are available. Easy-to-open snap frame includes the anti-reflex cover in all standard A boards. Frame size alternatives are 20"x30", 22"x28" and 30"x40".

- Single packed with an easy-to-understand instruction sheet.
- Heavy back panel provides stability. No tool assembly. Header accessories are not included. Should be ordered separate.
- Each unit has water drainage slots on bottom profiles.

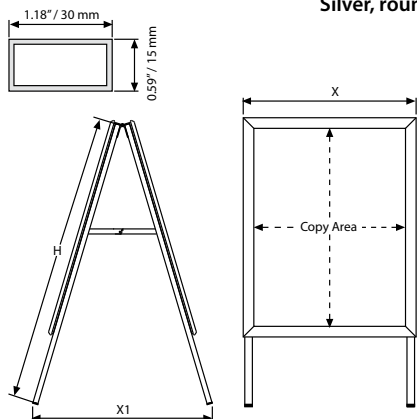

BASKET	WEIGHT	PACKING SIZE
ARTICLE	CAPACITY	*W X H X D
UYTS3000A4	8.27" X 11.69" X 2.57"	1.146 lbs 9.84" X 11.22" X 3.15"

MATERIAL : Silver anodised aluminium									WEIGHT	PACKING SIZE
MITRED SILVER	MITRED BLACK	ROUND SILVER	ROUND BLACK	SAFE CORNER	POSTER	X	X1	H	WITH PACKING	*W X H X D
UAB3250N23	UAB3250B23	UAB3200N23	UAB3200B23	UAB3210N23	20" X 30"	21.69"	27.56"	37.40"	19.841 lbs	25.59" X 44.09" X 4.41"
UAB3250N22	UAB3250B22	UAB3200N22	UAB3200B22	UAB3210N22	22" X 28"	19.69"	27.56"	37.40"	19.841 lbs	27.56" X 42.13" X 4.41"
UAB3250N34	UAB3250B34	UAB3200N34	UAB3200B34	UAB3210N34	30" X 40"	31.69"	33.46"	49.21"	30.423 lbs	31.89" X 50.39" X 4.41"

*W:Width H: Height D: Depth



Eco A Board



A double-sided customer stopper, practical to change the poster within. 22"X28", 24"X36" sizes are available. 1" profile, snap frame. Round or mitred corner options are available. PS backing for indoor use on Eco Indoor A Board whereas galvanized backing for Eco Outdoor A Board. Both are offered with cost-saving mill finished legs.

Single packed with an easy-to-understand instruction sheet. Put on a high palette & eco packaging is used.

! No tool assembly. Each unit has water drainage slots on bottom profile.

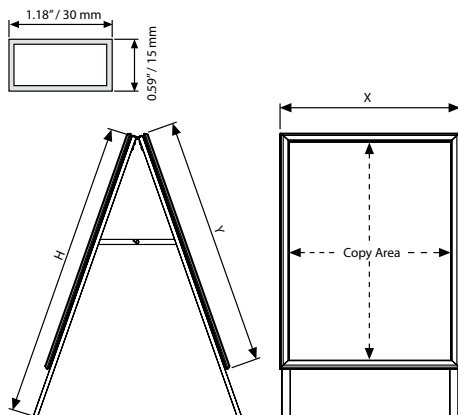

ECO INDOOR A BOARD: PS Backing + Mill Finish Legs PROFILE : 1" / 25 mm							WEIGHT	PACKING SIZE
MITRED ARTICLE	ROUND ARTICLE	POSTER	DESCRIPTION	X	Y	H	WITH PACKING	*W X H X D
UAB255HN22	UAB250HN22	22" X 28"	Silver	21.97"	29.17"	37.40"	12.897 lbs	27.17" X 43.31" X 3.35"
UAB255HN24	UAB250HN24	24" X 36"	Silver	25.20"	37.20"	47.24"	17.306 lbs	27.95" X 54.72" X 3.35"
UAB255HB22	UAB250HB22	22" X 28"	Black	21.97"	29.17"	37.40"	12.897 lbs	27.17" X 43.31" X 3.35"
UAB255HB24	UAB250HB24	24" X 36"	Black	25.20"	37.20"	47.24"	17.306 lbs	27.95" X 54.72" X 3.35"

ECO OUTDOOR A BOARD: Galvanized Backing + Mill Finish Legs PROFILE : 1.26" / 32 mm							WEIGHT	PACKING SIZE
MITRED ARTICLE	ROUND ARTICLE	POSTER	DESCRIPTION	X	Y	H	WITH PACKING	*W X H X D
UAB325HN22	UAB320HN22	22" X 28"	Silver	22.48"	29.69"	37.40"	18.959 lbs	27.17" X 43.31" X 3.35"
UAB325HN24	UAB320HN24	24" X 36"	Silver	25.20"	37.20"	47.24"	23.368 lbs	27.95" X 54.72" X 3.35"
UAB325HB22	UAB320HB22	22" X 28"	Black	22.48"	29.69"	37.40"	18.959 lbs	27.17" X 43.31" X 3.35"
UAB325HB24	UAB320HB24	24" X 36"	Black	25.20"	37.20"	47.24"	23.368 lbs	27.95" X 54.72" X 3.35"

*W:Width H: Height D: Depth



Premium A Board with Logo



See movie at our website www.mtdisplays.com.tr



This heavy duty pavement sign is a perfect use for displaying posters and advertising signs with your own logo. Provides practical use, quick change-poster and logo. The replaceable aluminium composite plate is an ideal spot for a logo or a permanent message, suitable for outdoor conditions. You can print your logo directly or laminate on aluminium composite plate. The frame is hinged for easy transport and storage, with a locking stay to secure when open. Standard in silver anodised, available in standard RAL colours upon request with MOQ.

- Single packed with an easy-to-understand instruction sheet.
- Heavy back panel provides stability. No tool assembly.
- Each unit has water drainage slots on bottom profiles.

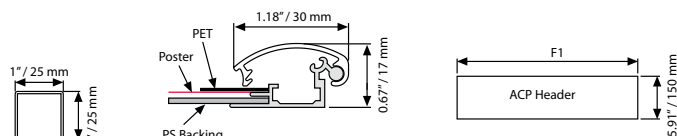
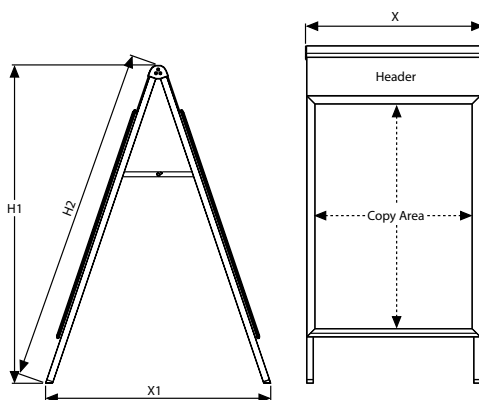

MATERIAL : Silver anodised aluminium									WEIGHT	PACKING SIZE
SILVER	BLACK	POSTER	X	X1	H1	H2	F1	FEET	WITH PACKING	*W X H X D
UAP0305N23	UAP0305B23	20" X 30"	22.01"	30.51"	42.91"	45.67"	21.69"	43.66"	18.739 lbs	24.02" X 47.64" X 4.53"
UAP0305N22	UAP0305B22	22" X 28"	24.06"	32.48"	40.12"	42.68"	23.74"	41.54"	25.132 lbs	25.59" X 46.46" X 4.53"
UAP0305N34	UAP0305B34	30" X 40"	31.01"	37.01"	52.36"	55.51"	31.69"	53.50"	30.423 lbs	34.25" X 57.48" X 4.53"



*W:Width H: Height D: Depth

Premium A Board with Profile Logo



See movie at our website www.mtdisplays.com.tr



This heavy duty pavement sign is a perfect use for displaying posters and advertising signs with your own logo. Provides practical use, quick change-poster and logo. Aluminium profile is an ideal spot for a logo or a permanent message, suitable for outdoor conditions. You can laminate on aluminium header profile. Galvanised steel backing adds extra strength and stability. The frame is hinged for easy transport and storage, with a locking stay to secure when open. Standard in silver anodised, available in standard RAL colours upon request with MOQ.

Single packed with an easy-to-understand instruction sheet.

Heavy back panel provides stability. No tool assembly. Each unit has water drainage slots on bottom profiles.

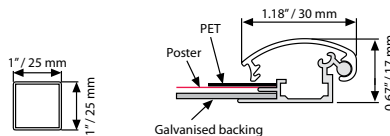
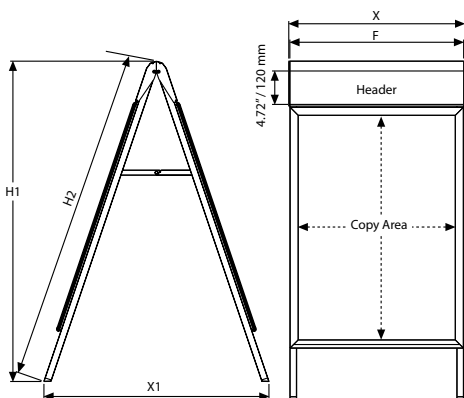

MATERIAL : Silver anodised aluminium

SILVER	BLACK	POSTER	HEADER PRINTING	X	X1	H1	H2	F1	FEET
UAP1305N23	UAP1305B23	20" X 30"	20" X 4.72"	22.01"	30.51"	42.91"	45.67"	21.69"	43.66"
UAP1305N34	UAP1305B34	30" X 40"	30" X 4.72"	32.01"	37.01"	52.36"	55.51"	31.69"	53.50"
UAP1305N22	UAP1305B22	22" X 28"	22" X 4.72"	22.20"	28.94"	40.55"	43.11"	21.89"	41.10"

WEIGHT	PACKING SIZE
WITH PACKING	*W X H X D
18.739 lbs	24.02" X 47.64" X 4.53"
30.423 lbs	34.25" X 57.48" X 4.53"
18.408 lbs	23.62" X 45.28" X 4.53"

*W:Width H: Height D: Depth



Opti Frame A Board



A new design for pavement sign needs! In our new opti family, we have just created a fresh design as a classical pavement sign A Board. This new product will not only offer new performance but also comes with competitive offers to support its distribution growth among all other pavement signs in the market. Provided with 1" profiles; only available in 22"X28" size. Mitred and round corners are available, backing in PS is standard.

- Single packed with an easy instruction sheet. Placed over high pallet and provided with eco packaging.
- Rounded and safe mitred corners suit the product to health&safety conditions.
- Mill finish legs require fitting on holes by the receiver. Each unit has water drainage slots on bottom profiles.

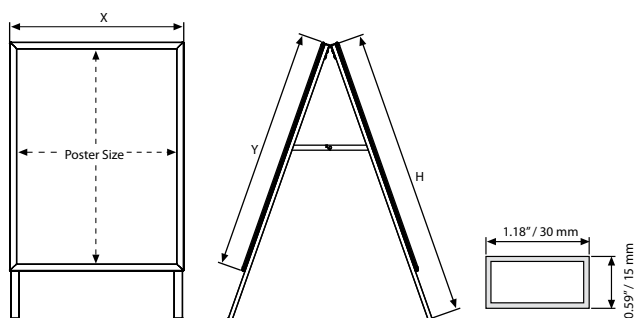

MATERIAL : Silver anodised aluminium PROFILE : 1" / 25 mm profile						WEIGHT	PACKING SIZE
MITRED ARTICLE	ROUND ARTICLE	POSTER	X	Y	H	WITH PACKING	*W X H X D
UOAB255N22	UOAB250N22	22" X 28"	23.39"	29.33"	37.40"	14.109 lbs	26.77" X 43.31" X 3.35"

*W:Width H: Height D: Depth



Weatherproof A Board



1.38" weatherproof. Suitable for use under rainy outdoor conditions. When poster is placed inside the water wick, it is protected, weatherproof. Header board and brochure basket options are present. Easy-to-open snap frame includes the anti-reflex cover in all standard A boards. Frame size alternatives are 20"x30", 30"x40" mm.

Single packed with an easy mounting instruction sheet.

No tool assembly. Header accessories are not included. Should be ordered separate.

Each unit has water drainage slots on bottom profiles. Please use pull sticker to take off cover.

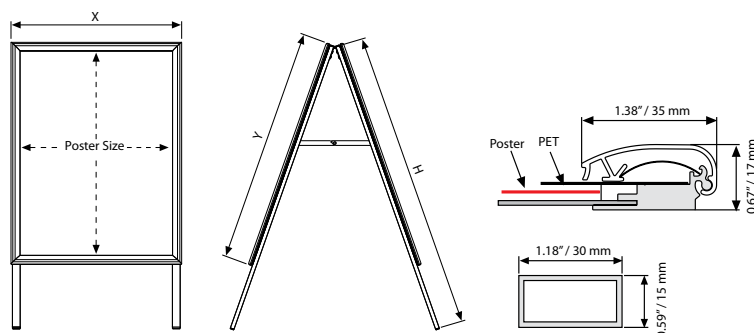

MATERIAL : Silver anodised aluminium					WEIGHT	PACKING SIZE
ARTICLE	POSTER	X	Y	H	WITH PACKING	*W X H X D
UAB3550N22	22" X 28"	24.49"	28.86"	37.40"	17.636 lbs	25.39" X 41.34" X 4.33"



*W:Width H: Height D: Depth

Write-on A Board



See movie at our website www.mtdisplays.com.tr



Write-on A Boards are for use with water-base chalkpens and removable boardmarkers. The board is rigid and weatherproof. We sell pens individually and in sets Indoor and outdoor use. Anodised aluminium, stylish and durable.

 Single packed with an easy mounting instruction sheet.

 No tool assembly.



Legs silver-white surface without header



Legs silver-white surface with header



Legs black-white surface without header



Legs black-white surface with header



Don't forget to order
Chalkboard Marker
UYAKLM1251 - Colour Marker
UYAKLM1250 - White Marker

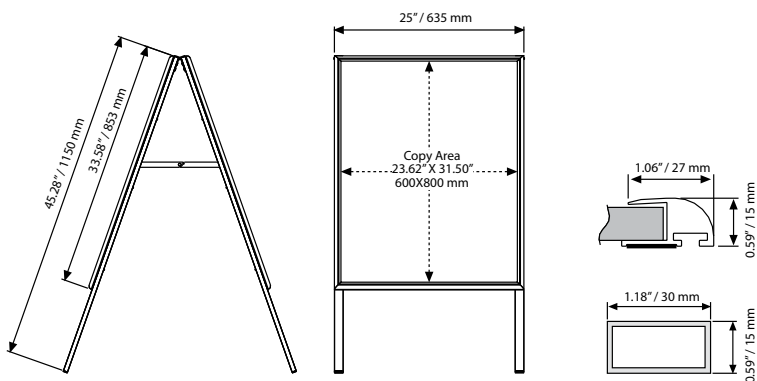

MATERIAL : Silver anodised aluminium			WEIGHT	PACKING SIZE
ARTICLE	POSTER	DESCRIPTION	WITH PACKING	*W X H X D
UWABONW022	22" X 28"	Silver-White / without header	16.975 lbs	26.77" X 50" X 3.35"
UWABOBW022	22" X 28"	Black-White / without header	16.975 lbs	26.77" X 50" X 3.35"
UWABONW122	22" X 28"	Silver-White / with header	16.975 lbs	26.77" X 50" X 3.35"
UWABOBW122	22" X 28"	Black-White / with header	16.975 lbs	26.77" X 50" X 3.35"

* W:Width H: Height D: Depth





Slide-in A Board



See movie at our website www.mtdisplays.com.tr



Top opening Slide-in A Board is a practical product. Suitable for outdoor use. Available in Grey and Black finishes. Poster stands stable in between cover and backing. Rubber feet increase the product life as well as giving a clean finish to Slide-in A Board.

-  Single packed with an easy mounting instruction sheet.
-  Bottom profile of sandwich slide-in panel provide easy application.
-  No tool assembly.

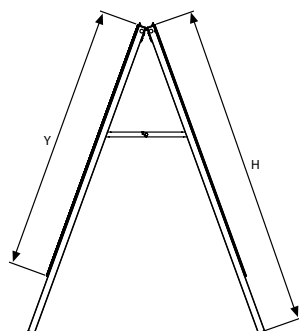
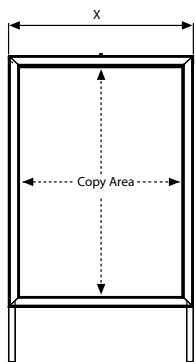
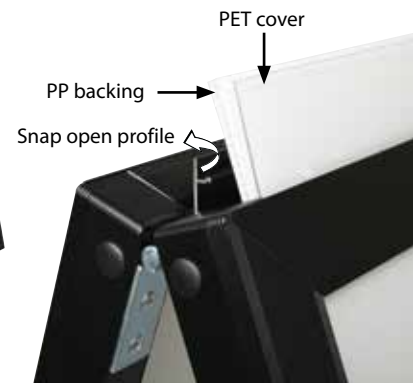
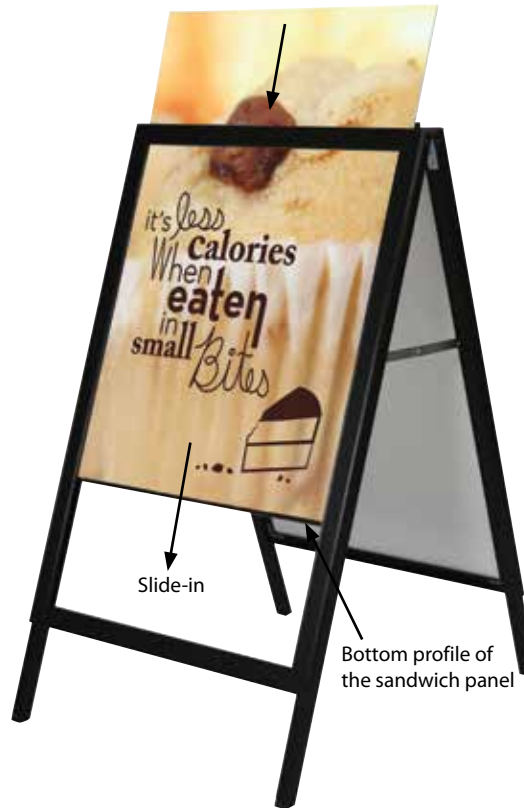

FRAME : Powder coated aluminium						WEIGHT	PACKING SIZE
GRAY	BLACK	EXTERNAL (x-y)	POSTER	COPY	H	WITH PACKING	*W X H X D
UABSON0022	UABS0B0022	24.24" X 30.24"	22" X 28"	21.09" X 27.09"	45.28"	16.314 lbs	25.59" X 38.98" X 3.35"
UABSON0024	UABS0B0024	26.24" X 38.24"	24" X 36"	23.09" X 35.09"	45.28"	23.765 lbs	28.35" X 50" X 3.35"
UABSON0034	UABS0B0034	32.24" X 42.24"	30" X 40"	29.09" X 39.09"	49.21"	23.258 lbs	34.65" X 53.94" X 3.35"





*W:Width H: Height D: Depth

Stainless Steel A Board



Write-on A Boards are for use with water-base chalkpens and removable boardmarkers. The board is rigid and weatherproof. We sell pens individually and in sets. Indoor and outdoor use. Stainless steel, stylish and durable.

-  Single packed with an easy mounting instruction sheet.
-  No tool assembly.

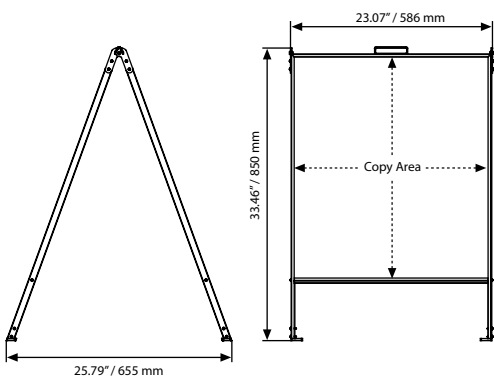

Don't forget to order
Chalkboard Marker
UYAKLM1251 - Colour Marker
UYAKLM1250 - White Marker

MATERIAL : Steel				WEIGHT	PACKING SIZE
ARTICLE	POSTER	COPY AREA	DESCRIPTION	WITH PACKING	*W X H X D
USWAB00022	22" X 28"	22.13" X 26.89"	Write - on A Board	10.582 lbs	25.20" X 37.80" X 2.95"
USCAB00022	22" X 28"	22.13" X 26.89"	Chalk A Board	9.590 lbs	25.20" X 37.80" X 2.95"



*W:Width H: Height D: Depth



Easy Go A Board



See movie at our website www.mtdisplays.com.tr



Easy go A Board is an ultraportable and easy to use model in A board range. With its unique foldable design, it is easy to carry and set up. There are 3 different panels that can be used in this model; chalkpanel, write-on panel, PVC Foam panel for direct printing. These panels will be slid into the channels of the legs. Suitable for max. 6 mm panels.

-  Unique foldable design. Easy to carry and set up.
-  No tool assembly.
-  Panels excluded. Order separately.

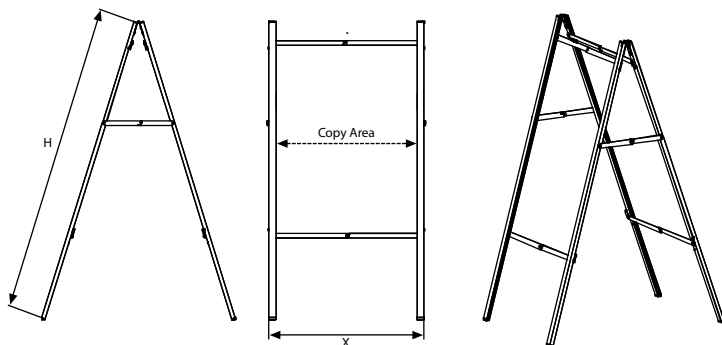
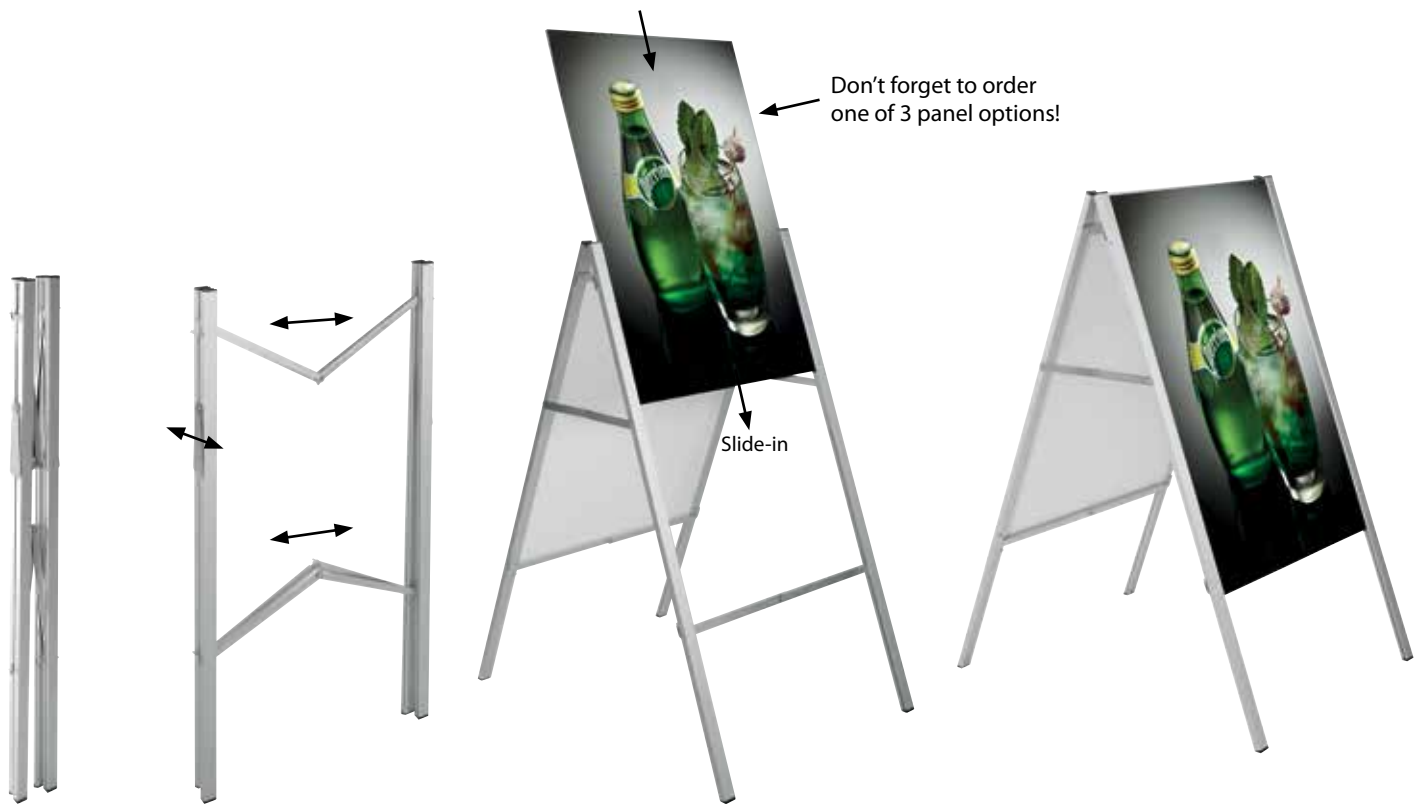

PANELS				WEIGHT	PACKING SIZE
CHALK PANEL	WRITE-ON PANEL	PVC FOAM PANEL	SIZE	WITH PACKING	*W X H X D
UYPEG10022	UYPEG20022	UYPEG30022	22.01" X 27.99"	11.243 lbs	4.53" X 40.16" X 2.56"
UYPEG10024	UYPEG20024	UYPEG30024	24.02" X 35.98"	13.227 lbs	4.53" X 48.03" X 2.56"

MATERIAL: Silver anodised aluminium - without panel					WEIGHT	PACKING SIZE
ARTICLE	POSTER	COPY	X	H	WITH PACKING	*W X H X D
UABEG00N22	22" X 28"	21.30" X 27.99"	23.58"	37.40"	11.243 lbs	4.53" X 40.16" X 2.56"
UABEG00N24	24" X 36"	23.31" X 35.98"	25.59"	45.28"	13.227 lbs	4.53" X 48.03" X 2.56"

*W:Width H: Height D: Depth



Wood Look A Board



Wood Look A Board has aluminum profiles like standard A Boards but with wood look. It has a higher durability compared to real wood products. Standard or custom shape header is available for personalization. 23.62"x31.50" writing area can be used with both chalk or water base chalk marker. This is the right product for customers looking for warmth of wood look and durability.

 Single packed with an easy mounting instruction sheet.

 No tool assembly.

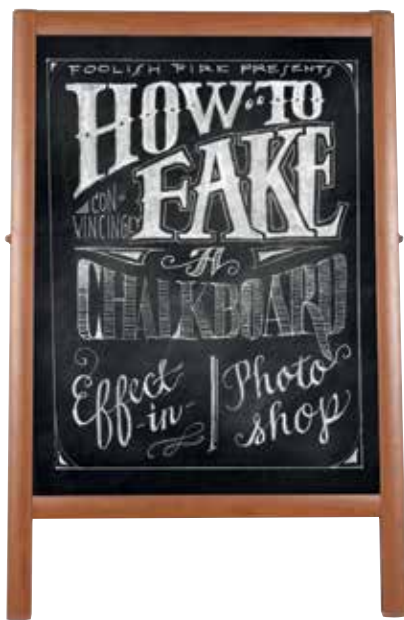

Decorative header is optional accessories.



Headers are optional accessories.

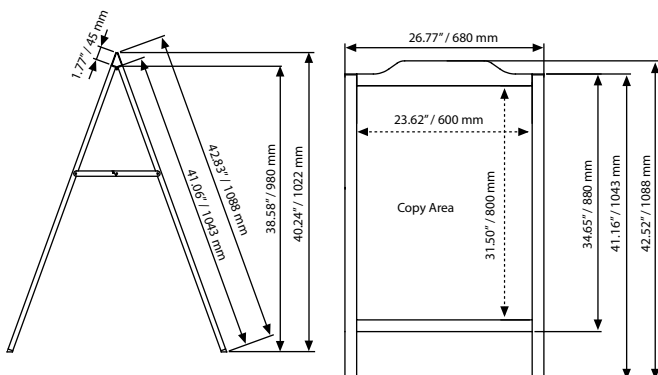
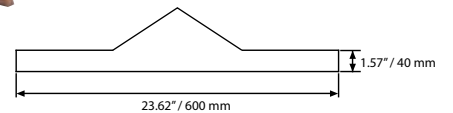
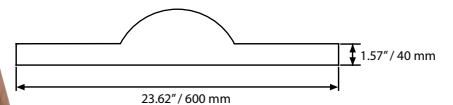
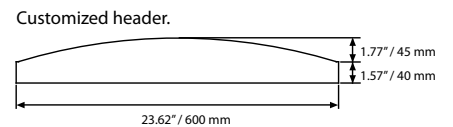
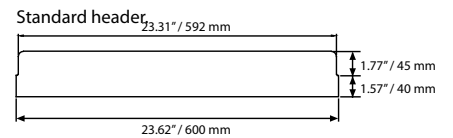
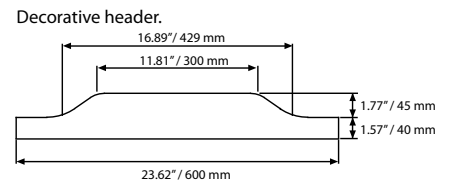

Don't forget to order
Chalkboard Marker
UYAKLM1251 - Colour Marker
UYAKLM1250 - White Marker

MATERIAL : Aluminium			WEIGHT	PACKING SIZE
ARTICLE	COPY AREA	DESCRIPTION	WITH PACKING	*W X H X D
UAWL000022	22" X 28"	without header	16.424 lbs	28.35" X 44.49" X 2.76"
UAWL100024	24" X 36"	with decorative header	20.106 lbs	30.31" X 49.21" X 2.76"

*W:Width H: Height D: Depth



Street SignPro Board

new



See movie at our website www.mtdisplays.com.tr

Made of durable plastic, Street SignPro Board is outdoor double sided sign frame which holds two signs in size of 24" (W) x 36"(H). Recessed sign area helps to protect poster faces. It is built with a molded-in handle for easy transport. Equipped with scissors on both sides, so SignPro does not slide and damaging sign faces. It is foldable for space saving in storage. No need to fill up with water or sand as it is already constructed with heavy materials. It is available in White, Black and Grey. Street SignPro Board is for laminating self-adhesive sticker.

Max poster thickness is 5mm.

Self-adhesive sticker is recommended with surface preparation.

Optional well nuts is available. 6 well nuts recommended per sign frame, total 12 well nuts per Street SignPro Board.

Color options



Street SignPro Board - Black



Street SignPro Board - White

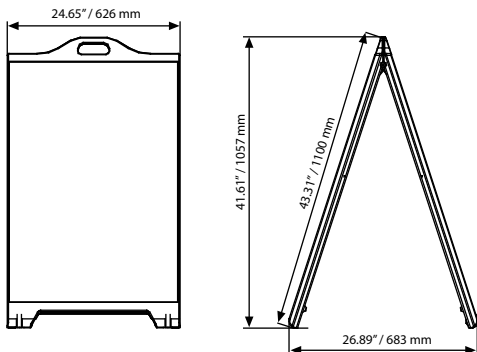

Optional well nuts (12 Pcs) UYSP00010X1000

Patent No: PCT/EP2017/052765

MATERIAL : PE				WEIGHT	PACKING SIZE
WHITE	BLACK	SIZE	COPY SIZE	WITH PACKING	*W X H X D
UPSP310024	UPSP320024	24" X 36"	24" X 36"	29.982 lbs	27.95" X 47.24" X 4.33"

*W:Width H:Height D:Depth



Street SignPro Poster with Lens

new



See movie at our website www.mtdisplays.com.tr

Made of durable plastic, Street SignPro Poster with Lens is outdoor double sided sign frame which holds two signs in size of 24" (W) x 36"(H). Recessed sign area helps to protect poster faces. It is built with a molded-in handle for easy transport. Equipped with scissors on both sides, so SignPro does not slide and damaging sign faces. It is foldable for space saving in storage. No need to fill up with water or sand as it is already constructed with heavy materials. It is available in White, Black and Grey. Street SignPro Frame with lens has a frame with anti-reflex graphic protection. This unique feature helps keeping the graphic in place sturdily. Frame is locked with hidden locking to avoid unnecessary access to poster.

Max poster thickness is 0,2 mm.

No tool assembly.

Color options



Street SignPro Poster with Lens- Black



Street SignPro Poster with Lens- White

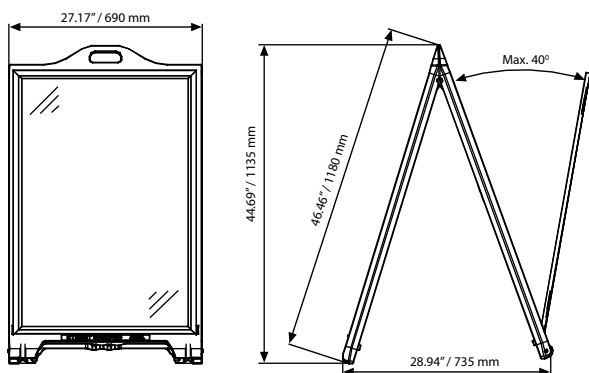

Patent No: PCT/EP2017/052765

MATERIAL : PE				WEIGHT	PACKING SIZE
WHITE	BLACK	SIZE	COPY SIZE	WITH PACKING	*W X H X D
UPSP110024	UPSP120024	24" X 36"	23.39" X 35.43"	37.037 lbs	27.95" X 47.24" X 4.33"

*W:Width H:Height D:Depth



Street SignPro Poster without Lens

new



See movie at our website www.mtdisplays.com.tr

Made of durable plastic, Street SignPro Poster without Lens is outdoor double sided sign frame which holds two signs in size of 24" (W) x 36" (H). Recessed sign area helps to protect poster faces. It is built with a molded-in handle for easy transport. Equipped with scissors on both sides, so SignPro does not slide and damaging sign faces. It is foldable for space saving in storage. No need to fill up with water or sand as it is already constructed with heavy materials. It is available in White, Black and Grey. Street SignPro Frame without lens allows using rigid graphic. This unique feature helps keeping the graphic in place sturdily. Frame is locked with hidden locking to avoid unnecessary access to rigid poster.

Max poster thickness is 5 mm.

No tool assembly.

Color options



Street SignPro Poster without Lens - White



Street SignPro Poster without Lens - Black

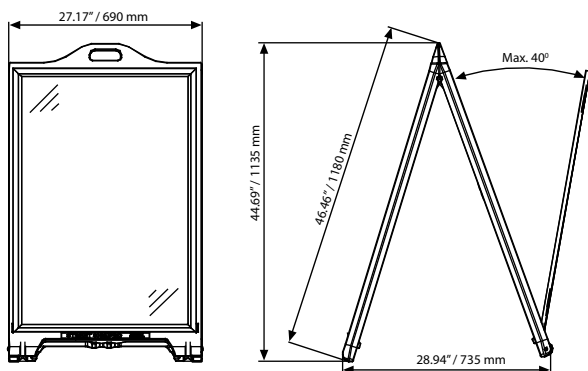

Patent No: PCT/EP2017/052765

MATERIAL : PE				WEIGHT	PACKING SIZE
WHITE	BLACK	SIZE	COPY SIZE	WITH PACKING	*W X H X D
UPSP210024	UPSP220024	24" X 36"	23.23" X 35.35"	32.738 lbs	27.95" X 47.24" X 4.33"

*W:Width H:Height D:Depth



SwingPro® Plus



See movie at our website www.mtdisplays.com.tr

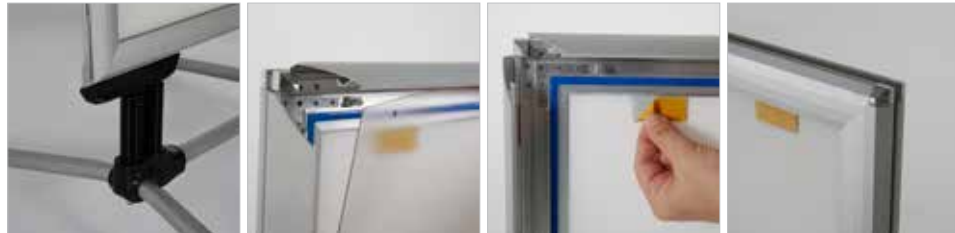

With increase performance, SwingPro® Plus is more durable against outdoor conditions. It consists of 2 main articles: frame and the base. The gasket in frame provides high vacuuming to UV resistant poster protection to keep the poster dry. PET is fixed on the top profile to help easy poster change. The poster stickers which is suitable for re-use upto 100 times are also keep the poster in place avoid sliding down the frame get wet. No sharp edges and has steel springs for flexibility. Poster use is double sided.

Base standard in dark grey color or black. Other colors are available upon request. Ground wheels in upside position enable easy movement of the product.

Please note that if the frame of SwingPro Plus and WindPro Plus is required with a "HEADER" option, then the standard articles cannot be used, please contact our sales department for the articles with a header option.
Please place the poster on stickers inside the water wick around the inner frame.

Do not forget to order carry tool.

Assembly in 65-75 seconds.

1.73" / 44 mm design profile

Strong PP backing

1.30" / 33 mm depth

WEATHERPROOF IP56

WIND RESISTANT

Newtech Waterbase

Stell Base

Patent No: OHIM DM/084 128

One top goes with 2 different bases.

Snap open

Safe corner

Clear cover hanger

Adhesive poster tape

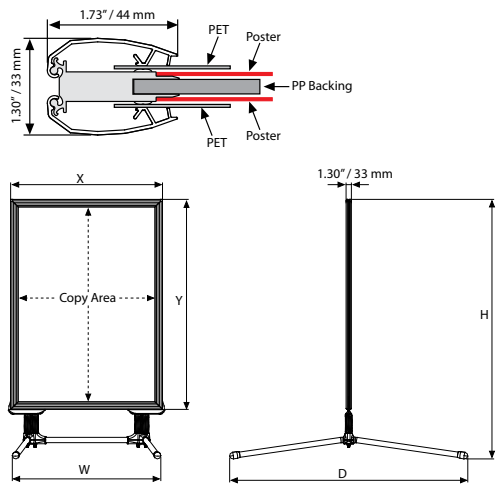

STEEL BASE : Silver anodised aluminium							WEIGHT	PACKING SIZE
SILVER	BLACK	SIZE	FOR	H	W	D	WITH PACKING	*W X H X D
UTSM001000	UTSM001010	36.22"	20"X30"	44.84"	27.17"	36.22"	7.716 lbs	8.66" X 38.19" X 1.85"
			22"X28"	42.83"	27.17"	36.22"	7.716 lbs	8.66" X 38.19" X 1.85"
UTSM002000	UTSM002010	42.13"	24"X36"	50.87"	27.17"	42.13"	8.818 lbs	8.66" X 46.46" X 1.85"
UTSM003000	UTSM003010	49.61"	30"X40"	54.21"	35.04"	49.61"	10.141 lbs	8.66" X 51.57" X 1.85"
			FO	62.09"	35.04"	55.91"	10.141 lbs	8.66" X 51.57" X 1.85"

FRAME : Powder coated steel						WEIGHT	PACKING SIZE
SILVER	BLACK	EXTERNAL (x-y)	POSTER	COPY		WITH PACKING	*W X H X D
USWPP00N22	USWPP00N22	25.03" X 31.03"	22" X 28"	21.53" X 27.53"		17.526 lbs	26.18" X 40.55" X 1.57"
USWPP00N23	USWPP00N23	23.03" X 33.03"	20" X 30"	19.53" X 29.53"		17.526 lbs	24.21" X 43.31" X 1.57"
USWPP00N24	USWPP00N24	27.03" X 39.03"	24" X 36"	23.53" X 35.53"		19.731 lbs	27.95" X 48.82" X 1.57"
USWPP00N34	USWPP00N34	33.03" X 43.03"	30" X 40"	29.53" X 39.53"		24.912 lbs	34.45" X 53.15" X 1.57"
USWPP00NFO	USWPP00NFO	36.14" X 55.04"	FO	32.64" X 51.54"		28.660 lbs	34.65" X 59.06" X 1.57"

*W:Width H: Height D: Depth



WindPro® Plus



See movie at our website www.mtdisplays.com.tr



With increase performance, WindPro® Plus is more durable against outdoor conditions. It consists of 2 main articles: frame and the base. The gasket in frame provides high vacuuming to UV resistant poster protection to keep the poster dry. PET is fixed on the top profile to help easy poster change. The poster stickers which is suitable for re-use upto 100 times are also keep the poster in place avoid sliding down the frame get wet. No sharp edges and has steel springs for flexibility. Poster use is double sided.

Base standard in dark grey color or black. Other colors are available upon request. Ground wheels in upside position enable easy movement of the product.

Please note that if the frame of SwingPro Plus and WindPro Plus is required with a "HEADER" option, then the standard articles cannot be used, please contact our sales department for the articles with a header option. Please place the poster on stickers inside the water wick around the inner frame.

Do not forget to order carry tool.

Assembly in 65-75 seconds.

UYUP480945
Optional
carry tool.



One top goes with 2 different bases.

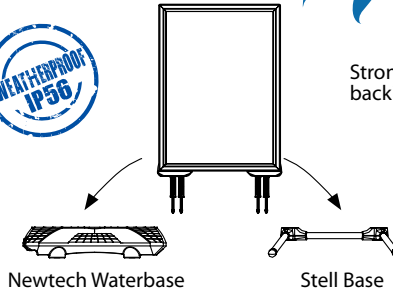

Patent No: OHIM DM/084 128

Snap open

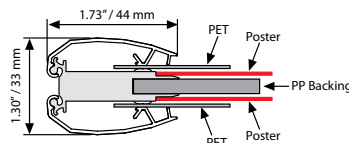
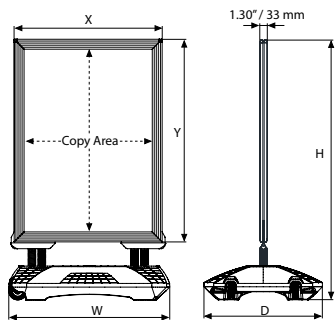

NEWTECH WATER BASE: HLDPE							WEIGHT	PACKING SIZE
SILVER	BLACK	SIZE	FOR	H	W	D	WITH PACKING	*W X H X D
UTWM003000	UTWM003010	28.35" X 20.87"	20" X 30"	42.87"	28.35"	20.87"	9.876 lbs	21.85" X 29.53" X 7.01"
			22" X 28"	40.87"	28.35"	20.87"		
			24" X 36"	48.90"	28.35"	20.87"		
UTWM004000	UTWM004010	35.43" X 24.80"	30" X 40"	52.87"	35.43"	24.80"	15.101 lbs	23.82" X 36.61" X 7.01"
			F0	48.90"	35.43"	24.80"		

FRAME : Powder coated steel						WEIGHT	PACKING SIZE
SILVER	BLACK	EXTERNAL (x-y)	POSTER	COPY		WITH PACKING	*W X H X D
USWPP00N22	USWPP00N22	25.03" X 31.03"	22" X 28"	21.53" X 27.53"		17.526 lbs	26.18" X 40.55" X 1.57"
USWPP00N23	USWPP00N23	23.03" X 33.03"	20" X 30"	19.53" X 29.53"		17.526 lbs	24.21" X 43.31" X 1.57"
USWPP00N24	USWPP00N24	27.03" X 39.03"	24" X 36"	23.53" X 35.53"		19.731 lbs	27.95" X 48.82" X 1.57"
USWPP00N34	USWPP00N34	33.03" X 43.03"	30" X 40"	29.53" X 39.53"		24.912 lbs	34.45" X 53.15" X 1.57"
USWPP00NFO	USWPP00NFO	36.14" X 55.04"	F0	32.64" X 51.54"		28.660 lbs	34.65" X 59.06" X 1.57"

*W:Width H: Height D: Depth



SwingPro® Lite



See movie at our website www.mtdisplays.com.tr



SwingPro® Lite is heavy and robust waterbase pavement sign for outdoor. It consists of 2 main articles: frame and the base. No sharp edges and has steel springs for flexibility. Poster use is double sided. Recommended to use film posters.

Base standard in dark grey color or black. Other colors are available upon request. Ground wheels in upside position enable easy movement of the product.

Please note that if the frame of SwingPro Plus and WindPro Plus is required with a "HEADER" option, then the standard articles cannot be used, please contact our sales department for the articles with a header option.
Please place the poster on stickers inside the water wick around the inner frame.

Do not forget to order carry tool.

Assembly in 65-75 seconds.

Patent No: OHIM DM/084 128

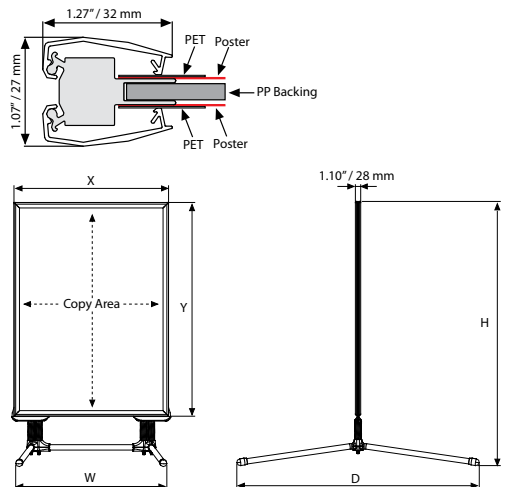

STEEL BASE : Silver anodised aluminium							WEIGHT	PACKING SIZE
SILVER	BLACK	SIZE	FOR	H	W	D	WITH PACKING	*W X H X D
UTSM001000	UTSM001010	36.22"	22" X 28"	41.30"	27.17"	36.22"	7.716 lbs	8.66" X 38.19" X 1.85"
UTSM002000	UTSM002010	42.13"	24" X 36"	49.33"	27.17"	42.13"	8.818 lbs	8.66" X 46.46" X 1.85"
UTSM003000	UTSM003010	49.61"	28" X 44"	57.28"	35.04"	49.61"	10.141 lbs	8.66" X 51.57" X 1.85"
			30" X 40"	53.31"	35.04"	49.61"	10.141 lbs	8.66" X 51.57" X 1.85"

FRAME : Silver anodised aluminium					WEIGHT	PACKING SIZE
SILVER	BLACK	EXTERNAL (x-y)	POSTER	COPY	WITH PACKING	*W X H X D
USWPL00N22	USWPL00B22	23.50" X 29.49"	22" X 28"	20.98" X 26.98"	12.015 lbs	25.39" X 39.76" X 1.38"
USWPL00N24	USWPL00B24	25.51" X 37.52"	24" X 36"	22.98" X 34.98"	14.418 lbs	27.17" X 47.83" X 1.38"
USWPL00N34	USWPL00B34	31.50" X 41.50"	30" X 40"	28.98" X 38.98"	18.739 lbs	33.27" X 51.77" X 1.38"
USWPL00N84	USWPL00B84	29.50" X 45.50"	28" X 44"	26.98" X 42.98"	19.841 lbs	31.30" X 55.71" X 1.38"

*W:Width H: Height D: Depth



WindPro® Lite



See movie at our website www.mtdisplays.com.tr



WindPro® Lite is heavy and robust waterbase pavement sign for outdoor. It consists of 2 main articles: frame and the base. No sharp edges and has steel springs for flexibility. Poster use is double sided. Recommended to use film posters.

Base standard in dark grey color or black. Other colors are available upon request. Ground wheels in upside position enable easy movement of the product.

Please note that if the frame of SwingPro Plus and WindPro Plus is required with a "HEADER" option, then the standard articles cannot be used, please contact our sales department for the articles with a header option. Please place the poster on stickers inside the water wick around the inner frame.

Do not forget to order carry tool.

Assembly in 65-75 seconds.

One top goes with 2 different bases.

Strong PP backing

UYUP480945 Optional carry tool.

Patent No: OHIM DM/084 128

Snap open

Safe corner

1.30" / 33 mm design profile

WEATHERPROOF IP56

WIND RESISTANT

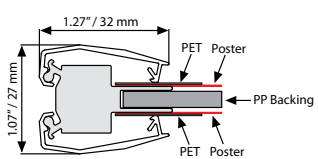
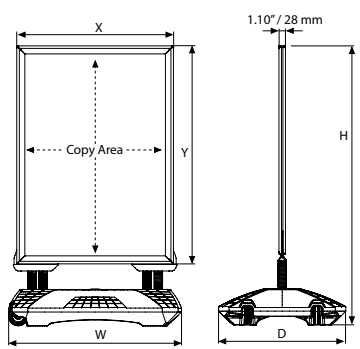

NEWTECH WATERBASE : HLDPE							WEIGHT	PACKING SIZE
SILVER	BLACK	SIZE	FOR	H	W	D	WITH PACKING	*W X H X D
UTWM003000	UTWM003010	28.35" X 20.87"	22" X 28"	39.33"	28.35"	20.87"	9.876 lbs	21.85" X 29.53" X 7.01"
			24" X 36"	47.36"	28.35"	20.87"		
UTWM004000	UTWM04010	35.43" X 24.80"	28" X 44"	55.31"	35.43"	24.80"	15.101 lbs	23.82" X 36.61" X 7.01"
			30" X 40"	51.34"	35.43"	24.80"		

FRAME : Silver anodised aluminium						WEIGHT	PACKING SIZE
SILVER	BLACK	EXTERNAL (x-y)	POSTER	COPY		WITH PACKING	*W X H X D
USWPLOON22	USWPLOOB22	23.50" X 29.49"	22" X 28"	20.98" X 26.98"		12.015 lbs	25.39" X 39.76" X 1.38"
USWPLOON24	USWPLOOB24	25.51" X 37.52"	24" X 36"	22.98" X 34.98"		14.418 lbs	27.17" X 47.83" X 1.38"
USWPLOON34	USWPLOOB34	31.50" X 41.50"	30" X 40"	28.98" X 38.98"		18.739 lbs	33.27" X 51.77" X 1.38"
USWPLOON84	USWPLOOB84	29.50" X 45.50"	28" X 44"	26.98" X 42.98"		19.841 lbs	31.30" X 55.71" X 1.38"

*W:Width H: Height D: Depth





BannerPro



Reasonably priced and practical BannerPro is suitable for outdoor use. Solid finish on the iron profiles provide elegant image to product. O rings included in the product.

 Suitable for windy outdoor conditions. Packed unassembled.

 Stain free outdoor powder coating.

 Available in Silver and Black as standard.

Color options:



UYUP480945
Optional carry tool.
Pulling force
13,227"-
17,636" max.

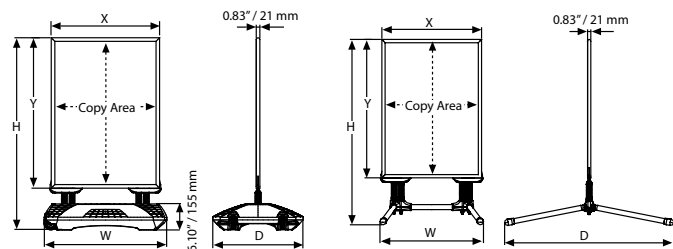

FRAME : Powder coated aluminium				WEIGHT	PACKING SIZE
SILVER	BLACK	EXTERNAL (x-y)	POSTER	WITH PACKING	*W X H X D
UBPON00024	UBPOB00024	25.73" X 37.73"	24" X 36"	11.287 lbs	28.35" X 50" X 1.85"
UBPON00034	UBPOB00034	31.73" X 41.73"	30" X 40"	16.358 lbs	35.04" X 53.94" X 1.85"

STEEL BASE : Powder coated aluminium						WEIGHT	PACKING SIZE
SILVER	BLACK	FOR	H	W	D	WITH PACKING	*W X H X D
UTSM002000	UTSM002010	24" X 36"	50.63"	27.17"	42.13"	12.345 lbs	8.66" X 46.46" X 1.85"
UTSM003000	UTSM003010	30" X 40"	54.65"	35.04"	49.61"	10.141 lbs	8.66" X 51.57" X 1.85"

NEWTECH WATERBASE : HDPE						WEIGHT	PACKING SIZE
SILVER	BLACK	FOR	H	W	D	WITH PACKING	*W X H X D
UTWM003000	UTWM003010	24" X 36"	48.46"	28.35"	20.87"	9.876 lbs	21.85" X 29.53" X 7.01"
UTWM004000	UTWM004010	30" X 40"	52.48"	35.43"	24.80"	15.101 lbs	23.82" X 36.61" X 7.01"



*W:Width H: Height D: Depth

Slide-in SwingPro® & WindPro®



Top opening Slide-in WindPro® is a well designed outdoor product. Poster is secured in the lockable frame and stands firm between the cover and backing. Safe corners of the frame complies health and safety regulations. The springs stabilize the poster and frame in outdoor conditions.

- Single packed in 2 boxes with an easy mounting instruction sheet.
- Bottom profile of sandwich slide-in panel provide easy application.
- Heavy long feet on the base provide stability.

Color options:
 Silver
 Black

UYUP480945
Optional carry tool.
Pulling force
13,227" - 17,636" max.



One top goes with 2 different bases.

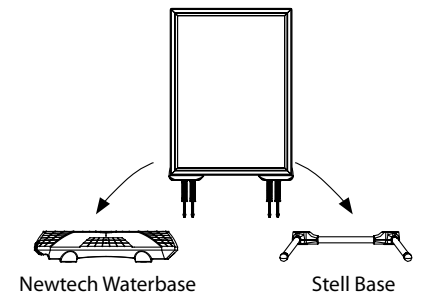

Patent No: OHIM DM/084 128

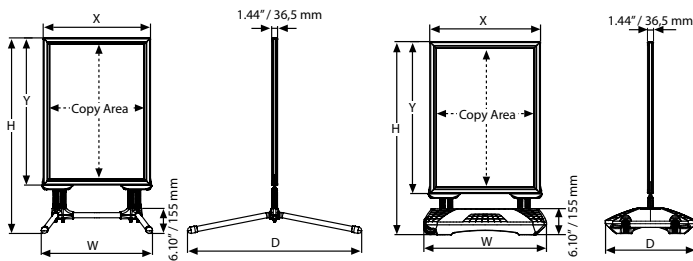

FRAME : Silver anodised aluminium					WEIGHT	PACKING SIZE
SILVER	BLACK	EXTERNAL (x-y)	POSTER	COPY	WITH PACKING	*W X H X D
USWS000N22	USWS000B28	24.84" X 30.83"	22" X 28"	21.69" X 27.68"	17.868 lbs	26.77" X 41.34" X 1.85"
USWS000N24	USWS000B24	26.85" X 38.82"	24" X 36"	23.70" X 35.67"	21.142 lbs	29.53" X 50" X 1.85"
USWS000N74	USWS000B74	29.84" X 42.83"	27" X 40"	26.69" X 39.69"	24.890 lbs	32.28" X 52.76" X 1.85"

STEEL BASE : Powder coated aluminium							WEIGHT	PACKING SIZE
SILVER	BLACK	FOR	H	W	D	WITH PACKING	*W X H X D	
UTSM002000	UTSM002010	22" X 28"	42.64"	27.17"	42.13"	8.818 lbs	8.66" X 46.46" X 1.85"	
UTSM002000	UTSM002010	24" X 36"	50.63"	27.17"	42.13"	12.345 lbs	8.66" X 46.46" X 1.85"	
UTSM003000	UTSM003010	30" X 40"	54.65"	35.04"	49.61"	10.141 lbs	8.66" X 51.57" X 1.85"	

NEWTECH WATERBASE : HLDPE							WEIGHT	PACKING SIZE
SILVER	BLACK	FOR	H	W	D	WITH PACKING	*W X H X D	
UTWM003000	UTWM003010	22" X 28"	40.47"	28.35"	20.87"	9.876 lbs	21.85" X 29.53" X 7.01"	
UTWM003000	UTWM003010	24" X 36"	48.46"	28.35"	20.87"	9.876 lbs	21.85" X 29.53" X 7.01"	
UTWM004000	UTWM004010	30" X 40"	52.48"	35.43"	24.80"	15.101 lbs	23.82" X 36.61" X 7.01"	

*W:Width H: Height D: Depth



Mix and Match



See movie at our website www.mtdisplays.com.tr

Newtech Waterbase

Small

- Printing area: 11.81"x3.15"
- Base Weight: 77.161 lbs.
- Water Capacity: 811.536 oz.
- Weight when full with water: 60.627 lbs.

Large

- Printing area: 7.72"x3.54"
- Base Weight: 11.023 lbs.
- Water Capacity: 1352.560 oz.
- Weight when full with water: 99.208 lbs.

Roto Waterbase

Small Base

- Used in 20"x30", 22"x28" sizes.
- Weight when empty is 11.023 lbs.
- Weight when filled with water is 77.161 lbs.
- Small base can take in 1014.420 oz of water.

Large Base

- Used in 30"x40" sizes.
- Weight when empty is 14.330 lbs.
- Weight when filled with water is 94.798 lbs.
- Large base can take in 1234.211 oz of water.

Medium Leg

- Used in 20"x30", 22"x28" sizes.

Large Leg

- Used in 30"x40" size.

The weights are approximate values per each base.

Newtech Waterbase / Lite Frame



Roto Waterbase / Standard Frame



Newtech Waterbase / Plus Frame



Newtech Waterbase / Slide-in Frame



Steel Base

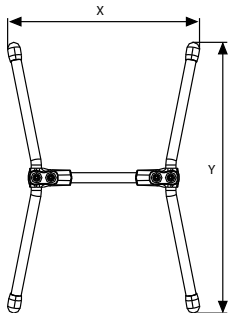

STEEL BASE		
ARTICLE	SIZE (x-y)	DESCRIPTION
UTSM003000	35.04" X 49.61"	Large-Grey
UTSM003010	35.04" X 49.61"	Large-Black
UTSM002000	27.17" X 42.13"	Medium-Grey
UTSM002010	27.17" X 42.13"	Medium-Black

Roto Waterbase

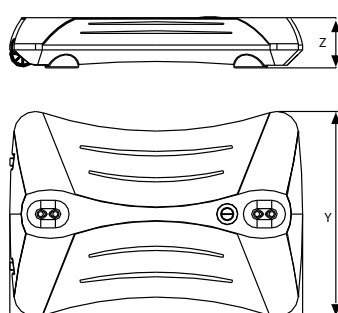

ROTO WATERBASE		
ARTICLE	SIZE (x-y-z)	DESCRIPTION
UTWM002000	34.43" X 24.80" X 6.10"	Large-Grey
UTWM002010	34.43" X 24.80" X 6.10"	Large-Black
UTWM001000	28.35" X 22.83" X 6.10"	Small-Grey
UTWM001010	28.35" X 22.83" X 6.10"	Small-Black

Newtech Waterbase

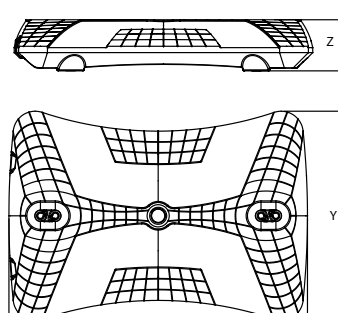

NEWTECH WATERBASE		
ARTICLE	SIZE (x-y-z)	DESCRIPTION
UTWM004000	34.43" X 24.80" X 6.10"	Large-Grey
UTWM004010	34.43" X 24.80" X 6.10"	Large-Black
UTWM003000	28.35" X 20.87" X 6.10"	Small-Grey
UTWM003010	28.35" X 20.87" X 6.10"	Small-Black

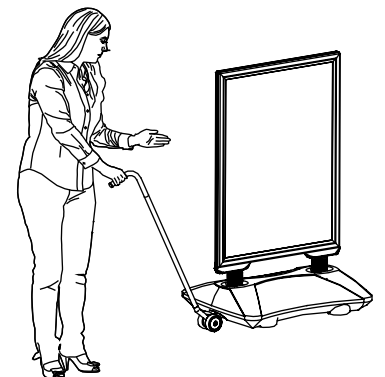

UYUP480945
Optional carry tool for WindPro.
Pulling force 13.227 - 17.636 lbs max.

The weights are approximate values per each base.

- Weekly 3,000 pcs production capacity.
- Assembly in 65 seconds.
- Suitable for use -20°C degrees.



See movie at our website www.mtdisplays.com.tr

Illuminated WindPro[®] with LED



See movie at our website www.mtdisplays.com.tr



MT Displays' innovative and user friendly Illuminated WindPro with LED is an eye-catcher product will attract consumers to message and place. Energy saving and bright modes are applied with switch easily. Life PO4 battery which provides high power on low weight is hidden on the base to give a neat look at Illuminated WindPro. Lockable UV polycarbonate covers and locked battery compartment keep the poster and battery in safe. The upper frame is weatherproof non-snap body, has elastic rope that hinges the cover and can be secured via 12 locks. The installation of visual is very simple by inserting the visual upwards into metal poster clips.

Charging unit included. Battery can't be charged in the product. Chrome coated zamak mitred look and yet soft finish corners.

Battery will be shipped at full charge capacity see digital LED indication on battery to recharge.



A unique solution as a Pavement Sign with battery

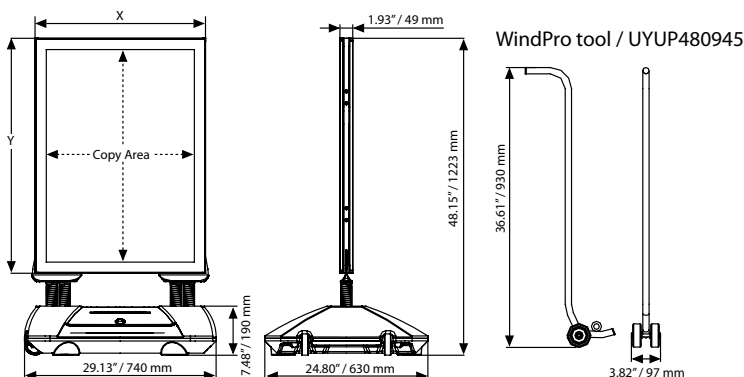

MATERIAL : Silver & black powder coated frame & waterbase				WEIGHT	PACKING SIZE
ARTICLE	EXTERNAL (x-y)	POSTER	COPY	WITH PACKING	*W X H X D
USWL000A1	25.91" X 35.71"	23.39" X 33.11"	22.52" X 32.32"	77.382 lbs	33.07" X 55.91" X 4.41" 26.77" X 30.71" X 7.80"



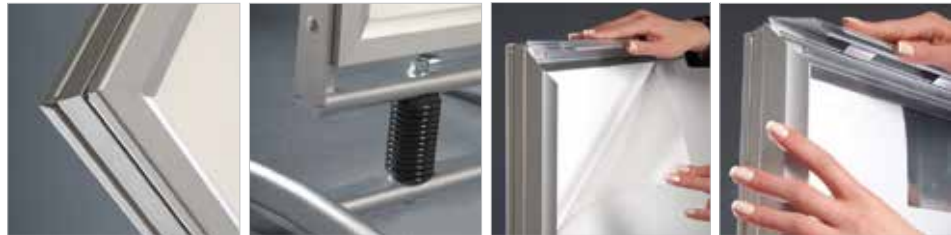

*W:Width H: Height D: Depth

Swingmaster



Various sizes are available all with mitred corners. Poster use is double sided. A rubber seal is incorporated which, in addition to the over size anti-glare PET cover, helps to make the product waterproof. The double sided product with its easy to open frame has steel springs for flexibility and stability.

-  The product is packed unassembled with an easy mounting instruction sheet & fixing set.
-  Suitable for windy outdoor conditions. Suitable for rainy conditions, the rubber seal around the frame protect the poster within. Round corners raise the safety level on the pavement.
-  Heavy long feet on the base provide stability.

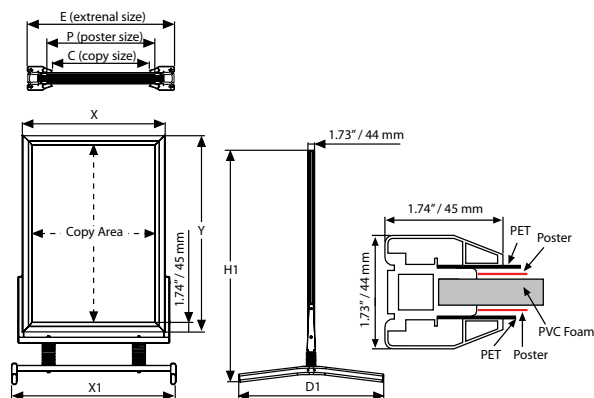

MATERIAL : Silver anodised aluminium					WEIGHT	PACKING SIZE	LEG		
ARTICLE	EXTERNAL (x-y)	POSTER	COPY	H1	WITH PACKING	*W X H X D	X1	D1	SPRINGS
UASM000N23	22.83" X 32.83"	20" X 30"	19.29" X 29.29"	42.20"	30.864 lbs	41.34" X 28.74" X 4.53"	25.28"	35.43"	2
UASM000N34	32.83" X 42.83"	30" X 40"	29.29" X 39.29"	52.20"	45.415 lbs	53.15" X 38.19" X 4.53"	35.28"	48.82"	2
UASM000N46	42.83" X 62.83"	40" X 60"	39.29" X 59.29"	72.20"	65.036 lbs	70.87" X 47.24" X 4.53"	45.28"	62.99"	2



* W:Width H: Height D: Depth

Eco Swingmaster



See movie at our website www.mtdisplays.com.tr



Various sizes are available all with safe mitred corners. Its round corners do not have sharp edges. After the closure of the side profiles, the rubber seal inside the swingmaster in addition with over size PET makes the product waterproof. The easy-to-open snap frame includes an anti-reflex cover suitable for external use when equipped with a water wick. Product is double sided. The steel springs provide the flexibility to ensure stability.

- The product is packed unassembled with an easy mounting instruction sheet & fixing set.
- Suitable for windy outdoor conditions. Suitable for rainy conditions, the rubber seal around the frame protect the poster within. Round corners raise the safety level on the pavement.
- Heavy long feet on the base provide stability.
- 2 packs. See info chart for pack sizes.

IMPROVED FOR 2018

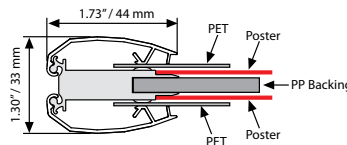
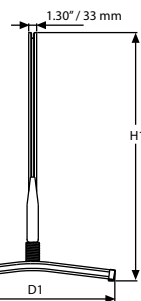
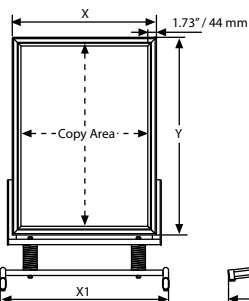
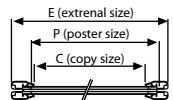

MATERIAL : Silver anodised aluminium					WEIGHT	PACKING SIZE	LEG		
ARTICLE	EXTERNAL (x-y)	POSTER	COPY	H1	WITH PACKING	*W X H X D	X1	D1	SPRINGS
UESM000N22	25.03" X 31.03"	22" X 28"	21.53" X 27.53"	40.94"	27.116 lbs	29.72" X 36.81" X 4.13"	25.28"	35.43"	2
UESM000N23	23.03" X 33.03"	20" X 30"	19.53" X 29.53"	42.32"	27.116 lbs	27.95" X 38.98" X 4.13"	25.28"	35.43"	2
UESM000N24	27.03" X 39.03"	24" X 36"	23.53" X 35.53"	49.02"	34.171 lbs	27.95" X 41.34" X 4.13"	28.66"	41.34"	2
UESM000N34	33.03" X 43.03"	30" X 40"	29.53" X 39.53"	53.35"	41.887 lbs	965" X 50.79" X 4.13"	35.28"	48.82"	2
UESM000N46	43.03" X 63.03"	40" X 60"	39.53" X 59.53"	74.61"	57.320 lbs	48.03" X 71.06" X 4.13"	45.28"	62.99"	2

*W:Width H: Height D: Depth



Waterbase Wind Sign



See movie at our website www.mtdisplays.com.tr



Various sizes are available all with mitred corners. After the closure of the side profiles, the rubber seal inside the wind sign in addition with over size PET makes the product waterproof. The easy-to-open snap frame includes an anti-reflex cover suitable for external use when equipped with a water wick. Product is double sided. The steel springs provide the flexibility to ensure stability. The wheels enable the movement of the units.

The product is packed unassembled. Water base of A2, A1, 500x700 mm 20 kg. Water base of A0, 700x1000 mm 33 kg. Each base is supplied with industrial salt to prevent freezing in winter conditions. Each product comes unassembled with easy-to-understand instruction sheet & fixing set.

Base standard in metallic grey color. Other colors are available upon request. Suitable for windy & rainy conditions, protects the poster within. Ground wheels in upside position facilitate movement of the product.



UYUP480945
Optional carry tool.
Pulling force
6-8 kg max.

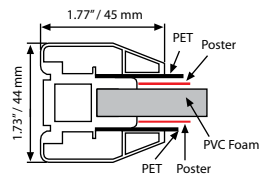
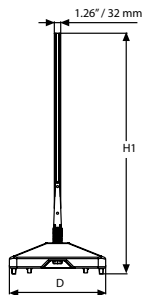
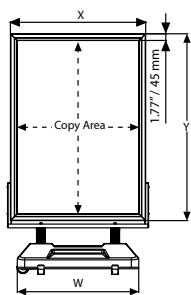
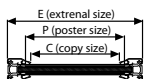
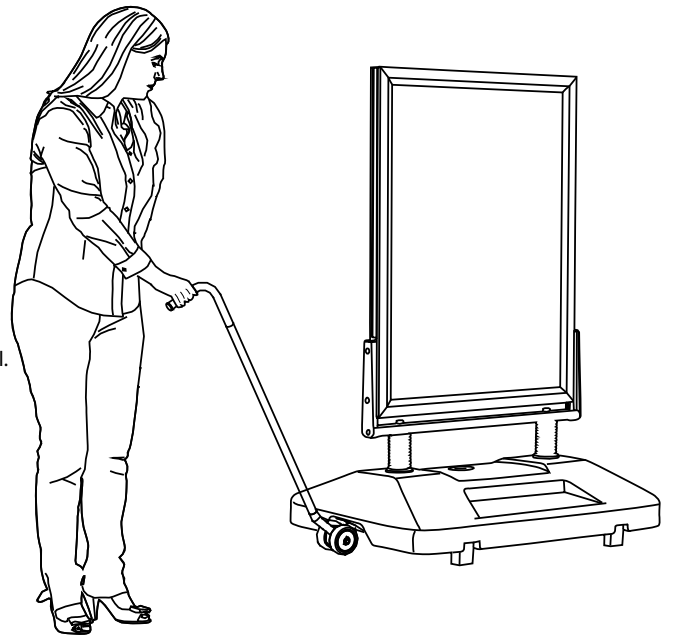

MATERIAL : Silver anodised aluminium					WEIGHT	PACKING SIZE
ARTICLE	EXTERNAL (x-y)	POSTER	COPY	H1	WITH PACKING	*W X H X D
UWWM000N23	22.83" X 32.83"	20" X 30"	19.29" X 29.29"	44.88"	23.479 lbs	43.31" X 24.80" X 2.95"
UWWM000N34	32.83" X 42.83"	30" X 40"	29.29" X 39.29"	56.30"	34.833 lbs	55.91" X 35.43" X 2.95"
UWWM000N46	42.83" X 62.83"	40" X 60"	39.29" X 59.29"	77.17"	44.092 lbs	44.88" X 76.38" X 2.95"

*W:Width H: Height D: Depth

Eco Waterbase Wind Sign



See movie at our website www.mtdisplays.com.tr



Various sizes are available all with safe mitred corners. Its round corners do not have sharp edges. After the closure of the side profiles, the rubber seal in addition with over size PET makes the product waterproof. The easy-to-open snap frame includes an anti-reflex cover. The steel springs provide the flexibility to ensure stability. The wheels ensure the movement of the unit. Product is double sided.

Each base comes with industrial salt to prevent freezing in winter conditions. Each product comes unassembled with an easy-to-understand instruction sheet & fixing set.

Suitable for rainy & windy conditions, protects the poster within. Ground wheels in upside position facilitate movement of the product. Round corners raise the safety level on the pavement. The standard color of is metallic grey while other colors are available upon request.

Heavy base provides stability.

IMPROVED FOR 2018

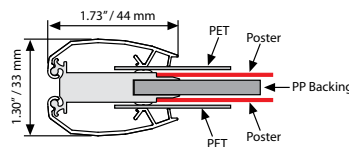
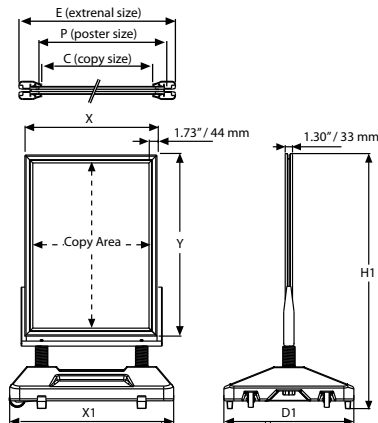
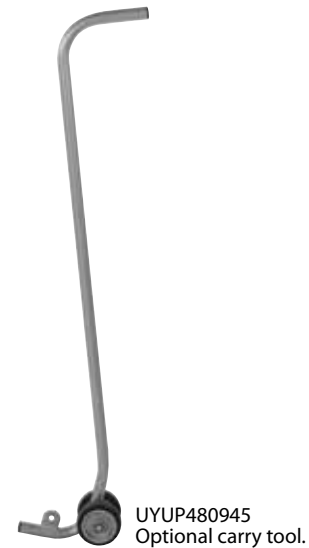

MATERIAL : Silver anodised aluminium						
ARTICLE	EXTERNAL (x-y)	POSTER	COPY	H1	X1	D1
UEWM000N22	25.03" X 31.03"	22" X 28"	21.53" X 27.53"	45.08"	27.56"	21.35"
UEWM000N23	23.03" X 33.03"	20" X 30"	19.53" X 29.53"	46.85"	27.56"	21.65"
UEWM000N24	27.03" X 39.03"	24" X 36"	23.53" X 35.53"	53.35"	32.28"	25.59"
UEWM000N34	33.03" X 43.03"	30" X 40"	29.53" X 39.53"	57.28"	32.28"	25.59"
UEWM000N46	43.03" X 63.03"	40" X 60"	39.53" X 59.53"	74.02"	39.37"	29.53"

MAIN BODY		WATER BASE	
WEIGHT	PACKING SIZE	WEIGHT	PACKING SIZE
WITH PACKING	*W X H X D	WITH PACKING	*W X H X D
17.526 lbs	26.18" X 40.55" X 1.57"	17.857 lbs	22.44" X 28.35" X 9.45"
17.526 lbs	24.21" X 43.31" X 1.57"	17.857 lbs	22.44" X 28.35" X 9.45"
19.731 lbs	27.95" X 48.82" X 1.57"	25.353 lbs	33.07" X 26.38" X 9.45"
24.912 lbs	34.45" X 53.15" X 1.57"	25.353 lbs	33.07" X 26.38" X 9.45"
37.478 lbs	39.96" X 67.52" X 1.57"	30.864 lbs	40.16" X 30.31" X 9.45"

*W:Width H: Height D: Depth



Waterbase Wind Sign Base

Small Base

- Used in 20"x30" sizes
- Weight when empty is 17.636 lbs.
- Weight when filled with water is 79.366 lbs
- Small base can take in 28 liters of water.

Medium Base

- Used in 30"x40" size.
- Weight when empty is 19.841 lbs.
- Weight when filled with water is 101.412 lbs.
- Medium base can take in 37 liters of water.

Large Base

- Used in 40"x60" size.
- Weight when empty is 33.069 lbs
- Weight when filled with water is 152.118 lbs.
- Large base can take in 54 liters of water.

The weights are approximate values per each base.

Small Base

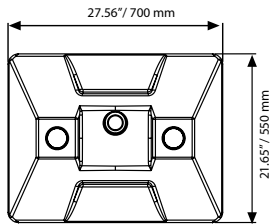
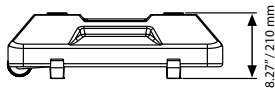

Medium Base

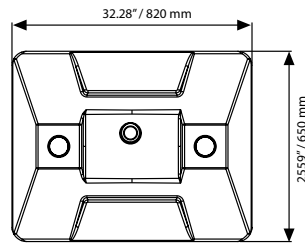
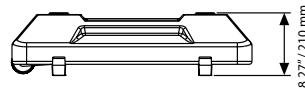

Large Base

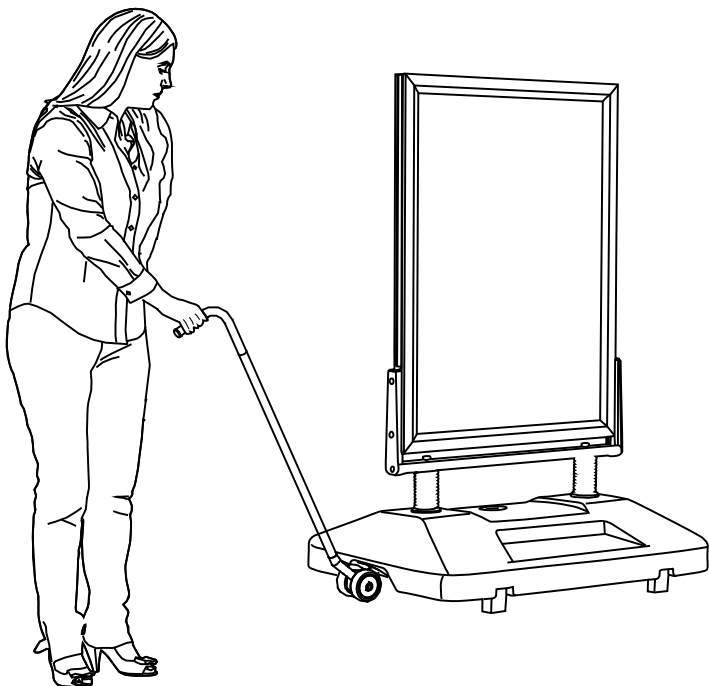
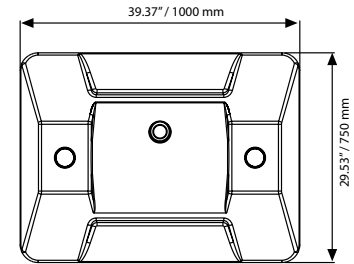

WIND SIGN BASE			WEIGHT	PACKING SIZE
ARTICLE	DESCRIPTION	SPRINGS	WITH PACKING	*W X H X D
UYUP406820	Small base	2	17.857 lbs	22.44" X 28.35" X 9.45"
UYUP406810	Medium Base	2	25.353 lbs	33.07" X 26.38" X 9.45"
UYUP406840	Large Base	2	30.864 lbs	40.16" X 30.31" X 9.45"

*W:Width H: Height D: Depth

Pavement Sign Headers



SwingPro® Lite Header
WindPro® Lite Header

SwingPro® Plus Header
WindPro® Plus Header

Eco Swingmaster Header
Eco Waterbase Wind Sign Header

A Board Header
Eco Aboard Header
A Board with Safe Corner Header



SwingPro® Lite



SwingPro® Plus



Eco Swingmaster



A Board



WindPro® Lite



WindPro® Plus



Eco Waterbase Wind Sign

Header / Topschild

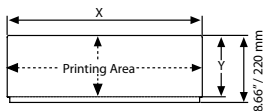

HEADER: 0.12" PVC Foam				WEIGHT
ARTICLE	SIZE	PRINTING AREA (x-y)	WITH PACKING	
UYFT004022	22" X 28"	23.50" X 7.87"	0.551 lbs	
UYFT004024	24" X 36"	25.51" X 7.87"	0.595 lbs	
UYFT004034	30" X 40"	31.50" X 7.87"	0.738 lbs	
UYFT004084	28" X 44"	29.53" X 7.87"	0.683 lbs	

Header / Topschild

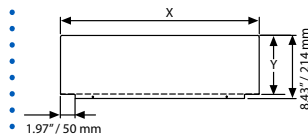

HEADER: 0.12" PVC Foam				WEIGHT
ARTICLE	SIZE	PRINTING AREA (x-y)	WITH PACKING	
UYFT005022	22" X 28"	25" X 7.87"	0.551 lbs	
UYFT005023	20" X 30"	23.03" X 7.87"	0.507 lbs	
UYFT005024	24" X 36"	27.05" X 7.87"	0.595 lbs	
UYFT005034	30" X 40"	33.03" X 7.87"	0.738 lbs	
UYFT0050F0	F0	34.53" X 7.87"	0.771 lbs	

Header / Topschild

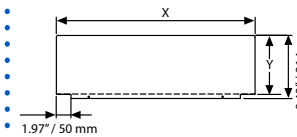

HEADER: 0.12" PVC Foam				WEIGHT
ARTICLE	SIZE	PRINTING AREA (x-y)	WITH PACKING	
UYFT005022	22" X 28"	25" X 7.87"	0.551 lbs	
UYFT005023	20" X 30"	23.03" X 7.87"	0.507 lbs	
UYFT005024	24" X 36"	27.05" X 7.87"	0.595 lbs	
UYFT005034	30" X 40"	33.03" X 7.87"	0.738 lbs	
UYFT005046	40" X 60"	43.03" X 7.87"	0.992 lbs	

Header / Topschild

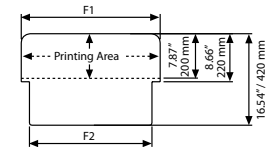

HEADER FOR 0.16" PVC Foam			WEIGHT
ARTICLE	F1	F2	WITH PACKING
UYFT000022	23.54"	20.47"	1.543 lbs
UYFT000023	21.57"	18.50"	1.763 lbs
UYFT000024	25.59"	22.52"	2.645 lbs
UYFT000034	31.57"	28.50"	3.196 lbs

HEADER FOR 1" PVC Foam			WEIGHT
ARTICLE	F1	F2	WITH PACKING
UYFT250022	23.15"	16.54"	0.881 lbs
UYFT250024	25.16"	16.54"	1.234 lbs

Header Holder / Topschild Halter

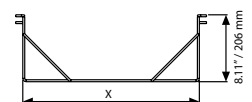

HEADER HOLDER		WEIGHT
ARTICLE	X	WITH PACKING
UYTT000022	17.44"	1.609 lbs
UYTT000023	19.41"	1.653 lbs
UYTT000024	23.43"	1.741 lbs
UYTT000034	29.41"	1.918 lbs

HEADER HOLDER		WEIGHT
ARTICLE	X	WITH PACKING
UYTT250022	20.12"	1.719 lbs
UYTT250024	22.36"	1.807 lbs

*W:Width H: Height D: Depth

Al Maki



See movie at our website www.mtdisplays.com.tr







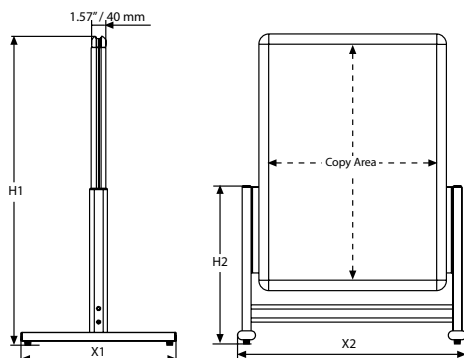

A double-sided customer stopper, practical to change the poster within. 22"X28" size available. 1.26" profile, snap frame. Round or mitred corner options.

 Single packed with an easy-to-understand instruction sheet

 Heavy back panel provides stability. No tool assembly.



MATERIAL : Silver anodised aluminium						WEIGHT	PACKING SIZE
ARTICLE	POSTER	X1	X2	H1	H2	WITH PACKING	*W X H X D
UAM321CN22	22" X 28"	24.41"	28.35"	34.65"	18.11"	13.668 lbs	25.98" X 33.46" X 2.76"

       *W:Width H: Height D: Depth



Rectangular Iron A Board



See movie at our website www.mtdisplays.com.tr



Stable & heavy pavement sign, used from both sides. There is a magnetic cover placed over the poster. Suitable for highly frequented public areas.

-  Product is packed single & assembled.
-  No tool assembly. Finger hole allows for an easy change of the poster.
-  Heavy steel feet provide stability. Backing tray is galvanized as a standard product, powder coating is optional. Comes in black, silver, white color options.

Color options:

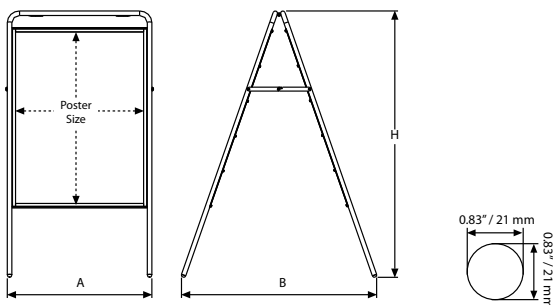

Header / Topchild

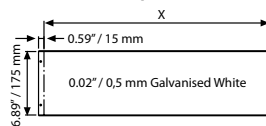

MATERIAL : Iron A Board							WEIGHT	PACKING SIZE
ARTICLE	POSTER	A	B	H	X	DESCRIPTION	WITH PACKING	*W X H X D
UABD211N23	20" X 30"	22.83"	35.43"	48.43"	21.18"	With header	29.530 lbs	24.41" X 53.15" X 3.15"
UABD210N23	20" X 30"	22.83"	35.43"	48.43"	-	Without header	27.888 lbs	24.41" X 53.15" X 3.15"

* W:Width H: Height D: Depth



Magnetic Iron A Board



Stable & heavy pavement sign, used from both sides. There is a magnetic cover placed over the poster. The poster sizes are 22"x28", 20"x30", 24"x36". Other sizes are available upon request. Suitable for highly frequented public areas.

Product is packed single & assembled.

No tool assembly. Finger hole allows for an easy change of the poster. Header is standard supplied and provides space for corporate logo.

Heavy steel feet provide stability. Backing tray is galvanized in standard product, powder coating is optional. Comes in black, silver, white color options.

Color options:



Header / Topschild

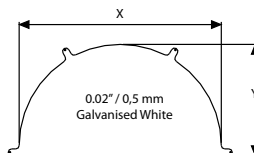
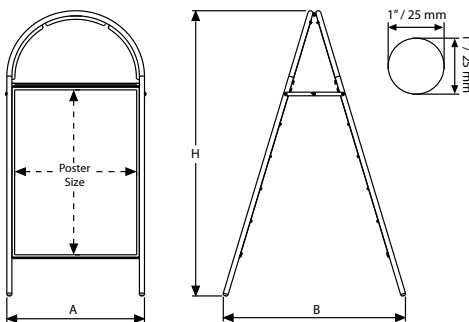

HEADER				
ARTICLE	POSTER	X	Y	
UABD255N22	22" X 28"	22"	12.32"	
UABD255N23	20" X 30"	20"	11.18"	
UABD255N24	24" X 36"	24"	17.44"	
UABD255B22	22" X 28"	22"	12.32"	
UABD255B23	20" X 30"	20"	11.18"	
UABD255B24	24" X 36"	24"	17.44"	

MATERIAL : Iron A Board					WEIGHT	PACKING SIZE
ARTICLE	POSTER	A	B	H	WITH PACKING	*W X H X D
UABD255N22	22" X 28"	25.20"	27.56"	45.28"	34.281 lbs	26.38" X 51.97" X 2.95"
UABD255N23	20" X 30"	23.15"	33.46"	48.03"	33.730 lbs	24.02" X 51.97" X 2.95"
UABD255N24	24" X 36"	33.15"	39.37"	64.17"	40.785 lbs	31.89" X 70.87" X 2.95"
UABD255B22	22" X 28"	25.20"	27.56"	45.28"	34.281 lbs	26.38" X 51.97" X 2.95"
UABD255B23	20" X 30"	23.15"	33.46"	48.03"	33.730 lbs	24.02" X 51.97" X 2.95"
UABD255B24	24" X 36"	33.15"	39.37"	64.17"	40.785 lbs	31.89" X 70.87" X 2.95"

* W:Width H: Height D: Depth





Waterbase Pavement Signs



Stable, heavy and enduring pavement sign. Suitable to set aside in parking areas, play grounds, shop entrances and busy pavement roads; especially for windy areas. Standard in metallic RAL 9006 color. By opening the plastic stoppers, you can pour in either water or sand to make the stand heavier.

 The product is packed unassembled. Each base is supplied with industrial salt to prevent freezing in winter conditions. Printing area has a +/- 0.06" tolerance in size.

 No tool assembly.

 Heavy base provides stability. Suitable for outdoor conditions. Stickers are not included in the original box.



Maximum water capacity is 152.163 ounces



Maximum water capacity is 169.070 ounces

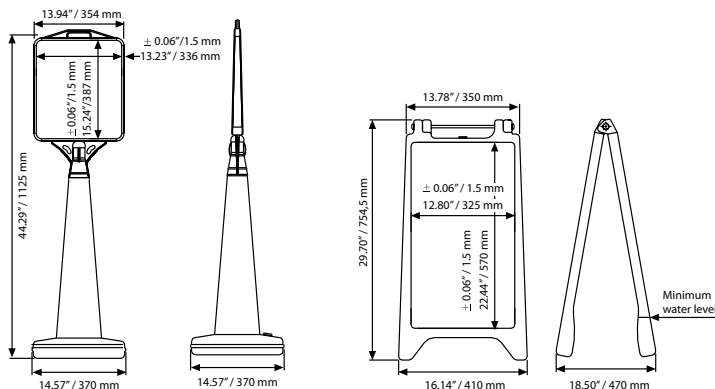

MATERIAL : Polystyrene			WEIGHT	PACKING SIZE
ARTICLE	MODEL	WEIGHT with water	WITH PACKING	*W X H X D
UWPS005000	Pyramid	12.125 lbs	7.859lbs	15.75" X 27.56" X 15.75"
UWPS001000	A Board	17.636 lbs	7.848 lbs	16.54" X 28.35" X 4.92"

*W:Width H: Height D: Depth





PS Boards



See movie at our website www.mtdisplays.com.tr

Simple plastic pavement board for multiple purposes. PS Display is suitable for inkjet printing and adhesive folio. Easy to move and store. Suitable to write on with water base chalk pens.



-  Product is single packed.
-  No tool assembly.
-  Suitable for chalk pens. We sell pens individually in handy sets.



Provide easy lift of the sign

PS Chalk Board

Carry PS Board

PS Board



Chalkboard Marker
UYKLM1251 - Colour Marker
UYKLM1250 - White Marker

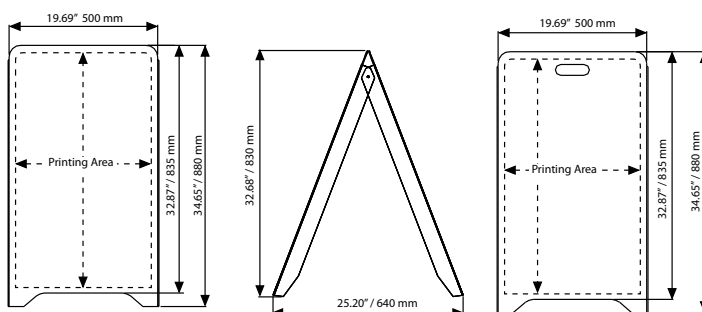

MATERIAL : Polystrene				WEIGHT	PACKING SIZE
ARTICLE	SIZE	PIRINTING AREA	MODEL	WITH PACKING	*W X H X D
UPYP000000	19.69" X 34.65"	18.90" X 32.09"	PS Board	9.479 lbs	20.87" X 35.83" X 3.15"
UPYPE00000	19.69" X 34.65"	18.90" X 32.09"	Carry PS Board	9.479 lbs	20.87" X 35.83" X 3.15"
UPYP001000	19.69" X 34.65"	18.90" X 32.09"	PS Chalk Board	9.479 lbs	20.87" X 35.83" X 3.15"

*W:Width H: Height D: Depth





Wood Displays

- Easy Wood Frame
- Frameless Wooden Frame
- Wooden Stopper
- Wooden Host
- Wood A Board Outdoor
- Wood A Board Indoor
- Timber Chalk Board **NEW**
- Wall Mount Wooden Card Holder **NEW**
- Desktop Wooden Card Holder **NEW**
- Wood Magazine Rack for Wall **NEW**
- Free Standing Wood Magazine Rack **NEW**
- Wood Podium **NEW**
- Foldable Wood Box **NEW**



Chalkboard Markers are ideal for handwriting on boards.

They are waterproof and fade resistant outdoor. Yet remarkably their surfaces can be easily cleared of materials such as glass and plastics. This helps you to change your messages or prices. Our standard pen sets are defined next with the colors inside.



Easy to wipe off

Windows, board and all non-porous surfaces.



0.39" suitable for thick writing.

BIG CHALKBOARD MARKER SET (5 Pcs)					
ARTICLE	COLOUR				
UYAKLM1251	Red	Yellow	Pink	Green	Orange



0.39" suitable for thick writing.

WHITE CHALKBOARD MARKER SET (3 Pcs)	
ARTICLE	COLOUR
UYAKLM1250	White



Wooden Frames

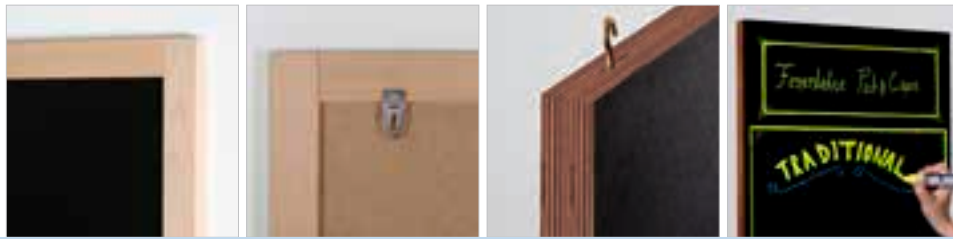

Suitable for the display of messages in restaurants, cafés, bars, malls, offices and education centers. The erasable surface enables you to erase your messages and transmit them to your audience while keeping them updated. You can use a chalkboard pen to write on the black surface. There are also special water-based and scent-free markers. We sell chalk pens individually 2 in convenient sets.

Each unit comes ready with mounting set, and easy to assemble instruction sheet.

Chalkboard pens are not included in the original pack, should be ordered separate. For spotless removing of chalk pens from surface, please use window & glass cleaner otherwise clean with damp cloth.



Don't forget to order Chalkboard Marker
UYAKLM1251 - Colour Marker
UYAKLM1250 - White Marker

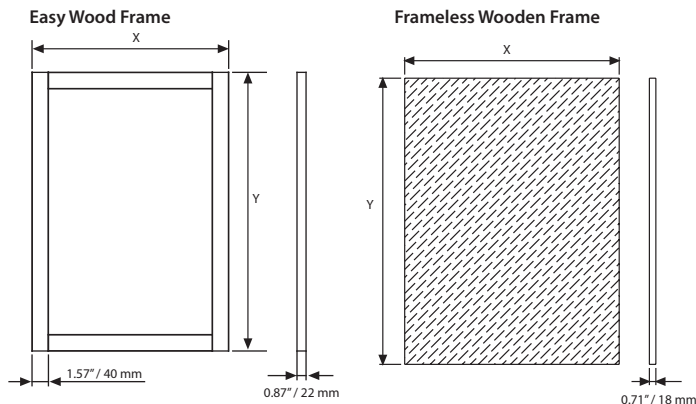

FRAMELESS FRAME : Fir wood			WEIGHT	PACKING SIZE
ARTICLE	SIZE	DESCRIPTION	WITH PACKING	*W X H X D
UWFF010018	18" X 24"	Black Chalkboard	2.866 lbs	18.90" X 25.20" X 0.94"
UWFF010022	22" X 28"	Black Chalkboard	4.398 lbs	22.83" X 29.33" X 0.94"
UWFF010023	24" X 36"	Black Chalkboard	5.059 lbs	24.80" X 37.20" X 0.94"
UWFF010036	36" X 48"	Black Chalkboard	10.361 lbs	36.81" X 49.21" X 0.94"

EASY WOOD FRAME : Beech wood				WEIGHT	PACKING SIZE
ARTICLE	EXTERNAL (x-y)	SIZE	DESCRIPTION	WITH PACKING	*W X H X D
UWSS010034	14.96" X 18.90"	11.81" X 15.75"	Black Chalkboard		
UWSS010046	18.90" X 26.77"	15.75" X 23.62"	Black Chalkboard		
UWSS010049	18.90" X 38.58"	15.75" X 35.43"	Black Chalkboard		
UWSS010068	26.77" X 34.65"	23.62" X 31.50"	Black Chalkboard		
UWSS010061	26.77" X 48.43"	23.62" X 45.28"	Black Chalkboard		
UWSS010081	34.65" X 50.39"	31.50" X 47.24"	Black Chalkboard		



*W:Width H: Height D: Depth

Wooden Stopper



It is made of solid wood. The erasable surface enables you to erase your messages and transmit them to your audience while keeping them updated. You could use a chalkboard pen to write on black surfaces. There are also special markers that are water based and scent-free. Suitable for the display of your messages indoors and outdoors in places such as restaurants, cafés, bars, malls, offices and education centers.



Each unit comes ready to use no tool assembly.



Chalkboard pens are not included in the original pack, should be ordered separately.

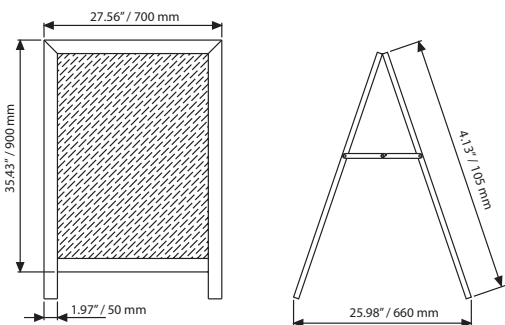

Don't forget to order
Chalkboard Marker
UYAKLM1251 - Colour Marker
UYAKLM1250 - White Marker

MATERIAL : Fir wood			WEIGHT	PACKING SIZE
ARTICLE	SIZE	DESCRIPTION	WITH PACKING	*W X H X D
UWSR110068	23.62" X 31.50"	Black chalkboard, massive wood	14.285 lbs	28.35" X 43.31" X 2.44"





* W:Width H: Height D: Depth

Wooden Host



Special top hinge design holds it stable. The erasable surface enables you to erase your messages and transmit them to your audience while keeping them updated. You could use a chalkboard pen to write on black surfaces. There are also special markers that are water based and scent-free. Suitable for the display of your messages indoor and outdoor in places such as restaurants, cafés, bars, malls, offices and education centers. Special wood construction is suitable for many years of use indoor & outdoor.

 Each unit comes ready to use no tool assembly.

 Chalkboard pens are not included in the original pack, should be ordered separately.

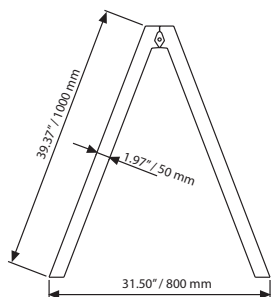
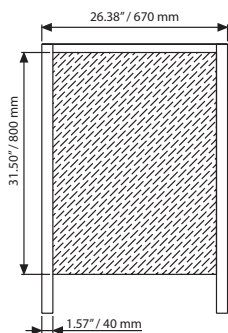

Don't forget to order
Chalkboard Marker
UYAKLM1251 - Colour Marker
UYAKLM1250 - White Marker

MATERIAL : Fir wood			WEIGHT	PACKING SIZE
ARTICLE	SIZE	DESCRIPTION	WITH PACKING	*W X H X D
UWHT010068	23.62" X 31.50"	Black chalkboard, solid wood	19.621 lbs	27.56" X 40.94" X 5.71"

*W:Width H:Height D:Depth



Wood A Board Outdoor

new



It is made of solid wood. Aluminum composite backing provides availability for open air usage for Outdoor A Board.

The erasable surface enables for erasing the messages and transmit them to your audience while keeping as updated easily. Chalkboard pen can be used for black surfaces to display the messages. Also water-based and scent free markers are proper for writing on it. Suitable for outdoor places such as restaurants, cafes, bars, malls, offices and education centers.

Each unit comes ready to use without any tool for assembly.

Chalkboard pen should be ordered separately. Henge and chain is different on 18.11"x26.77" than other sizes which aims to increase performance of small size.

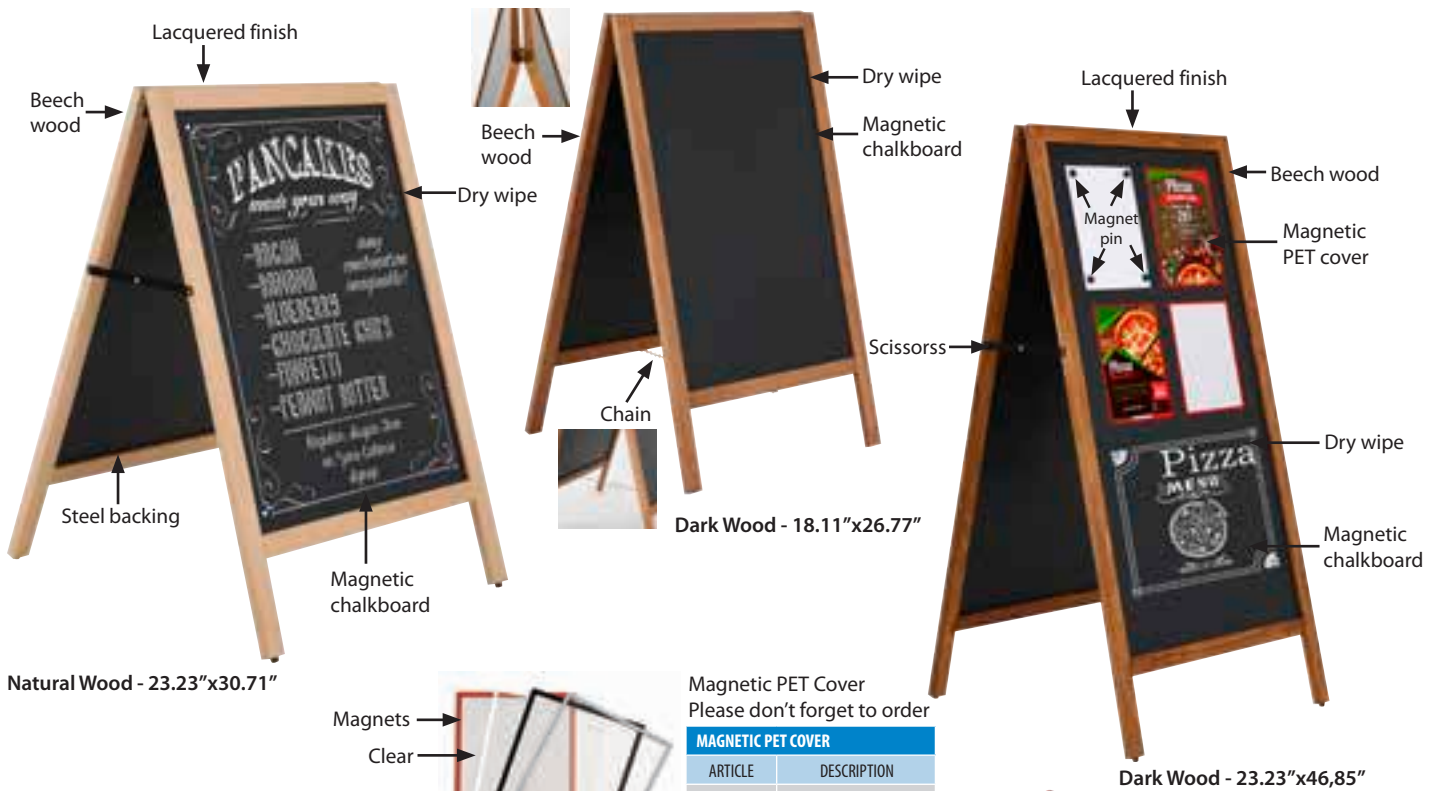

Magnetic PET Cover
Please don't forget to order

MAGNETIC PET COVER	
ARTICLE	DESCRIPTION
UPCM0R00A4	Magnetic 8.5" X 11" Red
UPCM0B00A4	Magnetic 8.5" X 11" Black
UPCM0W00A4	Magnetic 8.5" X 11" White
UPCM0G00A4	Magnetic 8.5" X 11" Gray



Don't forget to order
Chalkboard Marker
UYAKLM1251 - Colour Marker
UYAKLM1250 - White Marker

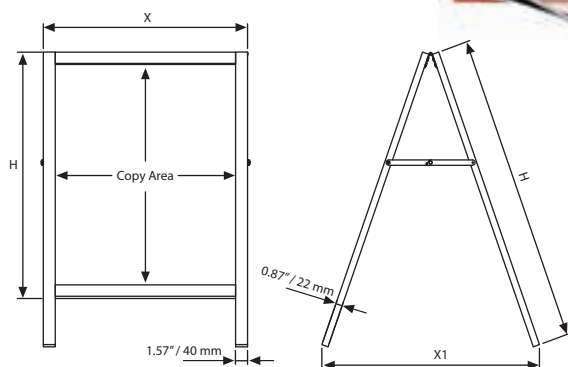

MATERIAL : Beech wood						WEIGHT	PACKING SIZE
ARTICLE	EXTERNAL (x-y)	SIZE	DESCRIPTION	H	X1	WITH PACKING	*W X H X D
UWOD004668	21.26" X 29.92"	18.11" X 26.77"	Natural Wood	37.40"	20.08"	17.196 lbs	22.05" X 37.40" X 2.36"
UWOD004668	21.26" X 29.92"	18.11" X 26.77"	Dark Wood	37.40"	20.08"	17.196 lbs	22.05" X 37.40" X 2.36"
UWOD006078	26.38" X 33.86"	23.23" X 30.71"	Natural Wood	41.34"	22.05"	18.673 lbs	28.15" X 41.34" X 2.17"
UWOD006078	26.38" X 33.86"	23.23" X 30.71"	Dark Wood	41.34"	22.05"	18.673 lbs	28.15" X 41.34" X 2.17"
UWOD006012	26.38" X 50"	23.23" X 46.85"	Natural Wood	57.09"	29.53"	33.422 lbs	28.15" X 58.66" X 2.36"
UWOD006012	26.38" X 50"	23.23" X 46.85"	Dark Wood	57.09"	29.53"	33.422 lbs	28.15" X 58.66" X 2.36"

*W:Width H:Height D:Depth



Wood A Board Indoor



It is made of solid wood. MDF backing provides availability for closed area usage for Indoor A Board. The erasable surface enables for erasing the messages and transmit them to your audience while keeping as updated. Chalkboard pen can be used for black surfaces to display the messages. Also water-based and scent free markers are proper for writing on it. Suitable for indoor places such as restaurants, cafes, bars, malls, offices and education centers.

 Each unit comes ready to use without any tool for assembly

 Chalkboard pen should be ordered separately.

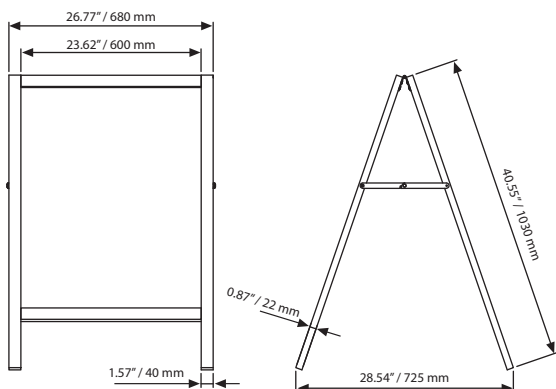

Don't forget to order
Chalkboard Marker
UYAKLM1251 - Colour Marker
UYAKLM1250 - White Marker

MATERIAL : Beech wood			WEIGHT	PACKING SIZE
ARTICLE	SIZE	DESCRIPTION	WITH PACKING	*W X H X D
UWID006078	23.62" X 30.71"	Black chalkboard, solid wood	16.865 lbs	28.15" X 41.34" X 2.17"

*W:Width H:Height D:Depth



Timber Chalk Board

new



Timber Chalk Board is made of solid Beech wood. Slide in panels are galvanised steel sheets which ensures for outdoor use as heavy and rust-free. The erasable surface enables for erasing the messages and transmit them to your audience while keeping as updated easily. Slide in panels are double sided to make sure timely use of A Frame. So two different messages of advertisement can be stored on the panels. Chalk or chalkboard water-based pen can be used for black surfaces to display the messages. Suitable for outdoor places such as restaurants, cafes, bars, malls, offices and many more.



Each unit comes ready to use



Chalkboard pen and magnetic covers should be ordered separately.



Natural Wood



Dark Wood

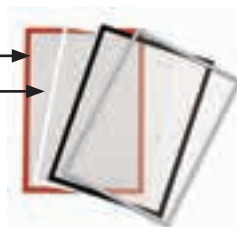
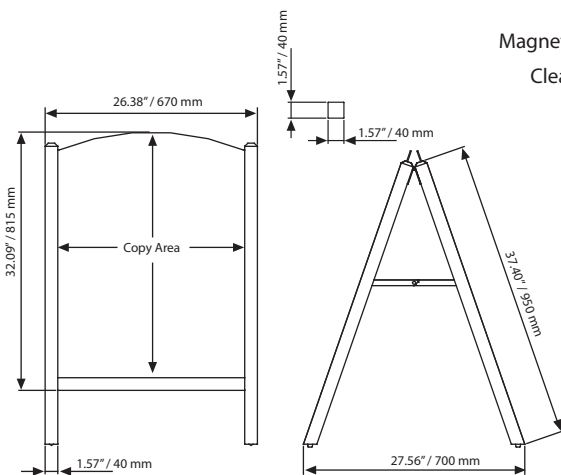

Magnetic PET Cover
Please don't forget to order

MAGNETIC PET COVER	
ARTICLE	DESCRIPTION
UPCMOR00A4	Magnetic 8.5" X 11" Red
UPCMOB00A4	Magnetic 8.5" X 11" Black
UPCMOW00A4	Magnetic 8.5" X 11" White
UPCMOG00A4	Magnetic 8.5" X 11" Gray



Don't forget to order
Chalkboard Marker
UYAKLM1251 - Colour Marker
UYAKLM1250 - White Marker

MATERIAL : Beech wood				WEIGHT	PACKING SIZE
ARTICLE	SIZE	COPY	DESCRIPTION	WITH PACKING	*W X H X D
UWTC006078	26.77" X 30.71"	23.23" X 30.51"	Natural Wood-Outdoor	30.467 lbs	27.17" X 40.55" X 4.33"
UWTC006078	26.77" X 30.71"	23.23" X 30.51"	Dark Wood-Outdoor	30.467 lbs	27.17" X 40.55" X 4.33"
UWTC016078	26.77" X 30.71"	23.23" X 30.51"	Natural Wood-Indoor	23.545 lbs	27.17" X 40.55" X 4.33"
UWTC016078	26.77" X 30.71"	23.23" X 30.51"	Dark Wood-Indoor	23.545 lbs	27.17" X 40.55" X 4.33"



*W:Width H: Height D: Depth

Wall Mount Wooden Card Holder

new



See movie at our website www.mtdisplays.com.tr



Wall Mount Wooden Card Holder is designed to store and information packages in one convenient location. It is constructed of lacquered finished beech wood. Clear Acrylic pockets provide a full view of flyers or brochures stored in. The pockets are tiered one on top of each other. It provides you gain a wider area in offices, banks, schools, hospitals, hotels and more.



Each unit comes ready to use without any tool for assembly.



Complete with wall hangers.



Assembly time approx 30 seconds.

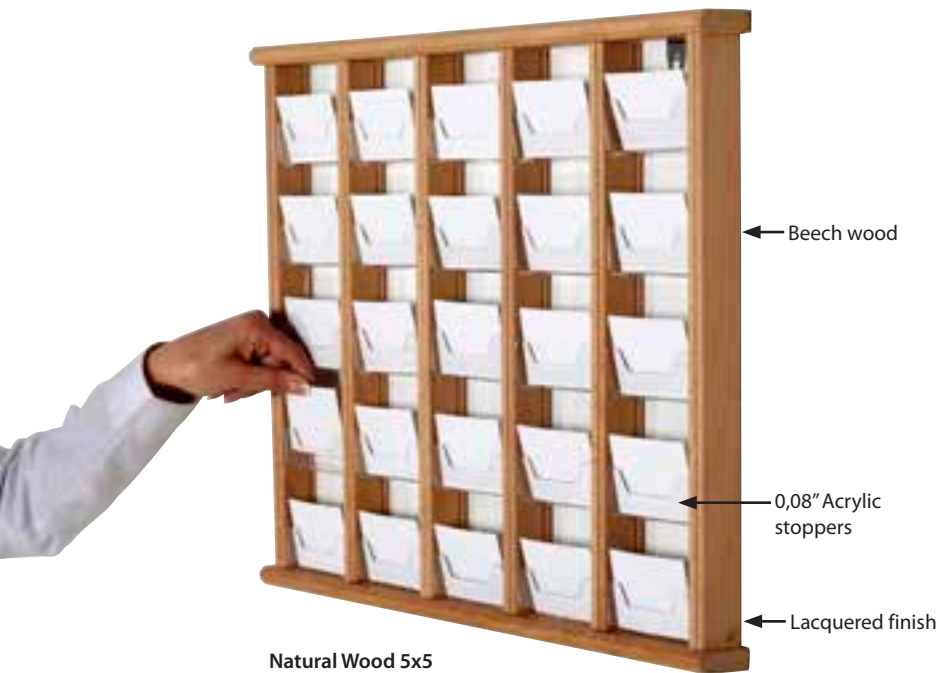

Natural Wood 5x5



Dark Wood 3x5

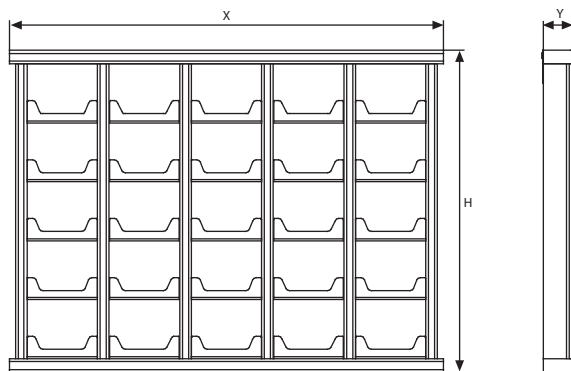

MATERIAL : Beech wood						WEIGHT	PACKING SIZE
ARTICLE	CAPACITY	DESCRIPTION	X	Y	H	WITH PACKING	*W X H X D
UWCHWN0035	3 X 5	Natural Wood	14.57"	1.57"	17.32"	5.732 lbs	15.75" X 18.50" X 2.36"
UWCHWN0055	5 X 5	Natural Wood	23.23"	1.57"	17.32"		18.11" X 24.02" X 2.36"
UWCHWD0035	3 X 5	Dark Wood	14.57"	1.57"	17.32"	5.732 lbs	15.75" X 18.50" X 2.36"
UWCHWD0055	5 X 5	Dark Wood	23.23"	1.57"	17.32"		18.11" X 24.02" X 2.36"

* W:Width H: Height D: Depth



Desktop Wooden Card Holder

new



See movie at our website www.mtdisplays.com.tr

Desktop Wooden Card Holder is designed to store and organize business cards, folded brochures and maps in one convenient location for busy areas. It is constructed of lacquered finished beech wood. The pockets are tiered one on top of each other showing enough of stored card or brochure. It provides you gain a wider area in offices, banks, travel agents, hospitals, hotels and more. Folded flaps provides flat packing and comfort for storage. Slide in support bar keeps the unit stable in use.



Each unit comes ready to use without any tool for assembly.



Complete with flaps and support bar.

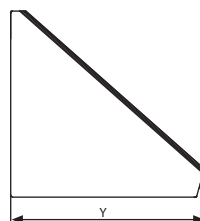
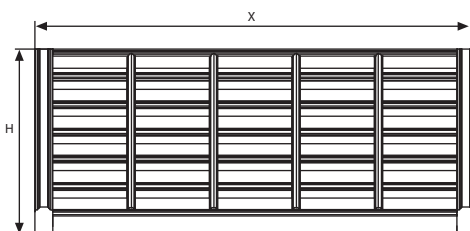
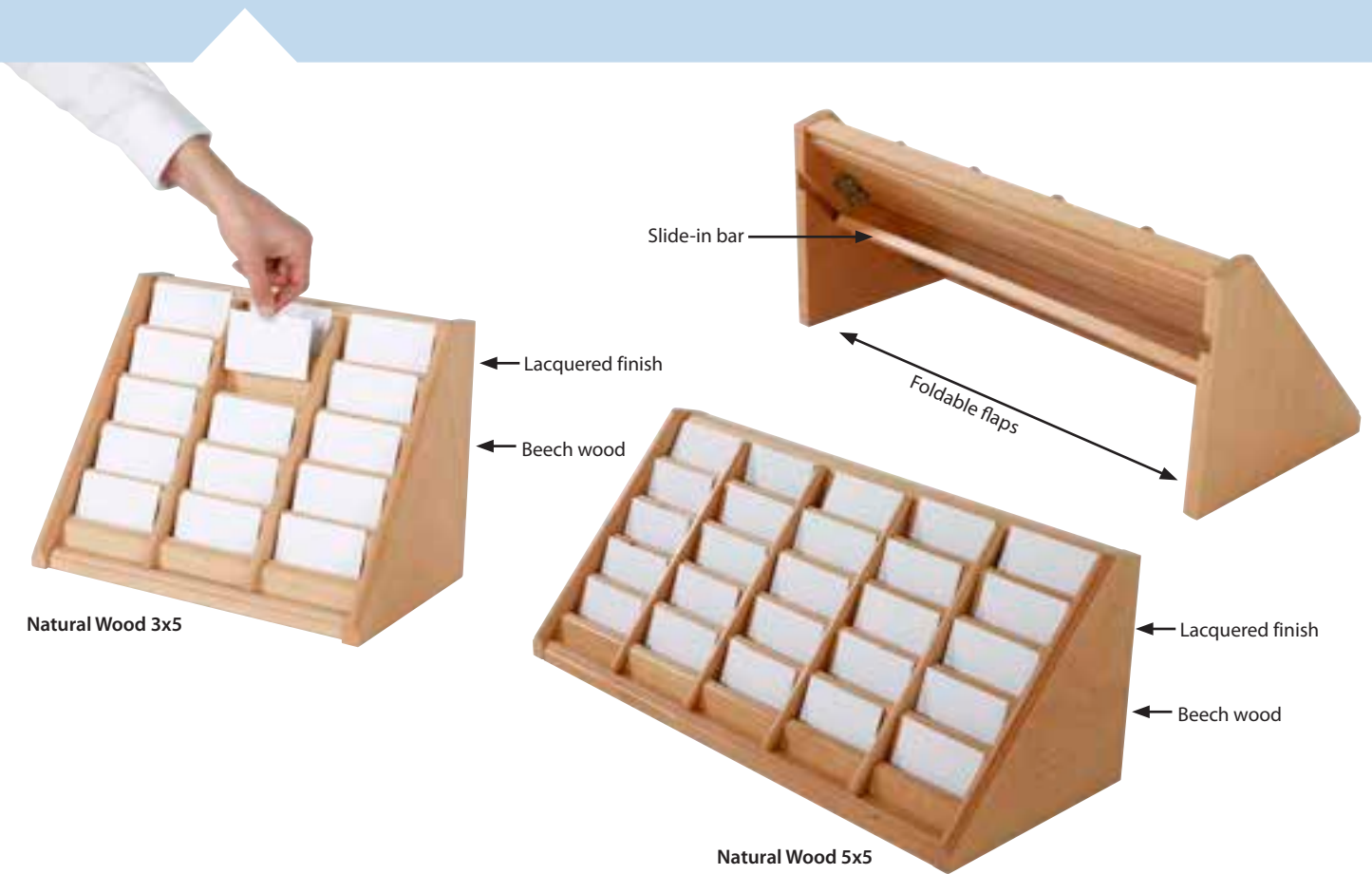

MATERIAL : Beech wood						WEIGHT	PACKING SIZE
ARTICLE	CAPACITY	DESCRIPTION	X	Y	H	WITH PACKING	*W X H X D
UWCHDN0035	3 X 5	Natural Wood	13.39"	9.45"	8.98"		14.17" X 15.75" X 3.15"
UWCHDN0055	5 X 5	Natural Wood	21.26"	9.45"	8.98"		14.17" X 23.62" X 3.15"

*W:Width H: Height D: Depth







Wood Magazine Rack for Wall

new



See movie at our website www.mtdisplays.com.tr

Wood Magazine Rack for Wall is designed to store and organize magazines, catalogs, flyers and information packages in one convenient location. It is one of the best and space saving organizers for busy areas. Back and sides are constructed of lacquered finished beech wood. Clear PET G pockets provide a full view of flyers or brochures stored in. The pockets are tiered one on top of each other. It provides you gain a wider area in travel agents, offices, banks, schools, hospitals, hotels and more. Mountseasily on the wall.

-  Product is packed assembled.
-  Complete with wall hangers.
-  No tool assembly & ready to use.
-  Assembly time approx 80 seconds.



Natural Wood 1x5 (8.5"x11")

Dark Wood 2x5 (8.5"x11")

Natural Wood 3x5 (8.5"x11")

Dark Wood 4x5 (8.5"x11")

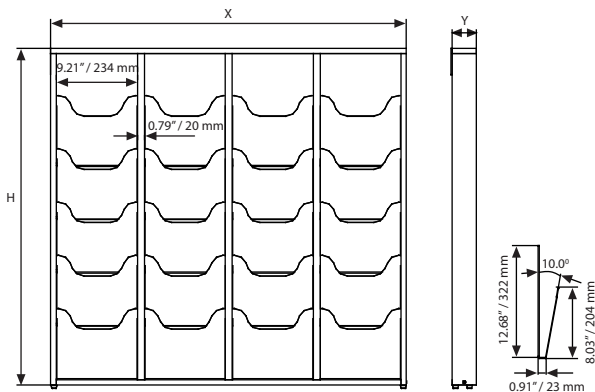

MATERIAL : Beech wood								WEIGHT	PACKING SIZE
ARTICLE	POSTER SIZE	CAPACITY	DESCRIPTION	X	Y	H	WITH PACKING	*W X H X D	
UWMRWN15A4	5 X (8.5"X11")	1 X 5 (8.5"X11")	Natural Wood	10.43"	2.95"	38.03"		11.42" X 41.34" X 3.54"	
UWMRWN25A4	10 X (8.5"X11")	2 X 5 (8.5"X11")	Natural Wood	20.47"	2.95"	38.03"		21.26" X 41.34" X 3.54"	
UWMRWN35A4	15 X (8.5"X11")	3 X 5 (8.5"X11")	Natural Wood	30.51"	2.95"	38.03"		31.50" X 41.34" X 3.54"	
UWMRWN45A4	20 X (8.5"X11")	4 X 5 (8.5"X11")	Natural Wood	40.16"	2.95"	38.03"		41.54" X 41.34" X 3.54"	
UWMRWD15A4	5 X (8.5"X11")	1 X 5 (8.5"X11")	Dark Wood	10.43"	2.95"	38.03"		11.42" X 41.34" X 3.54"	
UWMRWD25A4	10 X (8.5"X11")	2 X 5 (8.5"X11")	Dark Wood	20.47"	2.95"	38.03"		21.26" X 41.34" X 3.54"	
UWMRWD35A4	15 X (8.5"X11")	3 X 5 (8.5"X11")	Dark Wood	30.51"	2.95"	38.03"		31.50" X 41.34" X 3.54"	
UWMRWD45A4	20 X (8.5"X11")	4 X 5 (8.5"X11")	Dark Wood	40.16"	2.95"	38.03"		41.54" X 41.34" X 3.54"	

*W:Width H: Height D: Depth



Free Standing Wood Magazine Rack





new



See movie at our website www.mtdisplays.com.tr



Free Standing Wood Magazine Rack is designed to store and organize magazines, catalogs, flyers and information packages in one convenient location. Back and sides are constructed of lacquered finished beech wood. Clear PET G pockets provide a full view of flyers or brochures stored in. The pockets are tiered one on top of each other. It provides you gain a wider area in offices, banks, schools, hospitals, hotels and more.

-  Product is packed unassembled with an easy to understand instruction for assembly.
-  Complete with fixing components.
-  Easy to assemble.
-  Assembly time approx 30 seconds.

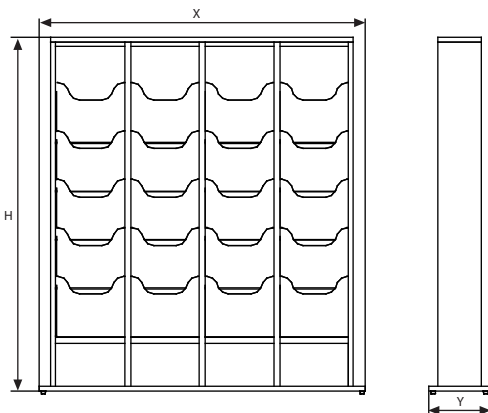
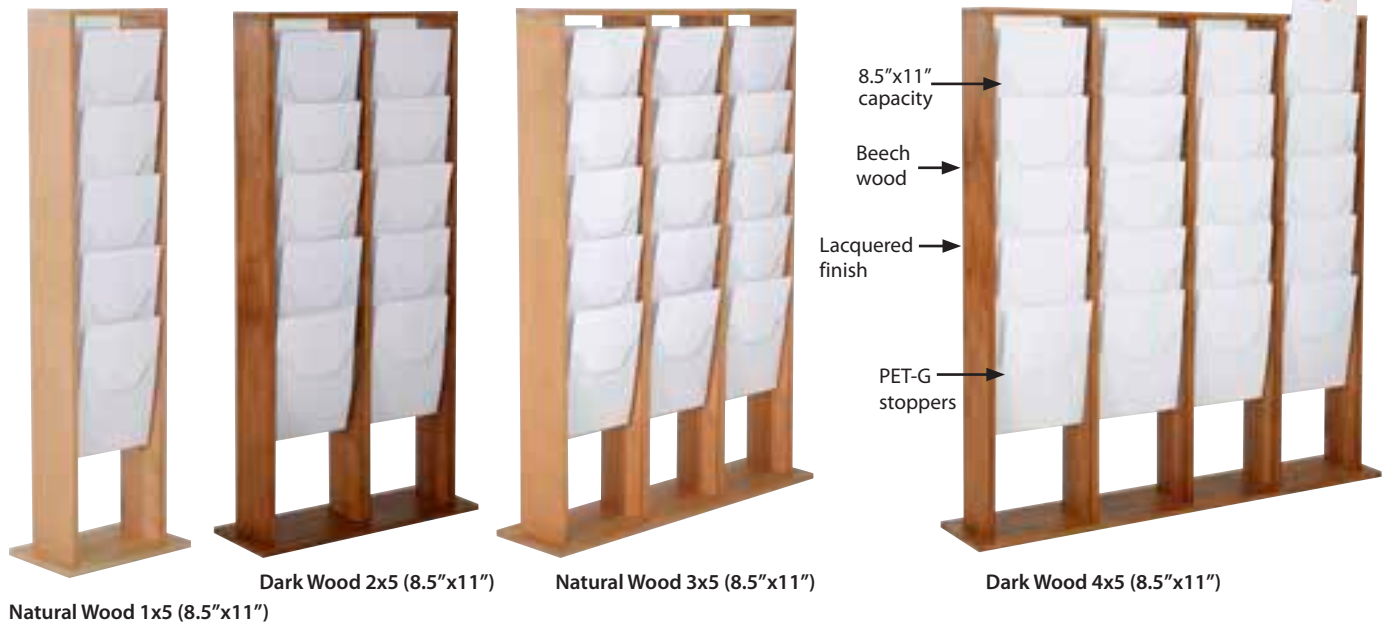

MATERIAL : Beech wood							WEIGHT	PACKING SIZE
ARTICLE	POSTER SIZE	CAPACITY	DESCRIPTION	X	Y	H	WITH PACKING	*W X H X D
UWMRFN15A4	10 X (8.5"X11")	1 X 5 (8.5"X11")	Natural Wood	13.58"	8.07"	46.26"		11.42" X 46.85" X 7.68"
UWMRFN25A4	20 X (8.5"X11")	2 X 5 (8.5"X11")	Natural Wood	23.62"	8.07"	46.26"		21.65" X 46.85" X 7.68"
UWMRFN35A4	30 X (8.5"X11")	3 X 5 (8.5"X11")	Natural Wood	33.27"	8.07"	46.26"		31.50" X 46.85" X 7.68"
UWMRFN45A4	40 X (8.5"X11")	4 X 5 (8.5"X11")	Natural Wood	42.91"	8.07"	46.26"		41.54" X 46.85" X 7.68"
UWMRFD15A4	10 X (8.5"X11")	1 X 5 (8.5"X11")	Dark Wood	13.58"	8.07"	46.26"		11.42" X 46.85" X 7.68"
UWMRFD25A4	20 X (8.5"X11")	2 X 5 (8.5"X11")	Dark Wood	23.62"	8.07"	46.26"		21.65" X 46.85" X 7.68"
UWMRFD35A4	30 X (8.5"X11")	3 X 5 (8.5"X11")	Dark Wood	33.27"	8.07"	46.26"		31.50" X 46.85" X 7.68"
UWMRFD45A4	40 X (8.5"X11")	4 X 5 (8.5"X11")	Dark Wood	42.91"	8.07"	46.26"		41.54" X 46.85" X 7.68"

*W:Width H: Height D: Depth







Wood Podium

new



See movie at our website www.mtdisplays.com.tr

Wood Podium is made of Beech plywood wood. It is a good lectern solution with 15 degrees viewing angle for ergonomic posture. It has an interior shelf for keeping notes and presentation materials organized. Poster clamp in front of the stand allows you to present your brand's logo for a professional fixture. Can be used at business conferences, universities, hotels, or even trade shows. To ensure sustainability of the quality, wood podium holders are lacquered finished.

-  Packed unassembled with an easy-to-understand instruction sheet & fixing elements.
-  With and without wheel options are available.
-  10 mm poster is placed within the clamping system. End caps help to slide the poster in and keeps.
-  1 pack. See info chart for pack sizes.
-  Assembly time approx 120 seconds.



Black without wheels



Black with wheels

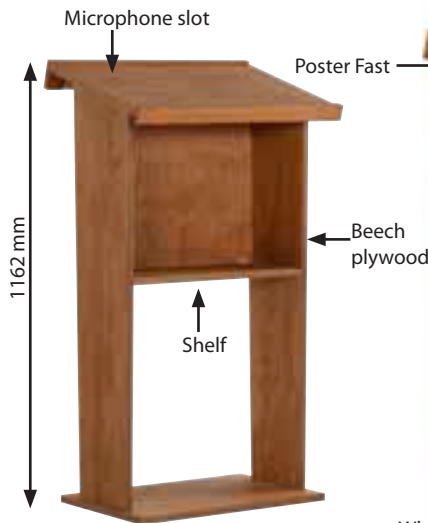

Dark Wood without wheels



Dark Wood with wheels

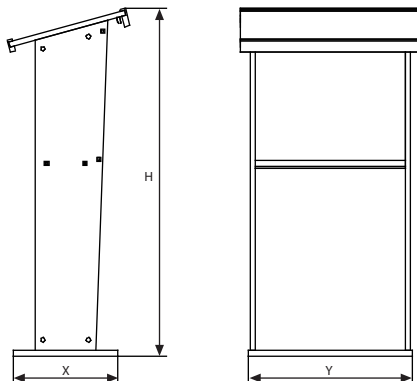

MATERIAL : Beech plywood					WEIGHT	PACKING SIZE
ARTICLE	DESCRIPTION	X	Y	H	WITH PACKING	*W X H X D
UWPDD00000	Dark Wood	13.78"	21.65"	45.75"		20.08" X 44.88" X 3.74"
UWPDB00000	Black	13.78"	21.65"	45.75"		20.08" X 44.88" X 3.74"



* W:Width H: Height D: Depth

Foldable Wood Box





new



See movie at our website www.mtdisplays.com.tr



Foldable Wood Box is made of solid pine wood. Suitable for use in restaurants, cafés and various retail stores for decorative purpose or separate different areas. Can be used for store items like plants, pottery, or other decorative items. Rustic look makes these wood boxes both practical and decorative. 2 rope handles on each side help to hold the box.

-  Packed unassembled with an easy-to-understand instruction sheet & fixing elements.
-  No tool assembly.
-  Once mounted, can't be dismantled.
-  1 pack. See info chart for pack sizes.
-  Assembly time approx 20 seconds.



Flat pack

MATERIAL : Pine wood			WEIGHT	PACKING SIZE
ARTICLE	SIZE	DESCRIPTION	WITH PACKING	*W X H X D
UWFBM01116	11"X16"X6"	Dark Wood		
UWFBM01420	14"X20"X8"	Dark Wood		
UWFBM01432	14"X32"X8"	Dark Wood		
UWFBM01445	14"X45"X8"	Dark Wood		
UWFBM02050	20"X50"X8"	Dark Wood		

*W:Width H: Height D: Depth





Stanchions

- Q Belt
- Q Belt for Wall
- Retractable Stanchion Crowd Control Posts
- Crowd Control Stanchion Poles & Ropes
- Q Rope
- Street Barrier



Q Belt



See movie at our website www.mtdisplays.com.tr



Retractable crowd control system, Q Belt, is ready to use in place which offers a choice of post finishes combined with a selection of belt colours. It is suitable to be used wherever people come together. Such as airports, cinema halls, hotels, museums etc. 4 way pole provides the flexibility to create the optimum pedestrian flow. Retractable tape is controlled with tension to keep the tape straight when the tape is moved or pulled out. Q Belt is constructed from sturdy, durable steel. It features with rubberized and heavy weight base.

114.17 tape (+/- 1.97") is available in 3 colour: Black, Red and Blue.

Post and base is available in Silver, Chrome and Black.

Tape is suitable for branding in printing size of max 1.57"x106.30". Belt length may change between 82.68"-114.17" depending on belt color and double side printing option and print design.

2 packs. See info chart for pack sizes.

Choice of 3 Belt colours:



Accessories available!

Available only 8.5"x11" Landscape & Portrait

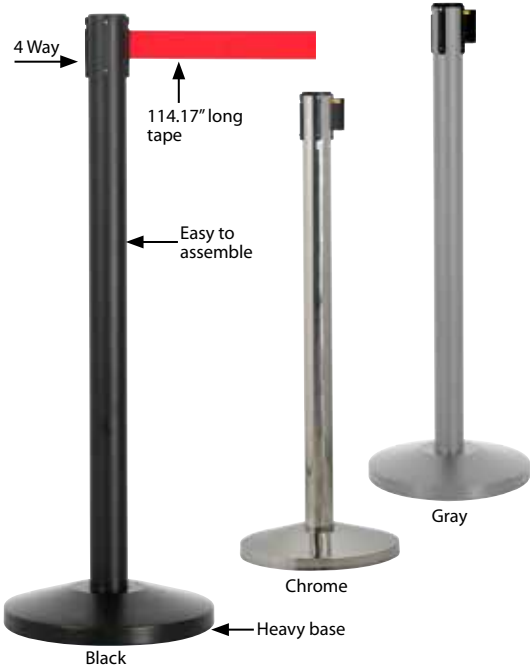

HEADER: Acrylic		WEIGHT	PACKING SIZE
ARTICLE	DESCRIPTION	WITHPACKING	*W X H X D
UQBL0011A4	Portrait, 8.5"X 11"	1,000 kg	245 X 335 X 75 mm
UQBL0012A4	Landscape, 8.5"X 11"	1,000 kg	245 X 335 X 75 mm

HEADER: Sign Frame		WEIGHT	PACKING SIZE
ARTICLE	DESCRIPTION	WITHPACKING	*W X H X D
TWBSFH0305	Barrier Sign Frame, Horizontal, Black 8.5"X 11"	1,500 kg	350 X 410 X 80 mm
TWBSFV0305	Barrier Sign Frame, Vertical, Black 8.5"X 11"	1,500 kg	260 X 490 X 80 mm
TWBASF0405	Adaptor Of Sign Frame		80 X 130 X 85 mm

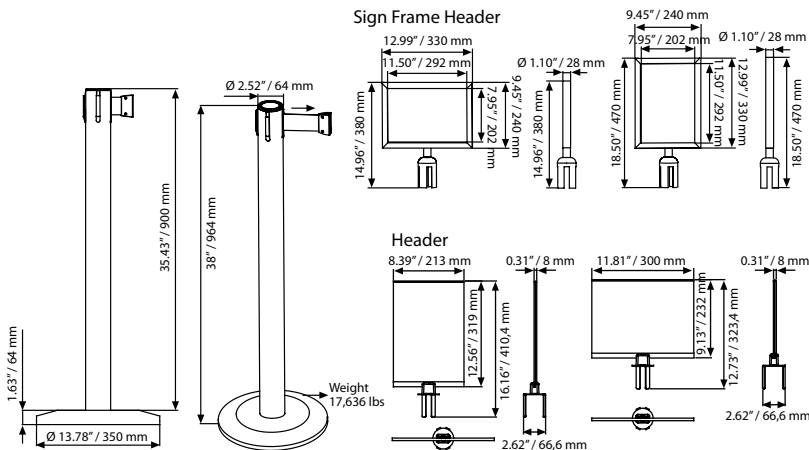

MATERIAL : Steel post		WEIGHT	PACKING SIZE
ARTICLE	DESCRIPTION	WITHPACKING	*W X H X D
UQBL01BB00	Black-Black Tape	20.635 lbs	3.94" X 38.19" X 4.92" / 15.35" X 15.35" X 2.36"
UQBL01BR00	Black-Red Tape	20.635 lbs	3.94" X 38.19" X 4.92" / 15.35" X 15.35" X 2.36"
UQBL01BL00	Black-Blue Tape	20.635 lbs	3.94" X 38.19" X 4.92" / 15.35" X 15.35" X 2.36"
UQBL01GB00	Grey-Black Tape	20.635 lbs	3.94" X 38.19" X 4.92" / 15.35" X 15.35" X 2.36"
UQBL01GR00	Grey-Red Tape	20.635 lbs	3.94" X 38.19" X 4.92" / 15.35" X 15.35" X 2.36"
UQBL01GL00	Grey-Blue Tape	20.635 lbs	3.94" X 38.19" X 4.92" / 15.35" X 15.35" X 2.36"
UQBL01CB00	Chrome-Black Tape	20.635 lbs	3.94" X 38.19" X 4.92" / 15.35" X 15.35" X 2.36"
UQBL01CR00	Chrome-Blue Tape	20.635 lbs	3.94" X 38.19" X 4.92" / 15.35" X 15.35" X 2.36"
UQBL01CL00	Chrome-Red Tape	20.635 lbs	3.94" X 38.19" X 4.92" / 15.35" X 15.35" X 2.36"

*W:Width H: Height D: Depth



Q Belt For Wall





Q Belt for Wall saves space in the busy environments. Made of strong and durable plastic, it is easy to fix on the wall.

 Wall connection is supplied with screws and receiver.

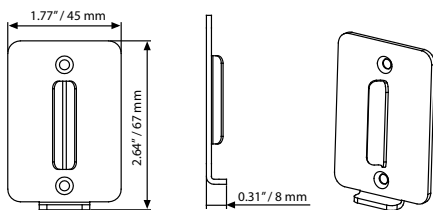
 Available only in black.



MATERIAL : Steel	
ARTICLE	DESCRIPTION
UQBLOWC00	Black wall connection

Retractable Stanchion Crowd Control Posts



See movie at our website www.mtdisplays.com.tr



Made of stainless steel, Stanchion with Smart Retractable Belt has heavy decorative base. 118.11" long retractable belt has Red and Blue options. Post options are Titanium Gold or Chrome Polish. Suitable for receptions, airports, cinema and theatre ticket windows, museums and more.

118.11" tape (+/- 1.97") is available in 2 colour: Red and Blue.

Post and base is available in Silver, Chrome, Black and White.

Tape is suitable for branding in printing size of max 1.57"x106.30".

2 packs. See info chart for pack sizes.

Choice of 3 Belt colours:

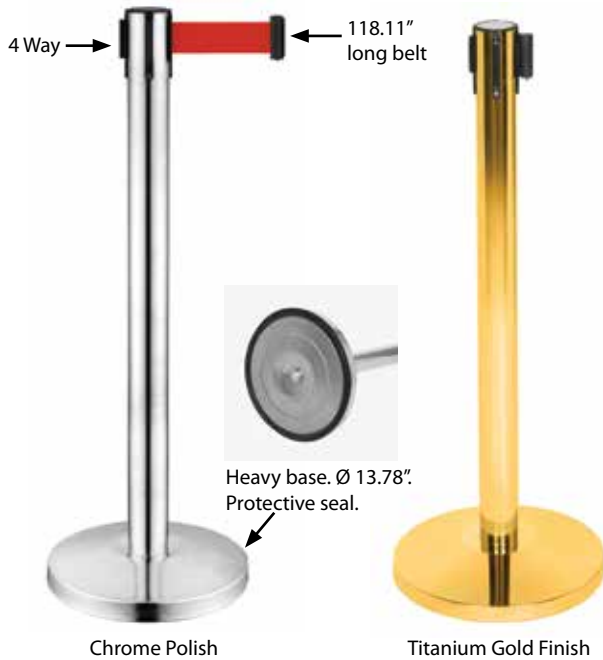

Accessories available!

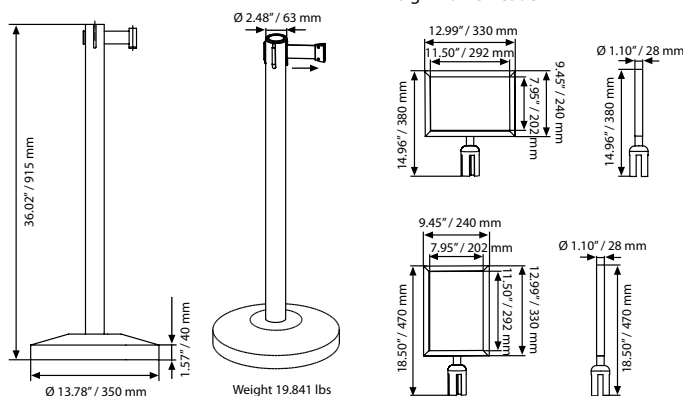

HEADER: Sign Frame		WEIGHT	PACKING SIZE
ARTICLE	DESCRIPTION	WITHPACKING	*W X H X D
TWBSFH0305	Barrier Sign Frame, Horizontal, Black 8.5"X11"	3.306 lbs	13.78" X 16.14" X 3.15"
TWBSFV0305	Barrier Sign Frame, Vertical, Black 8.5"X11"	3.306 lbs	10.24" X 19.29" X 3.15"
TWBASF0405	Adaptor Of Sign Frame		3.15" X 5.12" X 3.35"

MATERIAL : Stainless steel post		WEIGHT	PACKING SIZE
ARTICLE	DESCRIPTION	WITHPACKING	*W X H X D
TWBSTG0101	Titanium Gold Finish - Retractable Red Belt	9,000 kg	90 X 1070 X 95 mm / 380 X 380 X 75 mm
TWBSTG0102	Titanium Gold Finish - Retractable Blue Belt	9,000 kg	90 X 1070 X 95 mm / 380 X 380 X 75 mm
TWBSCP0101	Chrome Polish - Retractable Red Belt	9,000 kg	90 X 1070 X 95 mm / 380 X 380 X 75 mm
TWBSCP0102	Chrome Polish - Retractable Blue Belt	9,000 kg	90 X 1070 X 95 mm / 380 X 380 X 75 mm

*W:Width H:Height D:Depth



Crowd Control Stanchion Poles & Ropes



Made of stainless steel, Crown Top Stanchion has heavy decorative base. 118.11" long twisted rope has red, blue and black options. Post options are Titanium Gold or Chrome Polish. Suitable for receptions, airports, cinema and theatre ticket windows, museums and more.

- Please order the rope individually.
- Post and base is available in titanium gold or chrome polish.
- 2 packs. See info chart for pack sizes.

Choice of 3 Belt colours:

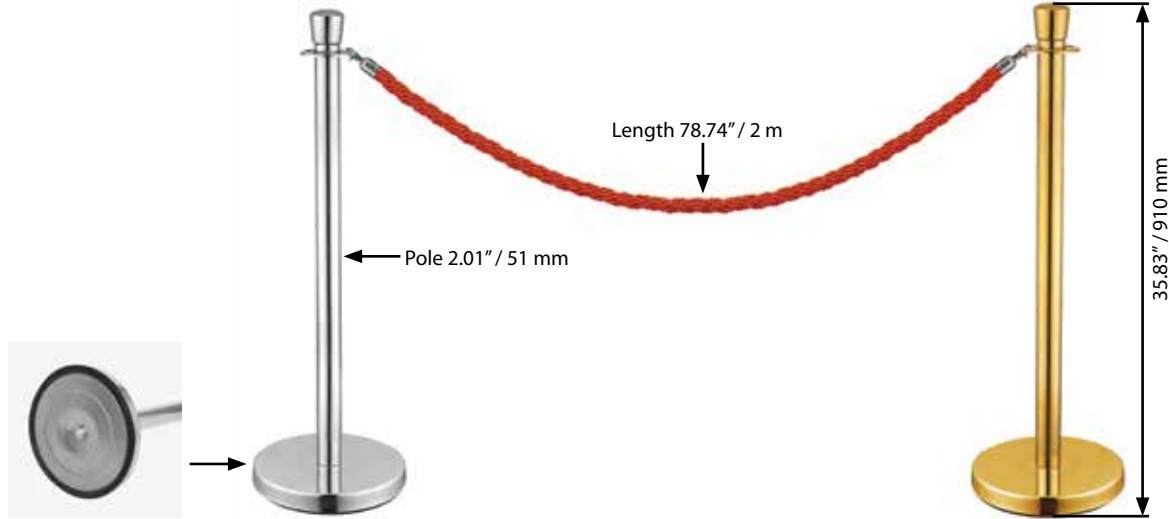

Heavy base.
Ø 13.78" / 350 mm.
Protective seal.

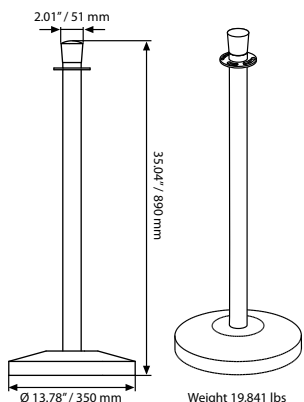
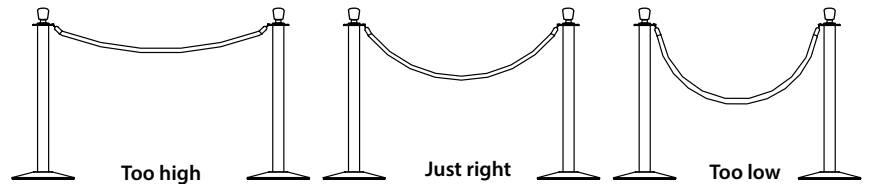

Blue-Chrome
Length 78.74"



Black-Chrome
Length 78.74"



Red-Chrome
Length 78.74"



Red-Gold
Length 118.11"

MATERIAL : Stainless steel post		WEIGHT	PACKING SIZE
ARTICLE	DESCRIPTION	WITHPACKING	*W X H X D
TWBCTT05P3	Q Rope Basic Titanium Gold Post w/out Rope	19.841 lbs	4.53" X 37.80" X 4.72" - 13.39" X 13.39" X 2.95"
TWBCTC05P4	Q Rope Basic Chrome Polish Post w/out Rope	19.841 lbs	4.53" X 37.80" X 4.72" - 13.39" X 13.39" X 2.95"
TWBCTT05C3	Q Rope Basic Titanium Gold Crown Top w/out Rope	19.841 lbs	4.53" X 37.80" X 4.72" - 13.39" X 13.39" X 2.95"
TWBCTC05C4	Q Rope Basic Chrome Polish Crown Top w/out Rope	19.841 lbs	4.53" X 37.80" X 4.72" - 13.39" X 13.39" X 2.95"
TWBCTT05B3	Q Rope Basic Titanium Gold Base w/out Rope	19.841 lbs	4.53" X 37.80" X 4.72" - 13.39" X 13.39" X 2.95"
TWBCTC05B4	Q Rope Basic Chrome Polish Base w/out Rope	19.841 lbs	4.53" X 37.80" X 4.72" - 13.39" X 13.39" X 2.95"
UQRPOOL000	Blue-Chrome Rope	2.094 lbs	4.72" X 18.11" X 3.74"
UQRPO0B000	Black-Chrome Rope	2.094 lbs	4.72" X 18.11" X 3.74"
UQRPO0R000	Red-Chrome Rope	2.094 lbs	4.72" X 18.11" X 3.74"
TWBTRT0201	Red-Gold Rope	3,306 lbs	3.94" X 31.50" X 2.76"





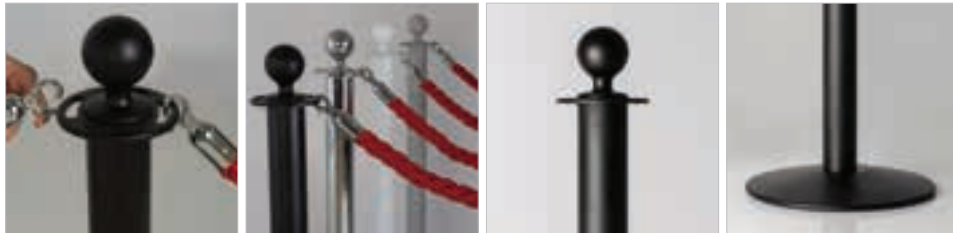

*W:Width H: Height D: Depth

Q Rope Knob Top



Strong and high quality Q Rope is ready to use. It is constructed from sturdy, durable steel. 4-way pole provides flexibility for the use. Ideal in banks, hotels, receptions, retail shops and anywhere that required a crowd management system. Contemporary finish of the pole with knob-flat-top offers differentiation. Q Rope incorporate twisted design barrier rope, which looks high quality and professional. It features with rubberized base.

-  2mt rope is available in 3 colour: Black, Red and Blue.
-  Post and base is available in Gray, Chrome, Black and White.
-  Sold as individual components.
-  2 packs. See info chart for pack sizes.

Choice of 3 Belt colours:

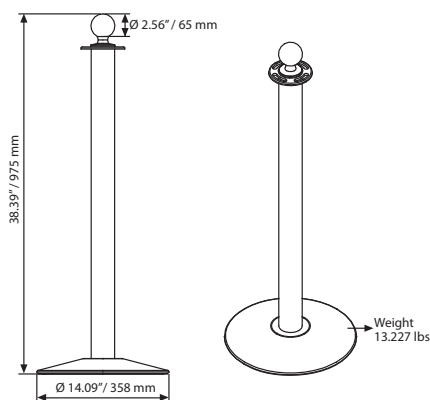
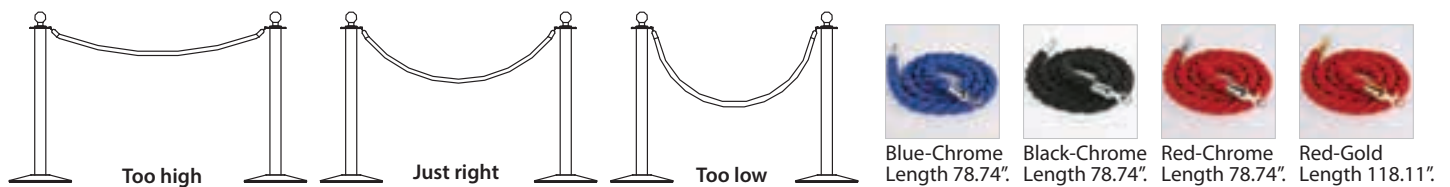
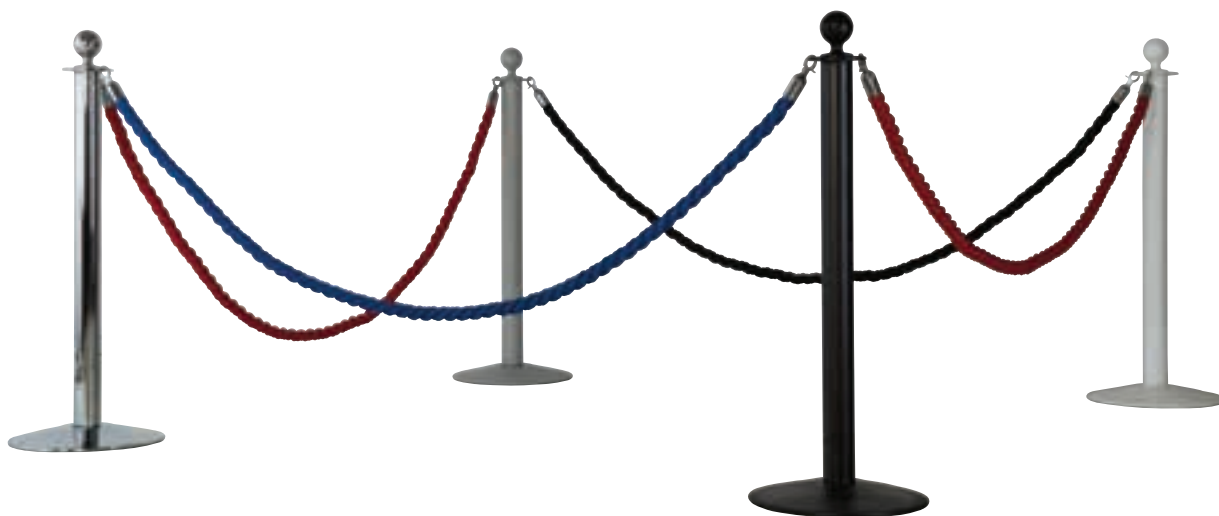

MATERIAL : Steel		WEIGHT	PACKING SIZE
ARTICLE	DESCRIPTION	WITHPACKING	*W X H X D
UQRPP1B010	Black - Knob Top. W/out Weight W/out Rope	13.778 lbs	5.51" X 38.19" X 5.51" / 15.35" X 15.35" X 2.36"
UQRPP1G010	Grey - Knob Top. W/out Weight W/out Rope	13.778 lbs	5.51" X 38.19" X 5.51" / 15.35" X 15.35" X 2.36"
UQRPP1C010	Chrome - Knob Top. W/out Weight W/out Rope	13.778 lbs	5.51" X 38.19" X 5.51" / 15.35" X 15.35" X 2.36"
UQRPP1W010	White - Knob Top. W/out Weight W/out Rope	13.778 lbs	5.51" X 38.19" X 5.51" / 15.35" X 15.35" X 2.36"
UQRPOOL000	Blue-Chrome / only rope	2.094 lbs	4.72" X 18.11" X 3.74"
UQRPOOB000	Black-Chrome / only rope	2.094 lbs	4.72" X 18.11" X 3.74"
UQRPOOR000	Red-Chrome / only rope	2.094 lbs	4.72" X 18.11" X 3.74"
TWBTRT0201	Red-Gold / only rope	2.094 lbs	4.72" X 18.11" X 3.74"





*W:Width H: Height D: Depth



Q Rope Flat Top



Strong and high quality Q Rope is ready to use. It is constructed from sturdy, durable steel. 4-way pole provides flexibility for the use. Ideal in banks, hotels, receptions, retail shops and anywhere that required a crowd management system. Contemporary finish of the pole with knob-flat-top offers differentiation. Q Rope incorporate twisted design barrier rope, which looks high quality and professional. It features with rubberized base.

-  2mt rope is available in 3 colour: Black, Red and Blue.
-  Post and base is available in Gray, Chrome, Black and White.
-  Sold as individual components.
-  2 packs. See info chart for pack sizes.

Choice of 3 Belt colours:

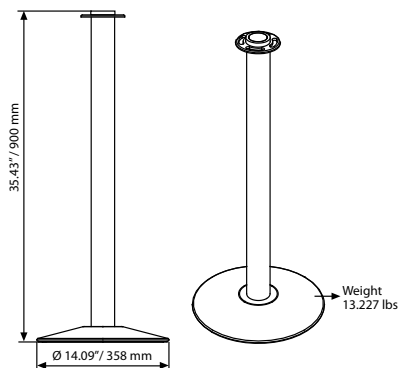
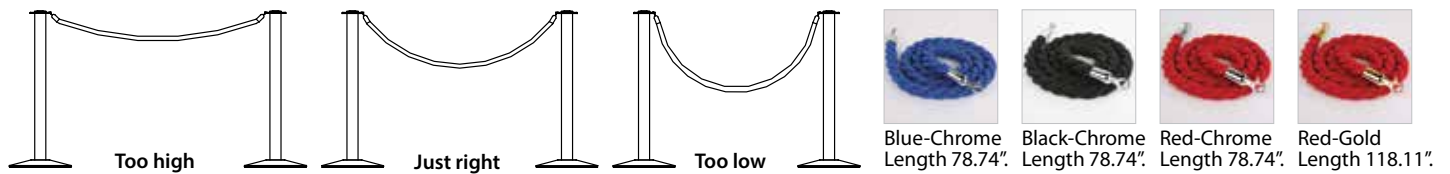

MATERIAL : Steel		WEIGHT	PACKING SIZE
ARTICLE	DESCRIPTION	WITHPACKING	*W X H X D
UQRPP1B020	Black - Flat Top. W/out Weight W/out Rope	13.778 lbs	5.51" X 38.19" X 5.51" / 15.35" X 15.35" X 2.36"
UQRPP1G020	Grey - Flat Top. W/out Weight W/out Rope	13.778 lbs	5.51" X 38.19" X 5.51" / 15.35" X 15.35" X 2.36"
UQRPP1C020	Chrome - Flat Top. W/out Weight W/out Rope	13.778 lbs	5.51" X 38.19" X 5.51" / 15.35" X 15.35" X 2.36"
UQRPP1W020	White - Flat Top. W/out Weight W/out Rope	13.778 lbs	5.51" X 38.19" X 5.51" / 15.35" X 15.35" X 2.36"
UQRP00L000	Blue-Chrome / only rope	2.094 lbs	4.72" X 18.11" X 3.74"
UQRP00B000	Black-Chrome / only rope	2.094 lbs	4.72" X 18.11" X 3.74"
UQRP00R000	Red-Chrome / only rope	2.094 lbs	4.72" X 18.11" X 3.74"
TWBTRT0201	Red-Gold / only rope	2.094 lbs	4.72" X 18.11" X 3.74"

* W:Width H: Height D: Depth



Street Barrier



See movie at our website www.mtdisplays.com.tr



Large format Street Barriers create a unique space by making the advertising stand out. As it is constructed by steel, it is heavy and suitable for outdoor use. Available in 42"x24" and 65"x24" as standard.

O rings included in the product.

Stain free outdoor powder coating metal.

Eye lets are not included with the product.



Included in the packed.



Unassembled feet.



8.818 lbs for each feet

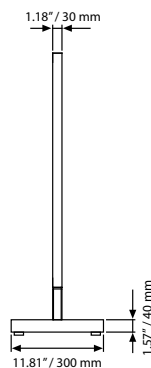
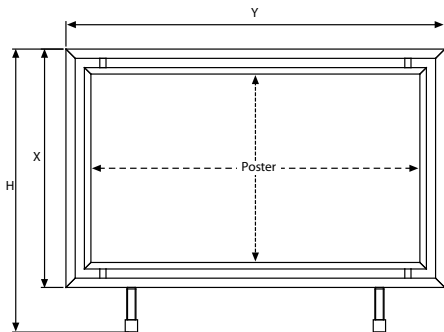

MATERIAL : Black powder coated					WEIGHT	PACKING SIZE
ARTICLE	EXTERNAL (x-y)	POSTER	H	DESCRIPTION	WITH PACKING	*W X H X D
UBSON00042	30.47" X 48.46"	24" X 42"	36.18"	Gray	35.273 lbs	37.80" X 49.61" X 1.97"
UBSON00065	30.47" X 71.46"	24" X 65"	36.18"	Gray	44.092 lbs	37.80" X 73.23" X 1.97"
UBSOB00042	30.47" X 48.46"	24" X 42"	36.18"	Black	35.273 lbs	37.80" X 49.61" X 1.97"
UBSOB00065	30.47" X 71.46"	24" X 65"	36.18"	Black	44.092 lbs	37.80" X 73.23" X 1.97"

*W:Width H: Height D: Depth





Exhibition Displays

- Crown Truss **NEW**
- Pop-up with Magnetic
- Panset
- Panset Hexagonal Counter
- Panset Convex Counter
- Midsize Convex Counter
- Foldable Wood Counter **NEW**
- Pop-up Counter
- Promostand
- Petite Promostand
- Seed Promostand
- Rectangular Promostand
- Circle Promostand
- Bean Promostand
- Tumble Box
- Puzzle Tumble Box
- Free Standing Puzzle Tumble Box



Crown Truss 15x15



See movie at our website www.mtdisplays.com.tr



A modular truss system with unlimited possibilities. Made in strong and durable materials - aluminium, steel and composite. At the same time it is a lightweight and foldable truss construction.

The perfect function and unique design allow the creation of custom expressions fitted to your individual needs. Very easy to assemble, disassemble, pack and carry. Available as standard models as well as parts.

3D design allows creating your own stands: www.crown3d.net

Color options



Black White

- Design software is available on internet. Please ask for login details.
- 3 promotion packs are available; Sample Kit, Trolley Kit and Showroom Kits.
- Technical data sheet available on request.



Build your own display in 3D!

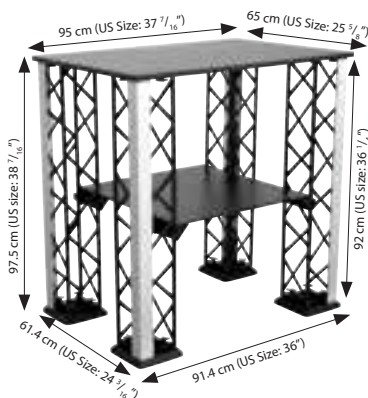

CROWN TRUSS COUNTER

BLACK	WHITE	MODEL
UCT15BSP00	UCT15WSP00	With shelf
UCT15BS010	UCT15WS010	Without shelf



Crown Truss Models 15x15



Model 768 / UCT15BM768

Truss L-Shape 3 x 3

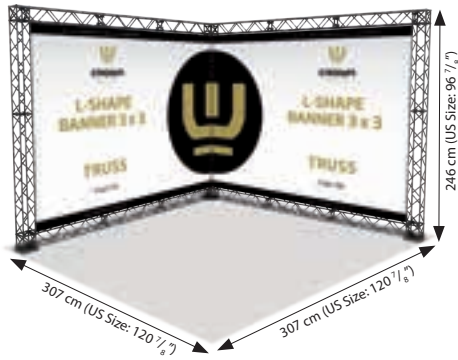

Model 771 / UCT15BM771

Truss U-Shape 4 x 4

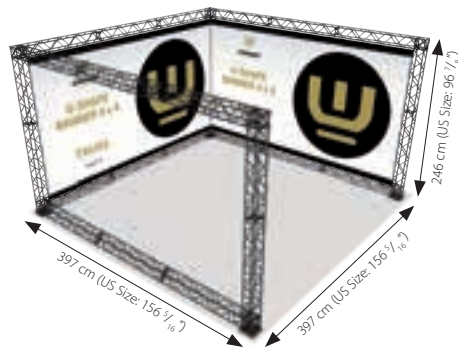

Model 772 / UCT15BM772

Truss L-Shape 5 x 5

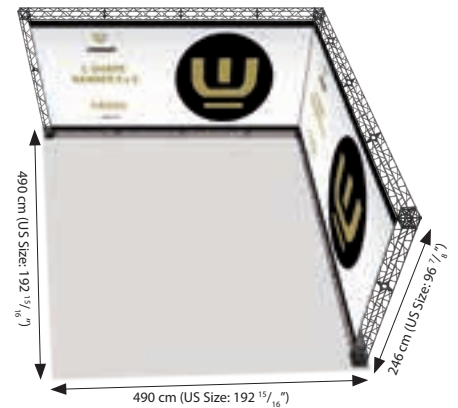

Model 775 / UCT15BM775

Truss U-Shape 4 x 6

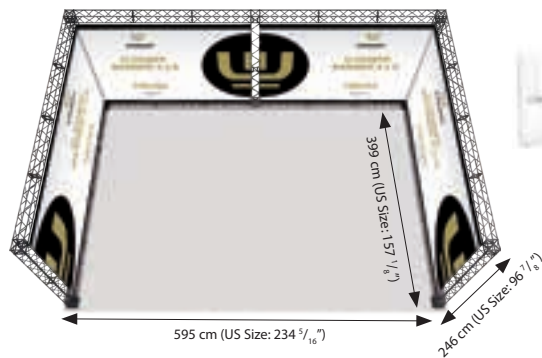

Crown Truss Parts 15x15

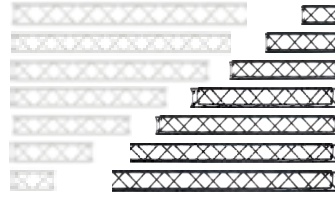

MODULE 150X150 MM			WEIGHT	PACKING SIZE (5 Pcs)
BLACK	WHITE	SIZE	WITH PACKING	*W X H X D
UCT15BM030	UCT15WM030	11 ^{13/16} "	10.042 lbs	11.22" X 12.99" X 8.27"
UCT15BM060	UCT15WM060	23 ^{5/8} "	16.226 lbs	11.22" X 24.80" X 8.27"
UCT15BM090	UCT15WM090	35 ^{7/16} "	22.409 lbs	11.22" X 36.61" X 8.27"
UCT15BM120	UCT15WM120	47 ^{1/4} "	28.593 lbs	11.22" X 48.43" X 8.27"
UCT15BM150	UCT15WM150	59 ^{1/16} "	34.777 lbs	11.22" X 60.24" X 8.27"
UCT15BM180	UCT15WM180	70 ^{7/8} "	40.961 lbs	11.22" X 72.05" X 8.27"
UCT15BM210	UCT15WM210	82 ^{11/16} "	47.145 lbs	11.22" X 83.86" X 8.27"



REGULAR BASE			WEIGHT	PACKING SIZE (5 Pcs)
BLACK	WHITE	SIZE	WITH PACKING	*W X H X D
UCT15BF220	UCT15WF220	7 ^{1/2} " X 7 ^{1/2} "	2.678 lbs	7.87" X 7.87" X 5.91"

SIDE BASE			WEIGHT	PACKING SIZE (5 Pcs)
BLACK	WHITE	SIZE	WITH PACKING	*W X H X D
UCT15BF245	UCT15WF245	7 ^{1/2} " X 15 ^{3/4} "	4.784 lbs	7.68" X 17.13" X 4.92"

MIDDLE BASE			WEIGHT	PACKING SIZE (5 Pcs)
BLACK	WHITE	SIZE	WITH PACKING	*W X H X D
UCT15BF260	UCT15WF245	7 ^{1/2} " X 23 ^{5/8} "	6.613 lbs	7.68" X 25" X 4.92"

CORNER BLOCK		WEIGHT	PACKING SIZE (5 Pcs)
BLACK	WHITE	WITH PACKING	*W X H X D
UCT15BK00	UCT15WK00	11.464 lbs	12.60" X 18.50" X 6.69"

CONNECTOR CROSS		WEIGHT	PACKING SIZE (5 Pcs)
BLACK	WHITE	WITH PACKING	*W X H X D
UCT15BAE00	UCT15WAE00	1.322 lbs	6.69" X 6.69" X 3.15"

FOR BANNER HANGING		WEIGHT
ARTICLE	SIZE	WITH PACKING
UCT15BP030	11 ^{13/16} "	6.503 lbs
UCT15BP060	23 ^{5/8} "	13.007 lbs
UCT15BP090	35 ^{7/16} "	19.510 lbs
UCT15BP120	47 ^{1/4} "	26.014 lbs
UCT15BP150	59 ^{1/16} "	32.518 lbs
UCT15BP180	70 ^{7/8} "	39.021 lbs
UCT15BP210	82 ^{11/16} "	45.525 lbs

CLIP-ON FITTING		WEIGHT
BLACK	WHITE	WITH PACKING
UCT15BBT00	UCT15WBT00	2.425 lbs

CLIPS FOR BANNER			WEIGHT	PACKING SIZE (100 Pcs)
BLACK	WHITE	SIZE	WITH PACKING	*W X H X D
UCT15BAU00	UCT15WAU00	Top clips	1.278 lbs	5.12" X 8.07" X 4.33"
UCT15BAA00	UCT15WAA00	Bottom clips	1.488 lbs	5.12" X 8.07" X 4.33"



SHELF			WEIGHT	PACKING SIZE
BLACK	WHITE	SIZE	WITH PACKING	*W X H X D
UCT15BR062	UCT15WR062	23 ^{5/8} "	6.613 lbs	10.43" X 24.41" X 2.76"
UCT15BR092	UCT15WR092	35 ^{7/16} "	9.149 lbs	10.43" X 36.22" X 2.76"
UCT15BR122	UCT15WR122	47 ^{1/4} "	11.684 lbs	10.43" X 48.03" X 2.76"
UCT15BR152	UCT15WR152	59 ^{1/16} "	14.219 lbs	10.43" X 59.84" X 2.76"
UCT15BR440	UCT15WR440	L Shape	1.873 lbs	16.34" X 16.34" X 2.76"
UCT15BRT00	UCT15WRT00	Shelf holder	0.440 lbs	

ACRYLIC HOLDER			WEIGHT	PACKING SIZE (5 Pcs)
BLACK	WHITE	SIZE	WITH PACKING	*W X H X D
UCT15BB0A4	UCT15WB0A4	8 ^{1/2} " X 11"	3.880 lbs	10.43" X 12.01" X 9.25"
UCT15BB0A5	UCT15WB0A5	5 ^{1/2} " X 8 ^{1/2} "	2.491 lbs	7.28" X 10.83" X 6.98"
UCT15BB0A3	UCT15WB0A3	4" X 6"	2.050 lbs	6.98" X 6.98" X 7.28"



SPOTS		WEIGHT
ARTICLE	DESCRIPTION	WITH PACKING
UCT10BLT10	Spotlight 150 W	1.543 lbs
UCT15BLT00	Spotlight fitting-Black	0.705 lbs
UCT15WLT00	Spotlight fitting-White	0.705 lbs

*W:Width H: Height D: Depth

Crown Truss 10x10

new



Crown Truss System 10x10 is developed for the display and exhibition industry for modular and practical advertisement purpose. It is made of strong and durable materials; aluminium, steel and composite. At the same time it is a lightweight truss construction. Very easy to assemble, disassemble, pack and carry.



White and Black colours available.



Technical data sheet available on request.

Color options



Black White

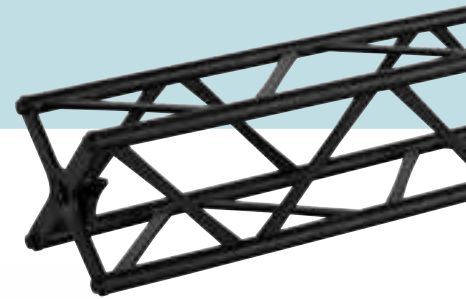

Crown Truss Parts 10x10

MODULE 100X100 MM			WEIGHT	PACKING SIZE (5 Pcs)
BLACK	WHITE	SIZE	WITH PACKING	*W X H X D
UCT10BM020	UCT10WM020	7 7/8"	5.996 lbs	4.92" X 20.67" X 10.04"
UCT10BM040	UCT10WM040	15 3/4"	8.708 lbs	4.92" X 20.67" X 17.91"
UCT10BM060	UCT10WM060	23 5/8"	11.464 lbs	4.92" X 20.67" X 25.79"
UCT10BM080	UCT10WM080	31 1/2"	14.219 lbs	4.92" X 20.67" X 33.66"
UCT10BM100	UCT10WM100	39 3/8"	16.755 lbs	4.92" X 20.67" X 41.54"
UCT10BM120	UCT10WM120	47 1/4"	19.731 lbs	4.92" X 20.67" X 49.41"
UCT10BM140	UCT10WM140	55 1/8"	22.487 lbs	4.92" X 20.67" X 57.28"
UCT10BM160	UCT10WM160	63"	25.132 lbs	4.92" X 20.67" X 65.16"
UCT10BM180	UCT10WM180	70 7/8"	27.888 lbs	4.92" X 20.67" X 73.03"
UCT10BM200	UCT10WM200	78 3/4"	30.644 lbs	4.92" X 20.67" X 80.91"

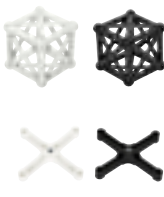
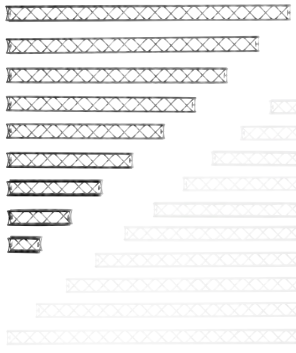

CORNER BLOCK		WEIGHT	PACKING SIZE (5 Pcs)
BLACK	WHITE	WITH PACKING	*W X H X D
UCT10BK00	UCT10WK00	7.517 lbs	4.92" X 4.92" X 21.85"

CONNECTOR CROSS (5 Pcs)		WEIGHT	PACKING SIZE (5 Pcs)
BLACK	WHITE	WITH PACKING	*W X H X D
UCT10BAE00	UCT10WAE00	0.705 lbs	4.92" X 4.92" X 4.13"

FOR BANNER HANGING		WEIGHT
ARTICLE	SIZE	WITH PACKING
UCT10BP020	7 7/8"	0.440 lbs
UCT10BP040	15 3/4"	0.881 lbs
UCT10BP060	31 1/2"	1.752 lbs
UCT10BP080	39 3/8"	2.182 lbs
UCT10BP120	55 1/8"	3.064 lbs
UCT10BP150	63"	3.494 lbs
UCT10BP180	78 3/4"	4.365 lbs

REGULAR BASE			WEIGHT	PACKING SIZE (5 Pcs)
BLACK	WHITE	SIZE	WITH PACKING	*W X H X D
UCT10BF220	UCT10WF220	7 1/2" X 7 1/2"	2.910 lbs	8.07" X 8.07" X 6.10"



SIDE BASE			WEIGHT	PACKING SIZE (5 Pcs)
BLACK	WHITE	SIZE	WITH PACKING	*W X H X D
UCT10BF245	UCT10WF245	7 1/2" X 15 3/4"	4.784 lbs	7.68" X 17.13" X 4.92"



MIDDLE BASE			WEIGHT	PACKING SIZE (5 Pcs)
BLACK	WHITE	SIZE	WITH PACKING	*W X H X D
UCT10BF260	UCT10WF245	7 1/2" X 23 5/8"	6.613 lbs	7.68" X 25" X 4.92"



ACRYLIC HOLDER			WEIGHT	PACKING SIZE (5 Pcs)
BLACK	WHITE	SIZE	WITH PACKING	*W X H X D
UCT10BB0A4	UCT10WB0A4	8 1/2" X 11"	3.880 lbs	10.43" X 12.01" X 9.25"
UCT10BB0A5	UCT10WB0A5	5 1/2" X 8 1/2"	2.491 lbs	7.28" X 10.83" X 6.98"
UCT10BB0A3	UCT10WB0A3	4" X 6"	2.050 lbs	6.98" X 6.98" X 7.28"



CLIPS FOR BANNER			WEIGHT	PACKING SIZE (100 Pcs)
BLACK	WHITE	SIZE	WITH PACKING	*W X H X D
UCT10BAU00	UCT10WAU00	Top clips	1.278 lbs	5.12" X 8.07" X 4.33"
UCT10BAA00	UCT10WAA00	Bottom clips	1.488 lbs	5.12" X 8.07" X 4.33"

SPOTS		WEIGHT
ARTICLE	DESCRIPTION	WITH PACKING
UCT10BLT10	Spotlight 150 W	1.543 lbs
UCT10BLT00	Spotlight fitting-Black	0.705 lbs
UCT10WLT00	Spotlight fitting-White	0.705 lbs

*W:Width H:Height D:Depth



Panset



Panset exhibition system is a portable & friendly assembled panel construction. The durable framework of Panset can be positioned between 0-360° The framework of the construction can be easily unassembled to permit a quick change of the panel inside. The Poster can easily change by laminating. Panset systems have a variety of sizes 3X3,3X4,3x5. Panset black carry bag main body for all size is available.

Application of the inner panels
Open the top profiles by using an allen key. Take out the unprinted panels. After the application of the printings on the panels, slide them into the construction through the channels on both sides. Fix the top profiles in the side channels as shown in the photo. Use the allen key to firm the positioning of profiles. Repeat the same process for all the panels. Fix the header panels on the second floor panels first. On last step place in the bottom floor with the top part. Here is the complete Exhibition stand.

 Please consider during planning that the visual area of the graphic panel will diminish by 0,5 cm on every side because of the profile covering.

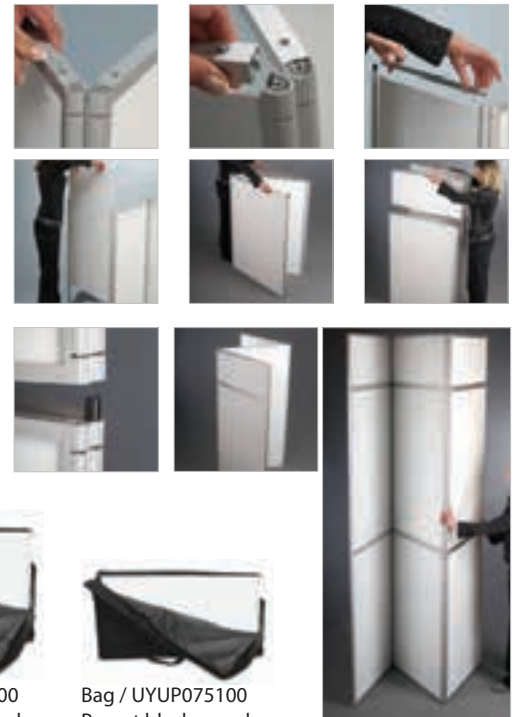

Bag / UYUP076100
Panset black carry bag main body for all size. Don't forget to order.



Bag / UYUP075100
Panset black carry bag for logo for all size. Don't forget to order.

3x5 / 3x4 / 3x3 Panset

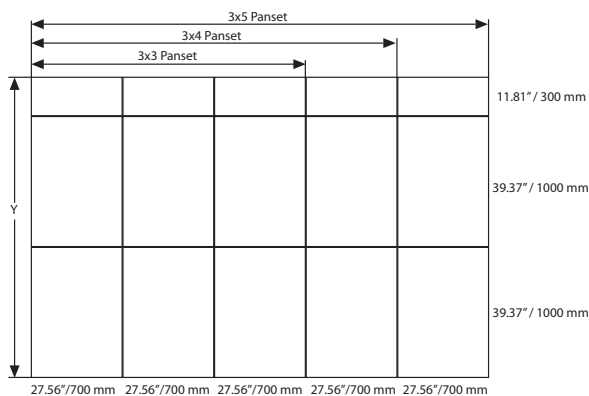

MATERIAL : Silver anodised aluminium PANEL: Plastech PVC Foam				WEIGHT	PACKING SIZE
ARTICLE	EXTERNAL (x-y)	PANEL	HEADER	WITH PACKING	*W X H X D
UPNS000035	137.80" X 90.55"	27.56" X 39.37"	11.81" X 27.56"	79.256 lbs	13.78" X 29.92" X 5.51"
					13.78" X 44.09" X 5.51"
					13.78" X 44.09" X 5.51"
UPNS000034	110.24" X 90.55"	27.56" X 39.37"	11.81" X 27.56"	65.102 lbs	13.78" X 29.92" X 4.72"
					13.78" X 44.09" X 4.72"
					13.78" X 44.09" X 4.72"
UPNS000033	82.68" X 90.55"	27.56" X 39.37"	11.81" X 27.56"	49.956 lbs	13.78" X 29.92" X 3.15"
					13.78" X 44.09" X 3.15"
					13.78" X 44.09" X 3.15"

*W:Width H: Height D: Depth



Pop-up with Magnetic



Pop-up stands with clips or magnetic are still the most popular standard display for large graphic displays. They are easy to transport, light weight, simple pop-ups and packable into a roto-molded plastic carry bag for transportation. Pop-up displays have a variety of sizes 3x3, 3x4. Panels are fitted to create a round display. Lights are available upon request.



Product is packed unassembled.



Simple pop-ups, no tool assembly.



Lighting equipment is optional, not included in the original pack.



Light / UYUP367130

3x4 Printing Panel Sizes

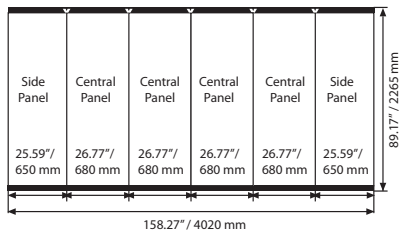

3x3 Printing Panel Sizes

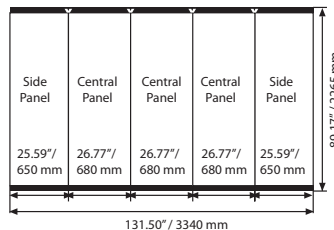

MATERIAL : Aluminium		WEIGHT	PACKING SIZE
ARTICLE	MODEL	WITH PACKING	*W X H X D
UPPC220033	Pop Up 3x3 (with Bag)	64.110 lbs	16.14" X 36.22" X 23.62"
UPPC220034	Pop Up 3x4 (with Bag)	77.823 lbs	16.14" X 36.22" X 23.62"
UPPC230033	Pop Up 3x3 (with Bag& Lighting)	67.505 lbs	16.14" X 36.22" X 23.62"
UPPC230034	Pop Up 3x4 (with Bag& Lighting)	77.823 lbs	16.14" X 36.22" X 23.62"

MATERIAL : Aluminium										WEIGHT	PACKING SIZE		
ARTICLE	MODEL	PVC PANEL				HOLDER				MAGNETIC BAR	MAGNETIC STRIPES	WITH PACKING	*W X H X D
		CENTRAL	QUANTITY	SIDE	QUANTITY	CENTRAL	QUANTITY	SIDE	QUANTITY				
UPPC200033	3 X 3	26.77" X 89.17"	3	25.59" X 89.17"	2	26.77" X 2.20" X 0.08"	6	25.59" X 2.20" X 0.03"	4	1 set 18 pcs	1181.10" (1 rulo)	48.832 lbs	16.54" X 33.86" X 16.54"
UPPC200034	3 X 4	26.77" X 89.17"	4	25.59" X 89.17"	2	26.77" X 2.20" X 0.08"	8	25.59" X 2.20" X 0.03"	4	1 set 21 pcs	1181.10" (1 rulo)	55.115 lbs	16.54" X 33.86" X 16.54"

*W:Width H: Height D: Depth



Pop-up Assembly



Slide the light properly into the spot ready on the top of the main construction. Please note that this optional item is not supplied with the pop-ups. If need be, 2 of lights come with 3x3 and 3 off lights come with 3x4.

Caution:

After the printing is applied on the black PVC panels, the brut sizes should be cut & resized to net panel sizes using at least trimming knives.

The system is suitable for 2 lights in 3x3 and 3 lights in 3x4.

This pack includes; Pop-up 3x3



1 x Pop-up Wall Magnetic.



18 x Bars with magnetic tape inside its textile bag.



1 x Roll self adhesive magnetic tape.



2 x Black PVC (Magnetic: Brut:27.17"x90.94"x0.02"
Net:25.59"x89.17"x0.02")
3 x Black PVC (Magnetic: Brut:28.74"x90.94"x0.02"
Net:26.77"x89.17"x0.02")



2 x Hanging straps with slot (25.59"x2.20"x0.03")
2 x Simple straps (27.17"x2.20"x0.03")



3 x Hanging straps with slot (26.77"x2.20"x0.08")
3 x Simple straps (26.77"x2.20"x0.08")



2 x Hanging straps with magnet (25.59"x2.20"x0.03")
2 x Simple straps (25.59"x2.20"x0.03")



2 x Hanging straps with magnet (25.59"x2.20"x0.03")
2 x Simple straps (25.59"x2.20"x0.03")



2 x Lights when it is required.

This pack includes; Pop-up 3x4



1 x Pop-up Wall Magnetic.



21 x Bars with magnetic tape inside its textile bag.



1 x Roll self adhesive magnetic tape.



2 x Black PVC (Magnetic: Brut:27.17"x90.94"x0.02"
Net:25.59"x89.17"x0.02")
4 x Black PVC (Magnetic: Brut:28.74"x90.94"x0.02"
Net:26.77"x89.17"x0.02")



2 x Hanging straps with slot (25.59"x2.20"x0.03")
2 x Simple straps (27.17"x2.20"x0.03")



4 x Hanging straps with slot (26.77"x2.20"x0.08")
4 x Simple straps (26.77"x2.20"x0.08")



2 x Hanging straps with magnet (25.59"x2.20"x0.03")
2 x Simple straps (25.59"x2.20"x0.03")



4 x Hanging straps with magnet (25.59"x2.20"x0.03")
4 x Simple straps (25.59"x2.20"x0.03")



3 x Lights when it is required.

Panset Hexagonal Counter



Panset counters are ideal products with a light & compact structure. They can be carried to different locations and re-used many times. It is easy and quick to install. Different models meet your needs in the most convenient manner. These counters are lightweight and fit quickly in the corner of a car.

After the panels are assembled, due to the fitting of panels inside the construction, the visual area is 0,5 cm smaller on all sides.

! Please first fix the shelf and then the top plate. Black textile carry bag is optional.



Max. carriage capacity
55.115lbs



Max. carriage capacity
22.046 lbs



Transport bag / UYUP074100

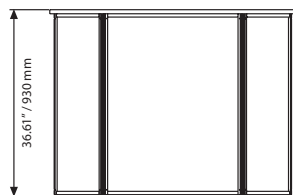
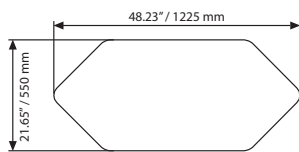

MATERIAL : Silver anodised aluminium
PANEL: Plastech PVC Foam

ARTICLE	MODEL	PANEL	QUANTITY	WEIGHT	PACKING SIZE
				WITH PACKING	*W X H X D
UPSM001000	Hexagonal	34.57" X 25.94"	1	42,549 lbs	28.35" X 50" X 5.12"
		34.57" X 12.24"	4		
UPSM007000	Wood Hexagonal	34.57" X 25.94"	1	46,958 lbs	28.35" X 50" X 5.12"
		34.57" X 12.24"	4		



*W:Width H: Height D: Depth

Panset Convex Counters



Panset counters are ideal products of light & compact structure, they can be carried to different locations and re-used many times. It is easy and fast in assembly. Different models offer you the most convenient choice for your needs. These lightweight counters fit quickly in the corner of a car.



After the panels are assembled, due to the fitting of panels inside the construction, the visual area is 0,5 cm smaller on all sides.



Please first fix the shelf and then the top plate. Black textile carry bag is optional.

Convex Counter



Max. carriage capacity 33.069 lbs

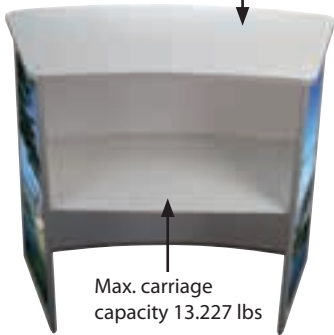

Max. carriage capacity 13.227 lbs

Wood Convex Counter



Max. carriage capacity 44.092 lbs

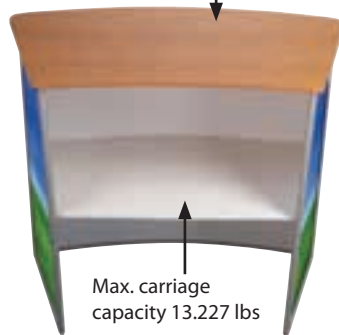

Max. carriage capacity 13.227 lbs

Midsize Convex Counter



Max. carriage capacity 33.069 lbs



Max. carriage capacity 13.227 lbs



Transport bag / UYUP074000



Transport bag / UYUP070200

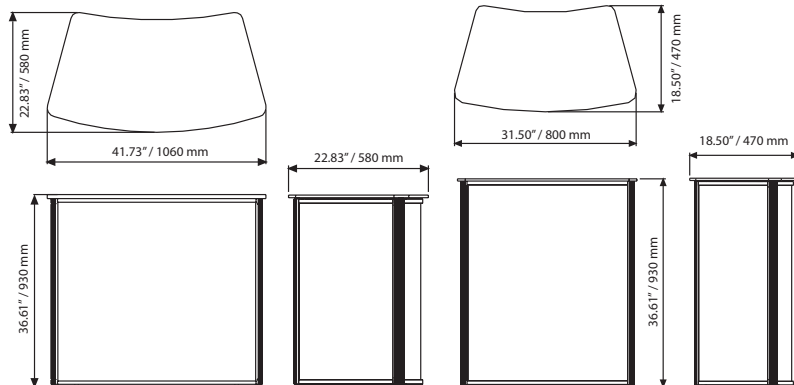

MIDSIZE COUNTER : Silver anodised aluminium PANEL: Plastech PVC Foam			WEIGHT	PACKING SIZE
ARTICLE	PANEL	QUANTITY	WITH PACKING	*W X H X D
UPSM052000	28.2" X 34.57"	1	39.903 lbs	37.40" X 46.46" X 5.51"
	13.19" X 34.57"	2		

CONVEX COUNTER : Silver anodised aluminium PANEL: Plastech PVC Foam				WEIGHT	PACKING SIZE
ARTICLE	MODEL	PANEL	QUANTITY	WITH PACKING	*W X H X D
UPSM002000	Convex	34.57" X 38.58"	1	44.312 lbs	37.40" X 46.46" X 5.51"
		34.57" X 16.93"	2		
UPSM008000	Wood Convex	34.57" X 38.58"	1	44.423 lbs	37.40" X 46.46" X 5.51"
		34.57" X 16.93"	2		



*W:Width H: Height D: Depth

Foldable Wood Counter

new



Foldable Wood Counter is compact and easy carry counter desk suitable for exhibitions, demonstrations and other kinds of presentation with 3 holders for 2x4 brochures. It is made of steel and hard MDF. Locking system ensures safe use. Heavy steel base provides stability. The counter comes ready to use with optional carry bag and folds flat for easy transportation.



The counter comes ready to use with an easy-to-understand instruction sheet.



Flat folded and flat packed.



Optional carry bag.



1 pack. See info chart for pack sizes.

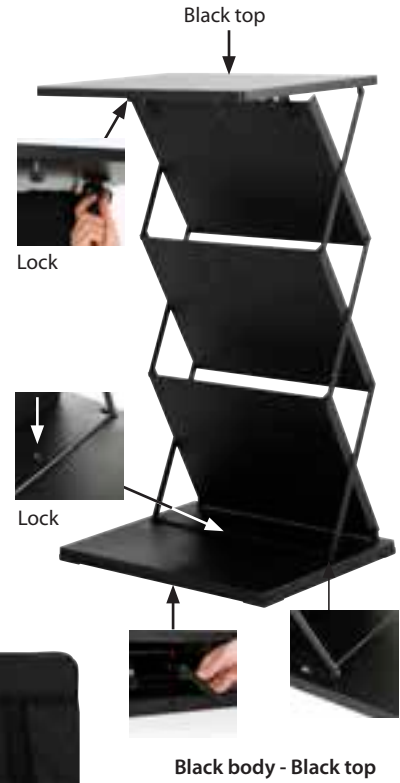

Black carry bag

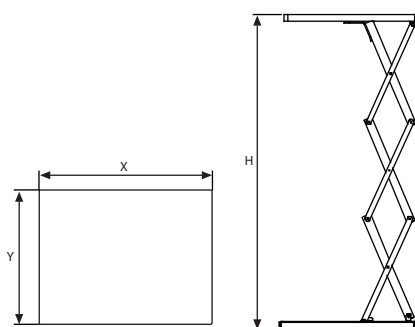

MATERIAL: Sheet metal & wood						WEIGHT	PACKING SIZE (5 Pcs)
ARTICLE	SIZE (x-y)	CAPACITY	H max.	H min.	DESCRIPTION	WITH PACKING	*W X H X D
UWFC1B0324	20.47" X 15.75"	2 X (8.5"X11")	36.42"	5.31"	Black body - Black top	2.910 lbs	8.07" X 8.07" X 6.10"
UWFC1B1324	20.47" X 15.75"	2 X (8.5"X11")	36.42"	5.31"	Black body - Black top with bag		
UWFC1D0324	20.47" X 15.75"	2 X (8.5"X11")	36.42"	5.31"	Black body - Dark wood top		
UWFC1D1324	20.47" X 15.75"	2 X (8.5"X11")	36.42"	5.31"	Black body - Dark wood top with bag		
UWFC2B0324	20.47" X 15.75"	2 X (8.5"X11")	36.42"	5.31"	Silver body - Black top		
UWFC2B1324	20.47" X 15.75"	2 X (8.5"X11")	36.42"	5.31"	Silver body - Black top with bag		
UWFC2D0324	20.47" X 15.75"	2 X (8.5"X11")	36.42"	5.31"	Silver body-Dark wood top		
UWFC2D1324	20.47" X 15.75"	2 X (8.5"X11")	36.42"	5.31"	Silver body-Dark wood top with bag		

* W:Width H: Height D: Depth



Pop-up Counter



The pop-up counter offers an easy low-budget solution that can be carried to various locations and even re-used after many events. The counter can pop up in a second with no tools required.

When we put the panel on the bag, the panel ends will overlap each other by 20 mm.

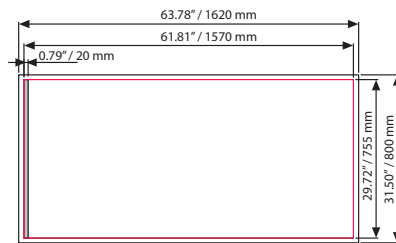
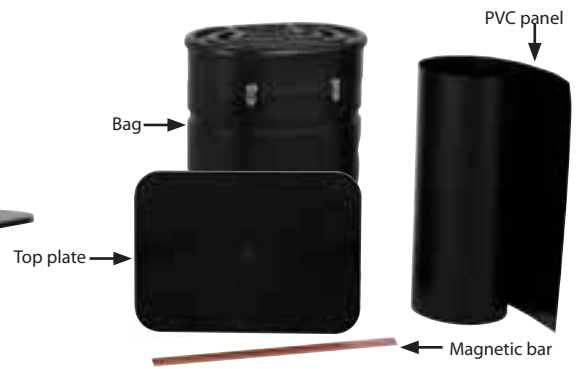

— Panel size
 — Printing area
 — Invisible area

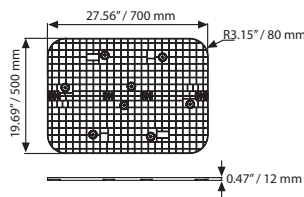
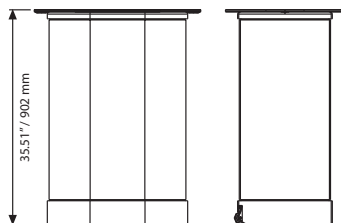

POP-UP COUNTER BAG: 0,50 mm, black PVC panel					WEIGHT	PACKING SIZE
ARTICLE	PVC PANEL	COPY SIZE	TOP PLATE	MAGNETIC BAR	WITH PACKING	*W X H X D
UPP0115020	63.78" X 31.50"	61.02" X 29.72"	27.56" X 19.69"	1 Pcs	28.682 lbs	16.54" X 36.22" X 23.62"

*W:Width H: Height D: Depth



Promostand



This simple counter is suitable for exhibitions, demonstrations and other kinds of presentation. Produced in white plastic material, ready for any kind of decoration. Foldable and easy to transport and mount. Delivered with or without carry bag. We use powder coated steel pipes to hold 0.12" thick header panel made of Plastech PVC foam.

 Product is packed unassembled with an easy-to-understand instruction sheet.

 After the front panel is assembled due to fitting of panels inside the plastic construction, the visual area is 1.50" smaller on top & bottom ends. Thickness of front panel is 0.12". Thickness of counter & shelves is 0.12".

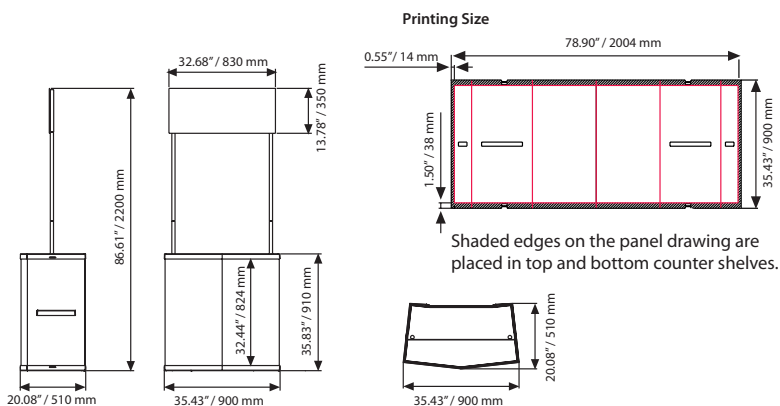
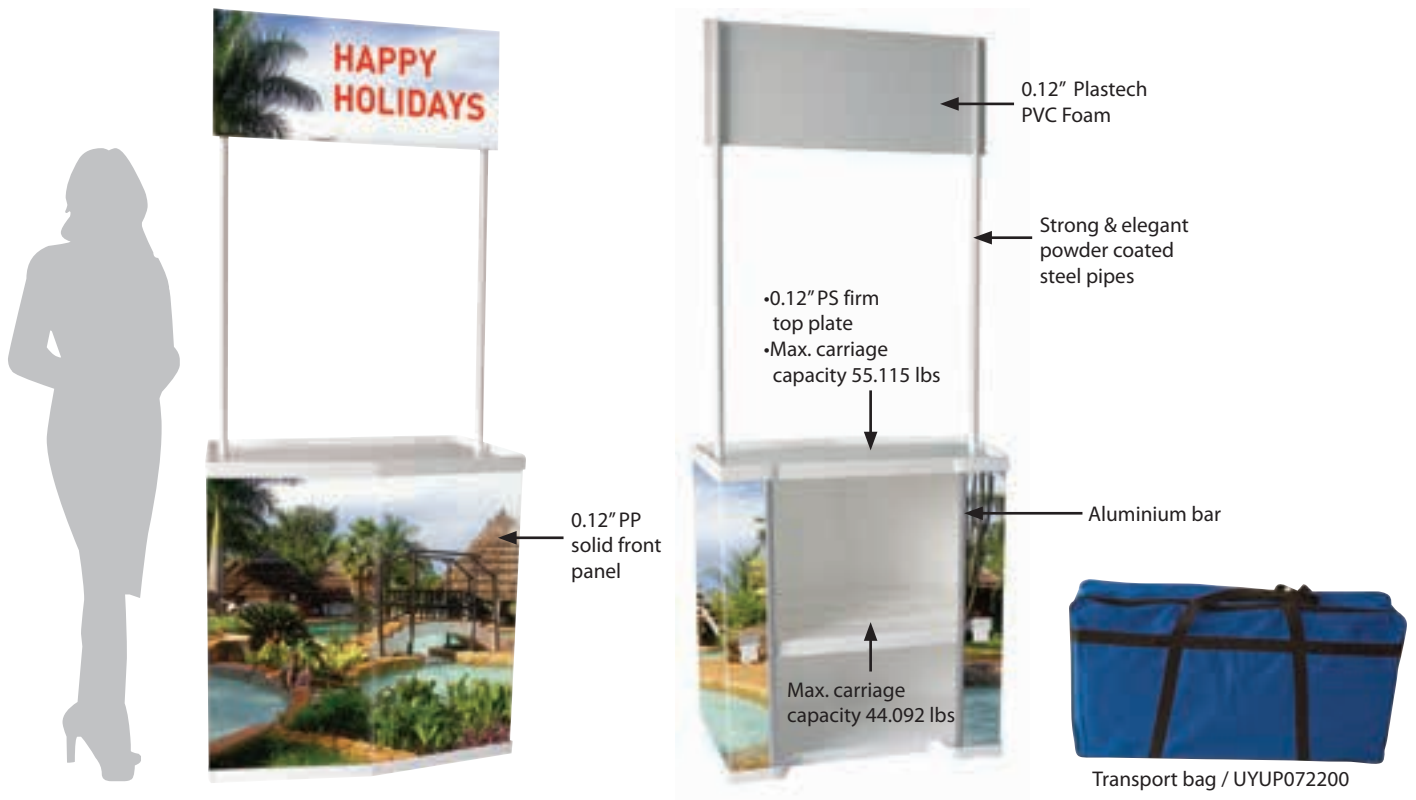

MATERIAL : Plastic				WEIGHT	PACKING SIZE
ARTICLE	DESCRIPTION	PANEL SIZE	COPY SIZE	WITH PACKING	*W X H X D
UTS00N5000	Without bag	78.90" X 35.43"	78.43" X 32.44"	29.982 lbs	21.65" X 37.40" X 6.30"
UTS00N5100	With bag	78.90" X 35.43"	78.43" X 32.44"	31,085 lbs	21.65" X 37.40" X 6.30"

*W:Width H: Height D: Depth



Petit Promostand



Petit Promostand is an outstanding counter for exhibition products demos and sample distribution. It is portable, lightweight and has white plastic material. Easy to assemble with no tools required. Front panel & top header offer space for poster printing and decoration. Designed as a foldable mobile unit, it quickly fits in the corner of a car.



Product is packed unassembled with an easy-to-understand instruction sheet.



After the front panel is assembled due to fitting of panels inside the plastic construction, the visual area is 1.50" smaller on top & bottom ends. Thickness of front panel is 0.10". Thickness of counter & shelves is 0.10". No tool assembly.

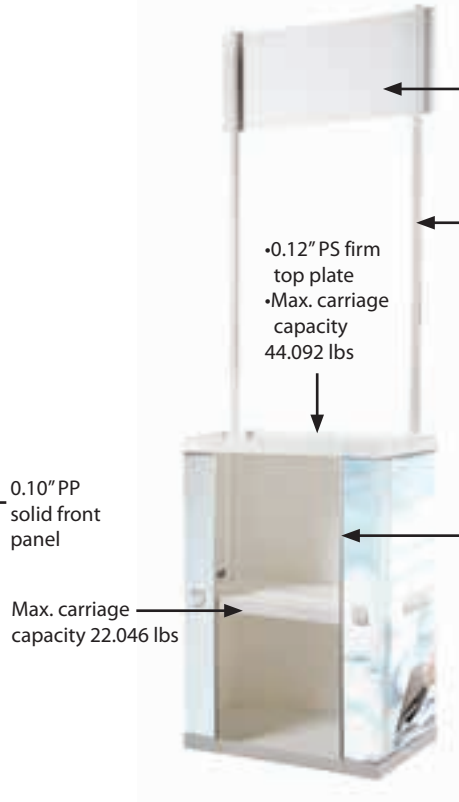

Transport bag / UYUP072300

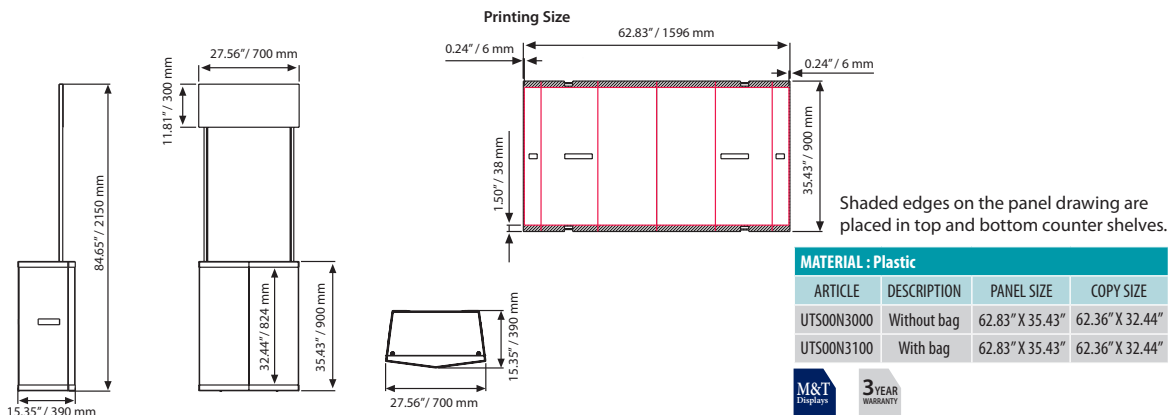

Seed Promostand



See movie at our website www.mtdisplays.com.tr



Seed Promostand is suitable for all kind of promotion events for retail promotions such as exhibitions, supermarkets, demonstrations. With its unique seed shape, it takes attention and occupies small place where it stands. Seed Promostand is a stock saving product. Ledge Seed Promostand that gives more space for item promoted. Header Seed Promostand allows for personalizing. Seed Promostand with Pole System offers choice of shelves, banners, and header. Also offered with a choice of felt fabric in grey.

Packed unassembled with an easy-to-understand instruction sheet.

Flat - pack design.

Inner shelf, header, carry bag, brochure holders excluded. See Free Standing System pages for more accessory options.

2 packs. See info chart for pack sizes.

Don't forget to order separately

- Inner shelf
- Grey felt
- Carry bag
- Header
- Ledge

•Hard white top plate.
•Max. carriage capacity 154.323 lbs

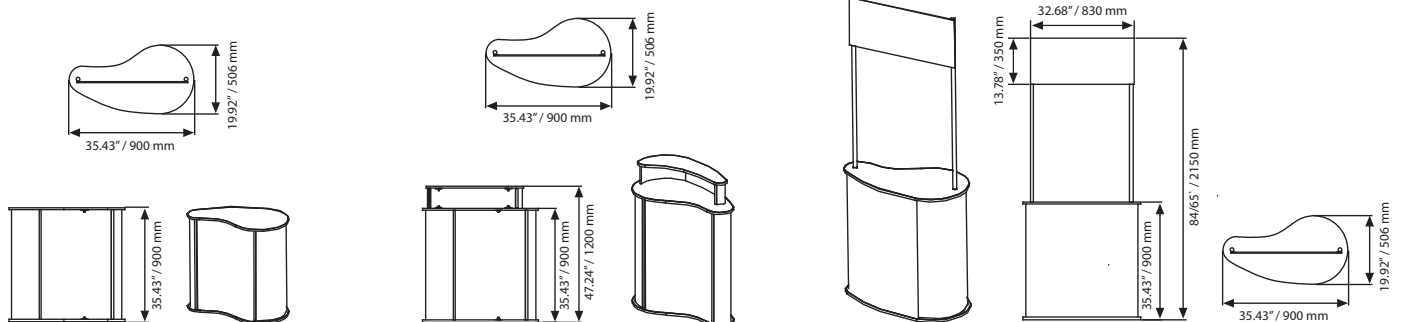
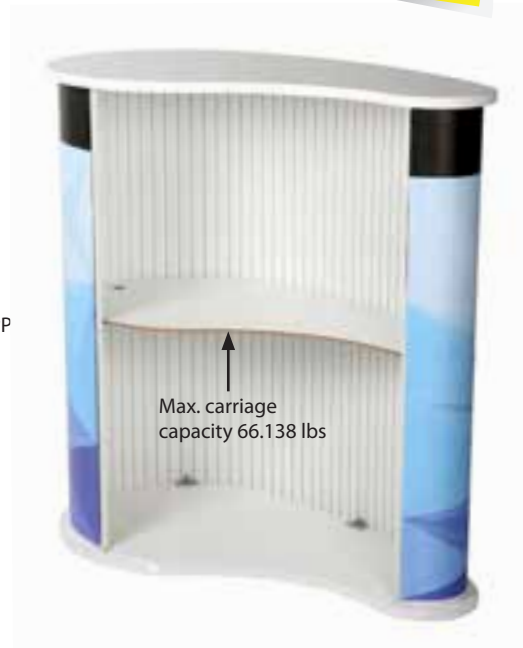



See movie at our website www.mtdisplays.com.tr

Seed Ledge Promostand

- Hard white top plate.
- Max. carriage capacity 154.323 lbs



0.39" / 10 mm
Multiwall PP.

- Hard white top plate.
- Max. carriage capacity 154.323 lbs



Max. carriage capacity 66.138 lbs



UYPOTS0030
Velcro Roll with double sided tape 59 ft.



UYPOTSC03G
Grey felt only for Seed Promostand incl. Velcro set for 35.43"



See movie at our website www.mtdisplays.com.tr

Seed Promostand with Header



0.12" / 3 mm
PVC Foam.

Don't forget to order separately

- Inner shelf
- Grey felt
- Carry bag
- Header
- Ledge

- Hard white top plate.
- Max. carriage capacity 154.323 lbs.



UYPOTS1050
Carry bag

Strong & elegant powder coated steel pipes.



Max. carriage capacity 66.138 lbs.

MATERIAL : Plastic				WEIGHT	PACKING SIZE
ARTICLE	DESCRIPTION	PANEL SIZE	PRINTING SIZE	WITH PACKING	*W X H X D
UTSC00909	w/out bag,w/out felt,w/out shelf	60.24" X 35.12"	58.90" X 34.06"	18.077 lbs	21.06" X 37.01" X 2.76" / 7.87" X 37.01" X 7.87"
UTSC020909	with header,w/out bag,w/out felt,w/out shelf	60.24" X 35.12"	58.90" X 34.06"	24.250 lbs	21.06" X 37.01" X 3.74" / 7.87" X 48.82" X 7.87"
UTSC010912	Ledge w/out bag,w/out felt,w/out shelf	60.24" X 35.12"	58.90" X 34.06"	20.943 lbs	22.44" X 40.94" X 3.74" / 7.87" X 37.01" X 7.87"
UYPOTSC010	Inner shelf only,white	33.46" X 17.48"		2.204 lbs	33.66" X 17.68" X 0.28"
UYPOTSC020	Inner shelf only for header ,white	33.46" X 17.48"		2.204 lbs	33.66" X 17.68" X 0.28"
UYPOTSC03G	Grey felt only incl.Velcro.	61.42" X 34.06"	61.42" X 34.06"	0.749 lbs	9.84" X 9.84" X 3.94"
UTSC030909	Pole system,w/out bag or felt or shelf or header	61.30" X 35.12"	59.96" X 34.06"	23.809 lbs	21.06" X 37.01" X 2.76" / 8.07" X 51.97" X 5.71"
UYPOTSC040	Header only for pole system	13.78" X 19.69"	13.78" X 19.69"	1.102 lbs	12.60" X 20.08" X 1.18"
UYPOTSP010	Inner shelf only for pole system,White	34.37" X 17.48"		2.535 lbs	34.57" X 17.68" X 0.28"
UYPOTSP03G	Grey felt only for pole system incl.Velcro	62.32" X 34.06"	62.32" X 34.06"	0.771 lbs	9.84" X 9.84" X 3.94"

*W:Width H: Height D: Depth



Variations & Seed Promostand with Pole System



See movie at our website www.mtdisplays.com.tr

Make up your stand to fit your own wishes!



Mix and match your own stand!

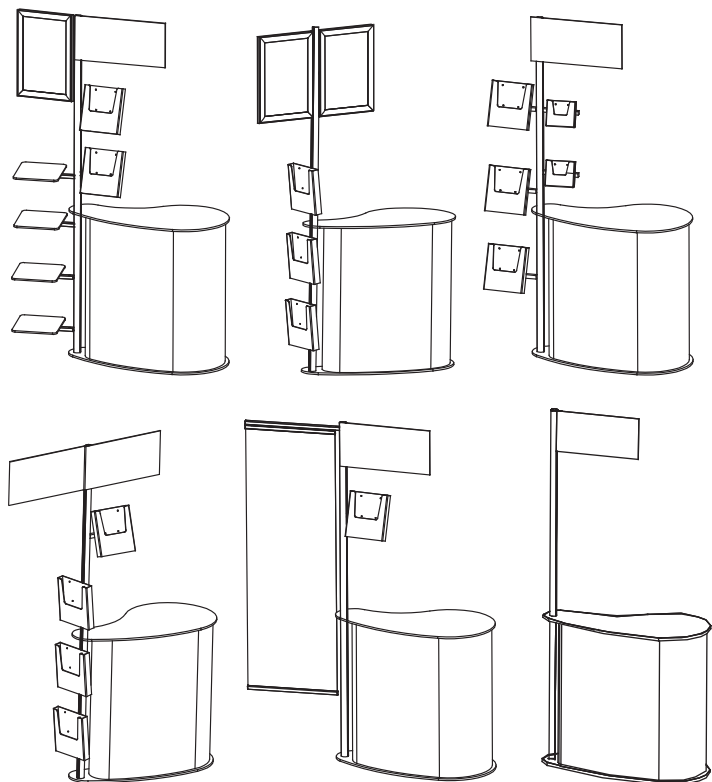

Don't forget to order separately

- Inner shelf
- Grey felt
- Carry bag
- Header
- Ladder
- Circle & square shelves
- Leaflet holders
- Slide-in frames
- Banner holder

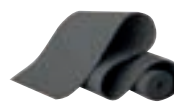

Acrylic Shelf 8.5"x11" Size
UFSL140000

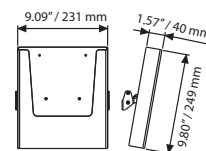

MDF Shelf Circle
UFSL002500

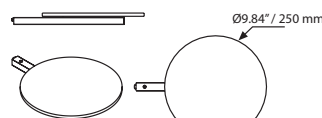

MDF Shelf Square
UFSL002510

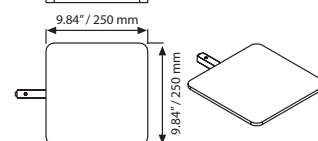

Rectangular Promostand





See movie at our website www.mtdisplays.com.tr



This simple counter is suitable for all kind of promotion events for retail promotions such as exhibitions, supermarkets, demonstrations. Rectangular Promostand is a stock saving product. Ledge Rectangular Promostand that gives more space for item promoted. Header Rectangular Promostand allows for personalizing and helps the brand and promotion to be seen from a distance. Also offered with a choice of felt fabric in grey.

 Packed unassembled with an easy-to-understand instruction sheet.

 Flat - pack design.

 Inner shelf, header, carry bag, brochure holders excluded. See Free Standing System pages for more accessory options.

 2 packs. See info chart for pack sizes.



0.39" / 10 mm
Multiwall PP.

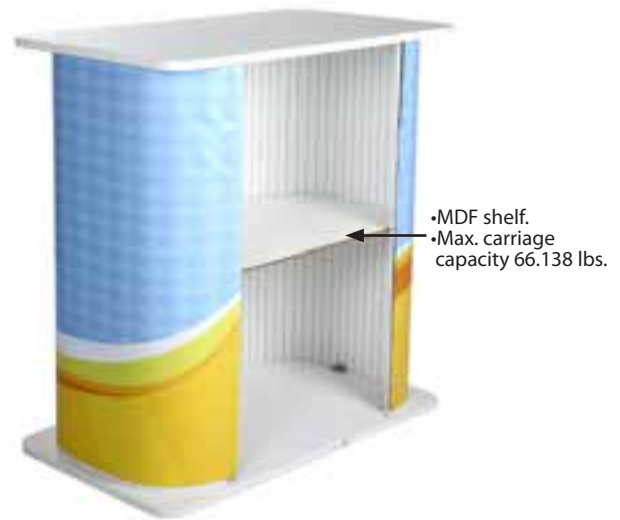

Don't forget to order separately

- Inner shelf
- Grey felt
- Carry bag
- Header
- Ledge

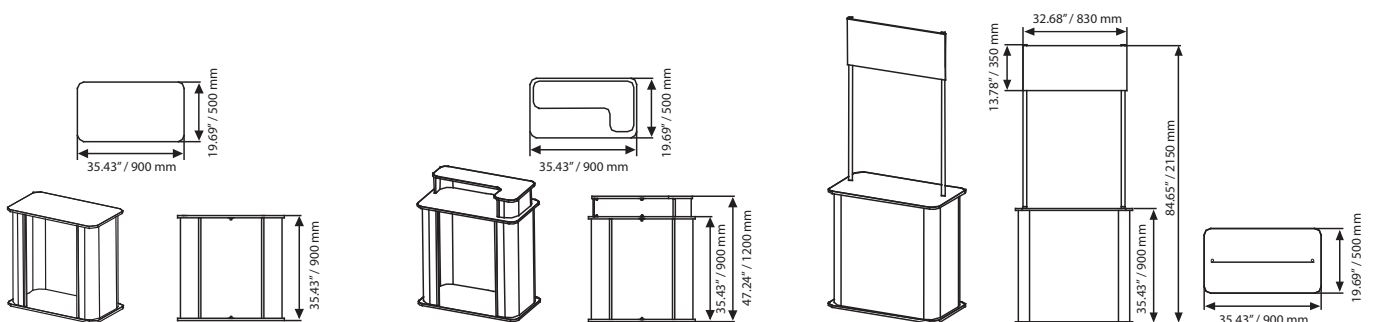



See movie at our website www.mtdisplays.com.tr

Rectangular Ledge Promostand



0.39" / 10 mm
Multiwall PP.

•Hard white top plate.
•Max. carriage
capacity 154.323 lbs.

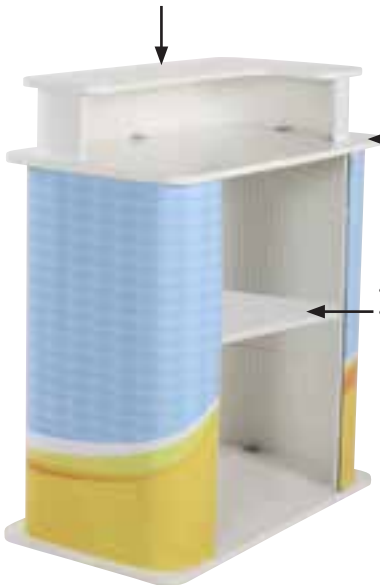

•Hard white top
plate.
•Max. carriage
capacity
154.323 lbs.

•MDF shelf.
•Max. carriage
capacity
66.138 lbs.



See movie at our website www.mtdisplays.com.tr

Rectangular Promostand with Header

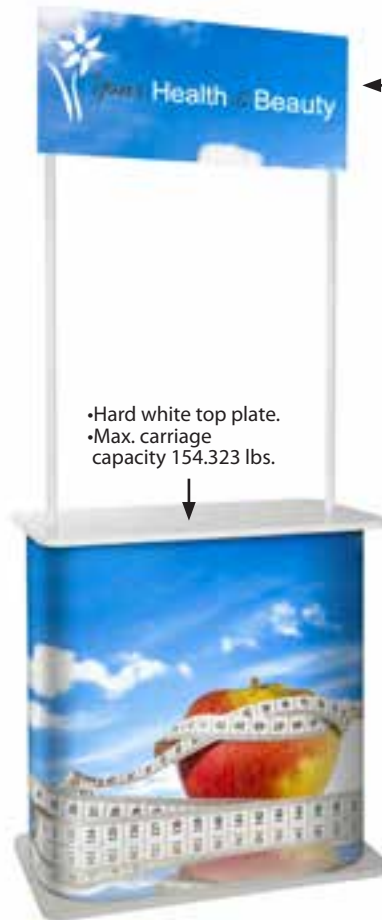

0.12" / 3 mm
PVC Foam.

•Hard white top plate.
•Max. carriage
capacity 154.323 lbs.

Don't forget to order
separately
• Inner shelf
• Grey felt
• Carry bag
• Header
• Ledge

Strong &
elegant powder
coated steel
pipes.



0.39" / 10 mm
Multiwall PP.



UYPOTS1050
Carry bag



UYPOTS0030
Velcro Roll with double
sided tape 59 ft.



UYPOTSD03G
Grey felt only for Rectangular
Promostand incl.
Velcro set for 35.43".

MATERIAL : Plastic				WEIGHT	PACKING SIZE
ARTICLE	DESCRIPTION	PANEL SIZE	PRINTING SIZE	WITH PACKING	*W X H X D
UTSD000909	w/out bag,w/out felt,w/out shelf	72.80" X 35.12"	71.46" X 34.06"	25.353 lbs	21.06" X 37.01" X 2.76" / 7.87" X 37.01" X 7.87"
UTSD020909	with header,w/out bag,w/out felt,w/out shelf	72.80" X 35.12"	71.46" X 34.06"	31.526 lbs	21.06" X 37.01" X 3.74" / 7.87" X 48.82" X 7.87"
UTSD010912	Ledge w/out bag,w/out felt,w/out shelf	72.80" X 35.12"	71.46" X 34.06"	31.967 lbs	22.44" X 40.94" X 3.74" / 7.87" X 37.01" X 7.87"
UYPOTSD010	Inner shelf only,white	33.46" X 17.72"		3.858 lbs	33.66" X 17.68" X 0.28"
UYPOTSD020	Inner shelf only for header ,white	33.46" X 17.72"		3.858 lbs	33.66" X 17.68" X 0.28"
UYPOTSD03G	Grey felt only incl.Velcro.	73.62" X 34.06"	73.62" X 34.06"	0.793 lbs	9.84" X 9.84" X 3.94"

* W:Width H: Height D: Depth



Circle Promostand



See movie at our website www.mtdisplays.com.tr



This round counter is suitable for all kind of promotion events for retail promotions such as exhibitions, supermarkets, demonstrations. Round shape takes attention and gives more space for visitors to examine items presented. Circle Promostand is a stock saving product. Keeping components available in stock as flat-pack, it enables to offer numerous of variations. Ledge Circle Promostand that gives more space for item promoted. Header Circle Promostand allows for personalizing and helps the brand and promotion to be seen from a distance. Also offered with a choice of felt fabric in grey.

Packed unassembled with an easy-to understand instruction sheet.

Flat - pack design.

Inner shelf, header, carry bag, brochure holders excluded. See Free Standing System pages for more accessory options.

2 packs. See info chart for pack sizes.



Don't forget to order separately

- Inner shelf
- Grey felt
- Carry bag
- Header
- Ledge

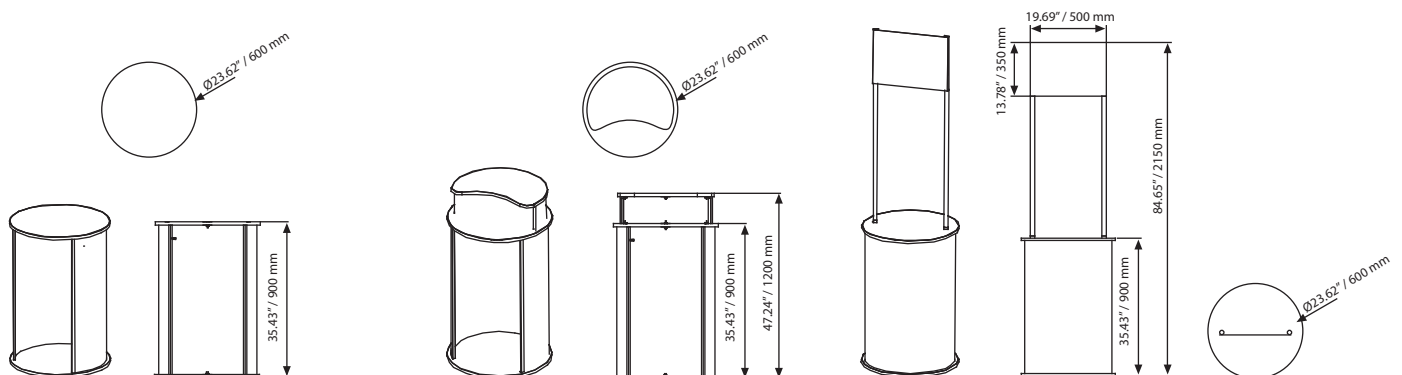



See movie at our website www.mtdisplays.com.tr

Circle Ledge Promostand



- Hard white top plate.
- Max. carriage capacity 154.323 lbs.



See movie at our website www.mtdisplays.com.tr

Circle Promostand with Header

Don't forget to order separately

- Inner shelf
- Grey felt
- Carry bag
- Header
- Ledge



0.12" / 3 mm PVC Foam.

Strong & elegant powder coated steel pipes



- Hard white top plate.
- Max. carriage capacity 154.323 lbs.

0.39" / 10 mm Multiwall PP.

- MDF shelf.
- Max. carriage capacity 66.138 lbs.

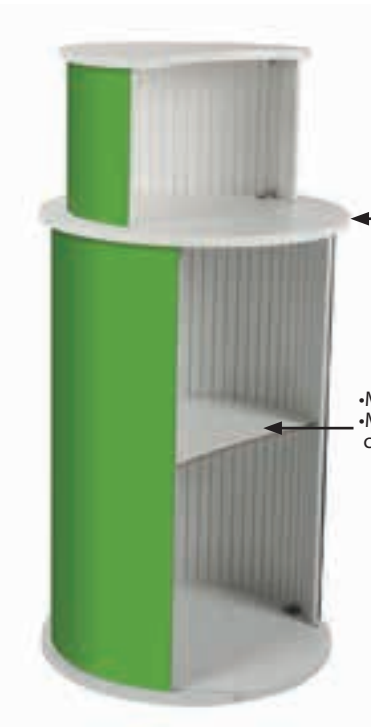

- Hard white top plate.
- Max. carriage capacity 154.323 lbs.

- MDF shelf.
- Max. carriage capacity 66.138 lbs.



UYPOTS3050 Carry bag



UYPOTS0030 Velcro Roll with double sided tape 59 ft.



UYPOTSR03G Grey felt only for Circle Promostand incl. Velcro set for 35.43"

MATERIAL : Plastic				WEIGHT	PACKING SIZE
ARTICLE	DESCRIPTION	PANEL SIZE	PRINTING SIZE	WITH PACKING	*W X H X D
UTSR000609	w/out bag,w/out felt,w/out shelf	48.74" X 35.12"	47.40" X 34.06"	16.534 lbs	24.80" X 24.80" X 2.76" / 7.87" X 37.01" X 7.87"
UTSR020609	with header,w/out bag,w/out felt,w/out shelf	48.74" X 35.12"	47.40" X 34.06"	22.487 lbs	24.80" X 24.80" X 3.74" / 7.87" X 40.94" X 7.87"
UTSR010612	Ledge w/out bag,w/out felt,w/out shelf	48.74" X 35.12"	47.40" X 34.06"	21.384 lbs	24.80" X 24.80" X 3.74" / 7.87" X 48.82" X 7.87"
UYPOTSR010	Inner shelf only,white	21.65" X 16.34"		1.984 lbs	21.85" X 16.54" X 0.28"
UYPOTSR020	Inner shelf only for header ,white	21.65" X 16.34"		1.984 lbs	21.85" X 16.54" X 0.28"
UYPOTSR03G	Grey felt only incl.Velcro.	49.33" X 34.06"	49.33" X 34.06"	0.683 lbs	9.84" X 9.84" X 3.94"

* W:Width H: Height D: Depth



Bean Promostand



See movie at our website www.mtdisplays.com.tr



This contemporary counter is suitable for all kind of promotion events for retail promotions such as exhibitions, supermarkets, demonstrations. Bean Promostand is a stock saving product. Keeping components available in stock as flat-pack, it enables to offer numerous of variations. Ladder Bean Promostand that gives more space for item promoted. Header Bean Promostand allows for personalizing. Also offered with a choice of felt fabric in grey.

Packed unassembled with an easy-to-understand instruction sheet.

Flat - pack design.

Inner shelf, header, carry bag, brochure holders excluded. See Free Standing System pages for more accessory options.

2 packs. See info chart for pack sizes.

Don't forget to order separately

- Inner shelf
- Grey felt
- Carry bag
- Header
- Ledge

•Hard white top plate.
•Max. carriage capacity 154.323 lbs.



← 0.39" / 10 mm
Multiwall PP.



•MDF shelf.
•Max. carriage capacity 66.138 lbs.

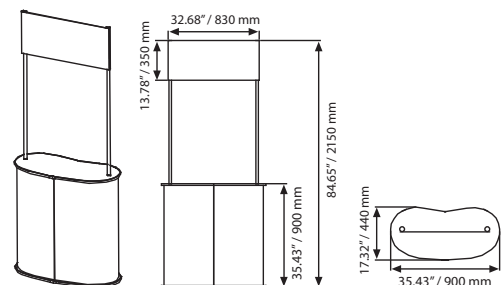
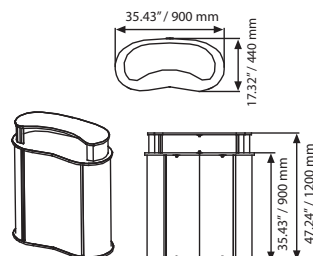
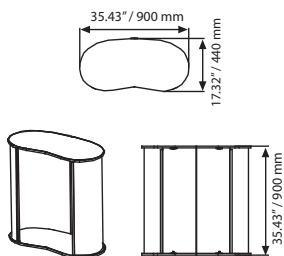



See movie at our website www.mtdisplays.com.tr

Bean Ledge Promostand



0.39" / 10 mm
Multiwall PP.

•Hard white top plate.
•Max. carriage
capacity 154.323 lbs.



•Hard white top plate.
•Max. carriage
capacity 154.323 lbs.

•MDF shelf.
•Max. carriage
capacity 66.138 lbs.

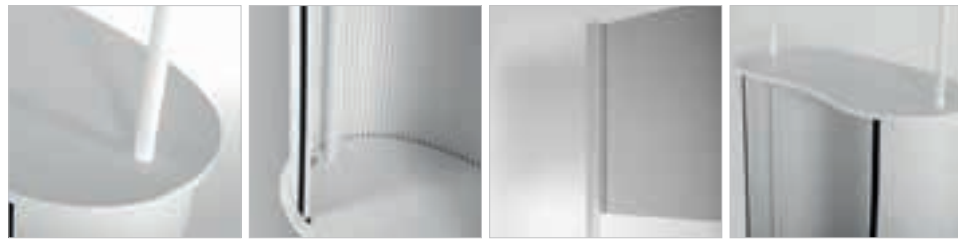

See movie at our website www.mtdisplays.com.tr

Bean Promostand with Header

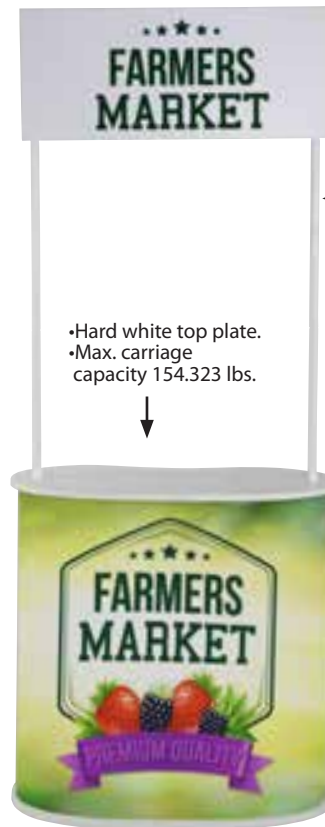

•Hard white top plate.
•Max. carriage
capacity 154.323 lbs.

Strong & elegant
powder coated
steel pipes

0.12" / 3 mm
PVC Foam.



•MDF shelf.
•Max. carriage
capacity
66.138 lbs.

0.39" / 10 mm
Multiwall PP.

Don't forget to order
separately
• Inner shelf
• Grey felt
• Carry bag
• Header
• Ledge



UYPOTS1050
Carry bag



UYPOTS0030
Velcro Roll with double
sided tape 59 ft.

UYPOTSB03G
Grey felt only for Bean
Promostand incl. Velcro
set for 35.43".

MATERIAL : Plastic				WEIGHT	PACKING SIZE
ARTICLE	DESCRIPTION	PANEL SIZE	PRINTING SIZE	WITH PACKING	*W X H X D
UTSB000909	w/out bag,w/out felt,w/out shelf	61.30" X 35.12"	59.96" X 34.06"	20.943 lbs	18.50" X 18.50" X 2.76" / 7.87" X 37.01" X 7.87"
UTSB020909	with header,w/out bag,w/out felt,w/out shelf	61.30" X 35.12"	59.96" X 34.06"	26.896 lbs	18.50" X 37.01" X 3.74" / 7.87" X 48.82" X 7.87"
UTSB010912	Ledge w/out bag,w/out felt,w/out shelf	61.30" X 35.12"	59.96" X 34.06"	27.116 lbs	510 X 1040 X 3.74" / 7.87" X 37.01" X 7.87"
UYPOTSB010	Inner shelf only,white	33.66" X 14.57"		2.645 lbs	33.86" X 15.20" X 0.28"
UYPOTSB020	Inner shelf only for header ,white	33.66" X 14.57"		2.645 lbs	33.86" X 15.20" X 0.28"
UYPOTSB03G	Grey felt only incl.Velcro.	62.01" X 34.06"	62.01" X 34.06"	0.749 lbs	9.84" X 9.84" X 3.94"

* W:Width H: Height D: Depth



Tumble Box

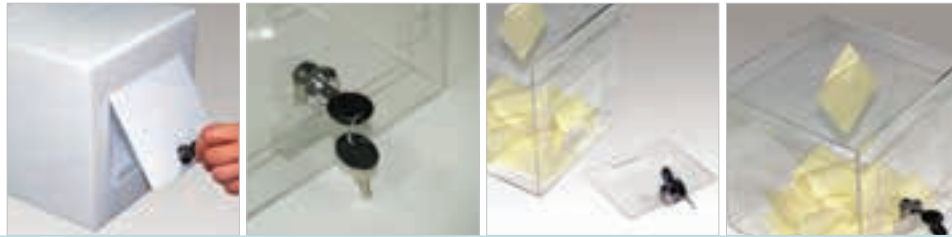

The clear acrylic Tumble Box makes voting transparent, by granting the people insight into the box. Also this box helps to collect the demands, suggestions or complaints of workers in companies, restaurants or offices. Serves the collection of different tickets. Fits perfect in a counter with limited space. Accepts printing on surrounding walls. There is a lock system at its top keeping the documents safe inside at the front side of the cube.

 Each box includes 1 key set of single variation.

 Please handle with care during transportation.



Clear

Opaque

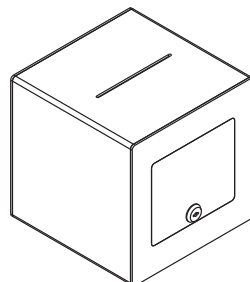
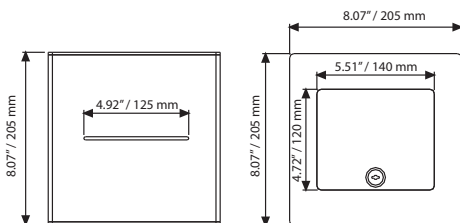

MATERIAL : Acrylic		WEIGHT	PACKING SIZE
ARTICLE	DESCRIPTION	WITH PACKING	*W X H X D
UTBCOS0000	Clear	2.821 lbs	9.45" X 9.84" X 9.45"
UTBCOW0000	Opaque	2.821 lbs	9.45" X 9.84" X 9.45"

* W:Width H: Height D: Depth



Puzzle Tumble Box



See movie at our website www.mtdisplays.com.tr

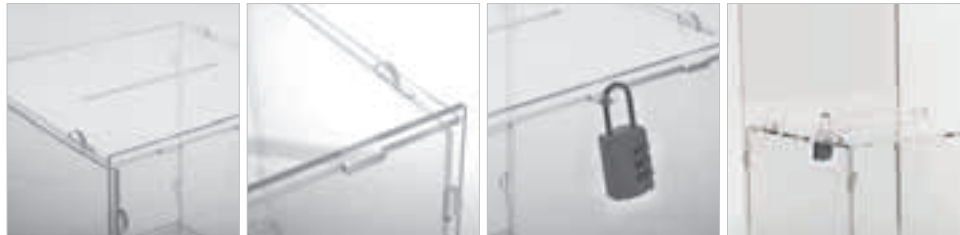

Locking Puzzle Box is suitable for different environments. Easy to assemble with help of mounting sheet provided. Key and padlock securely protect the box content. Flat pack saves from space. This suggestion box is perfect for high traffic areas. Available in 2 sizes.



Please handle with care during transportation. Please peel of the film over the product before use.



Available with header and without header. Available in Opaque and Transparent finishes.

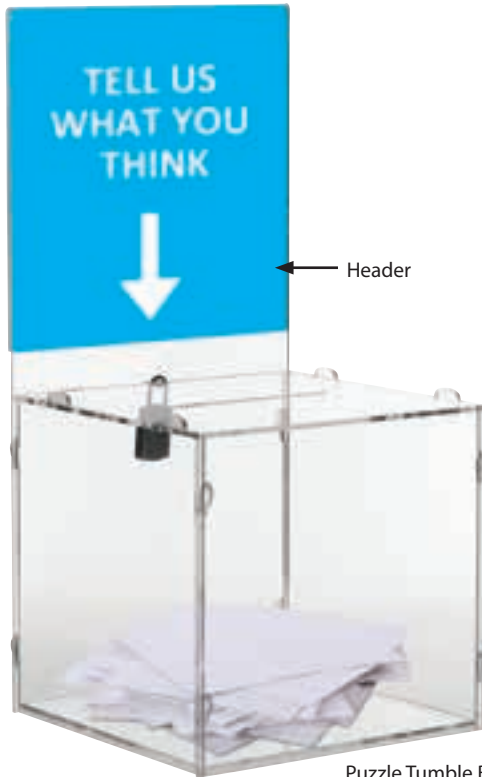

Puzzle Tumble Box with Header

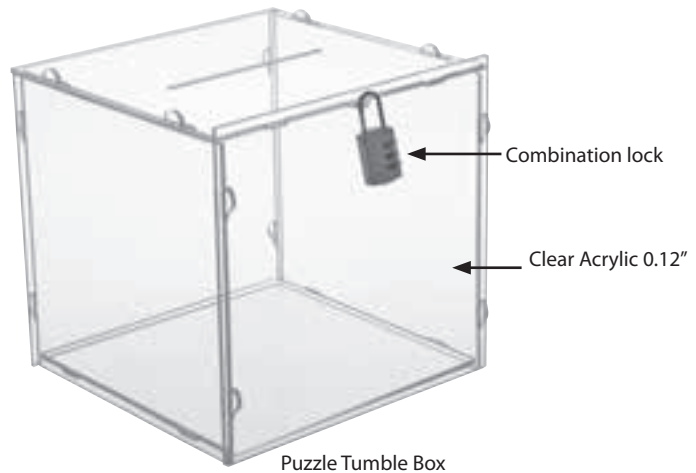

Puzzle Tumble Box



Flat pack

Puzzle Tumble Box

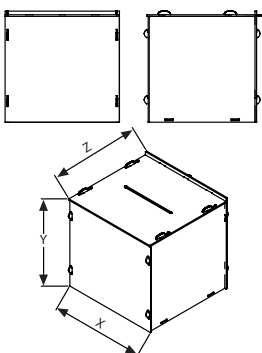

Puzzle Tumble Box with Header

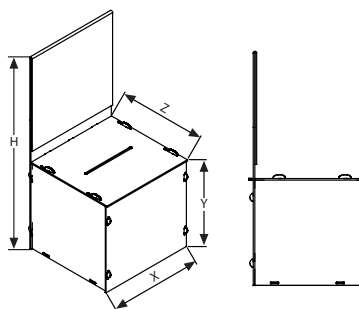

MATERIAL : Clear acrylic 3 mm					WEIGHT	PACKING SIZE
ARTICLE	SIZE	EXTERNAL (x-y-z)	H	DESCRIPTION	WITH PACKING	*W X H X D
UTBP0S0085	8.5" X 11"	8.50" X 8.27" X 8.50"	-	Clear	3.306 lbs	9.84" X 20.08" X 0.83"
UTBP0S0012	12" X 12"	12.01" X 11.77" X 12.01"	-	Clear	5.180 lbs	13.78" X 26.77" X 0.83"
UTBP0S1085	8.5" X 11"	8.50" X 8.27" X 8.50"	17.52"	Clear with header	4.122 lbs	9.84" X 20.08" X 0.83"
UTBP0S1012	12" X 12"	12.01" X 11.77" X 12.01"	24.80"	Clear with header	6.922 lbs	13.78" X 26.77" X 0.83"

* W:Width H: Height D: Depth



Free Standing Puzzle Tumble Box



See movie at our website www.mtdisplays.com.tr



Locking Floor Standing Puzzle Box is suitable for different environment where the space is very tight. Easy to assemble with help of mounting sheet provided. Key and padlock securely protect the box content. Flat pack saves from space. This suggestion box is perfect for high traffic areas and suitable for tradeshows and fundraising even as well. Available in 2 sizes. It has a sturdy metal base which provide stability.

Please handle with care during transportation. Please peel of the film over the product before use.

Available with header and without header. Available in Opaque and Transparent finishes.

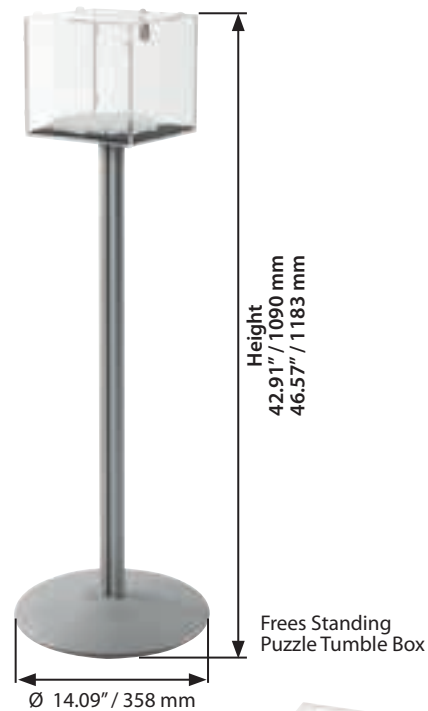
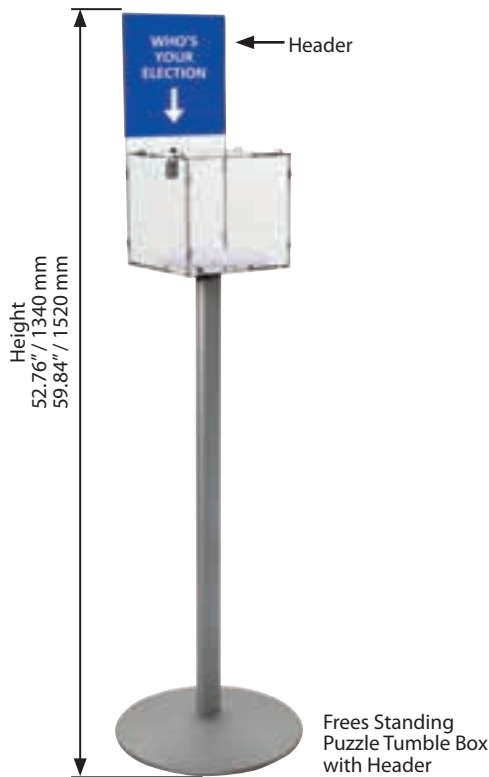

Frees Standing Puzzle Tumble Box

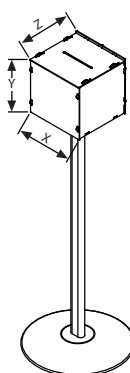

Weight of base is 1.763 lbs.

Frees Standing Puzzle Tumble Box with Header

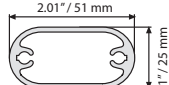
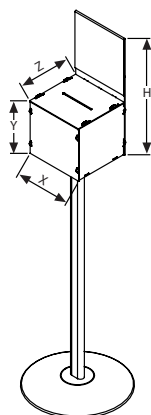

MATERIAL : Clear acrylic 3 mm				WEIGHT	PACKING SIZE
ARTICLE	SIZE	EXTERNAL (x-y-z)	H	WITH PACKING	*W X H X D
UTBP1S0085	8.5" X 11"	8.50" X 8.27" X 8.50"	-	13.580 lbs	16.93" X 36.22" X 2.76"
UTBP1S0012	12" X 12"	12.01" X 11.77" X 12.01"	-	16.534 lbs	16.93" X 44.09" X 2.76"
UTBP1S1085	8.5" X 11"	8.50" X 8.27" X 8.50"	17.52"	14.021 lbs	16.93" X 36.22" X 2.76"
UTBP1S1012	12" X 12"	12.01" X 11.77" X 12.01"	24.80"	16.534 lbs	16.93" X 44.09" X 2.76"

*W:Width H:Height D:Depth





Office Products

- Door Signs
- Desktop Sign
- Wall Sign System
- Wall Sign Double Sided
- Sign Systems
 - Toilet Logo Systems Chrome
 - Decorative Toilet Signs
 - Aluminum Panel Braille Signs
 - ABS Plastic Braille Signs
 - Plastic Chromed House Numbers
- Clip Board
- Fast Note
- Magnetic Glass Board
- Business Card Holder
- Coat Racks
 - Spring Coat Rack
 - Pine Coat Rack
 - Sunflower Coat Rack
 - Fountain Coat Rack
 - Ladder Coat Rack
 - Coat Hanger Stand
 - Maze Coat Rack
 - Trio Coat Rack
- Waste Baskets
 - Flat Pedal Trash Can
 - Hotel Trash Can
 - Flat Pedal Trash Can Inner Bucket
 - Stainless Steel Push Can Dust Bin
 - Single Wall Stainless Steel Waste Basket
 - Double Wall Stainless Steel Waste Basket
 - Angled Top Stainless Steel Stand-up Ashtray
 - Stainless Steel Stand-up Ashtray
- 2 Step Plastic Stepstool **NEW**



Door Signs

0.59" - 1.02"



See movie at our website www.mtdisplays.com.tr



Suitable for use in open-air spaces or public areas such as schools, offices, hospitals, etc.. It is an elegant and practical product. You merely need to open the front profile in order to change your documents. An anti-reflex PET cover protects your documents from tearing and suffering damage. It can be used both in portrait and landscape positions.

Each door sign includes adhesive tape & mounting instruction sheet.

0.59" in top snap 0.31" poster & in bottom snap 0.31" poster is placed within the clamping system. 1.02" in top snap 0.43" poster & in bottom snap 0.43" poster is placed within the clamping system. Please clean the surface before applying the double-sided tape for better application.



0.59" / 15 mm



1.02" / 26 mm

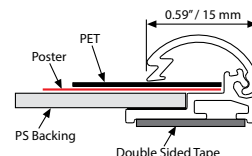
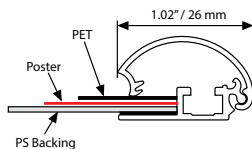
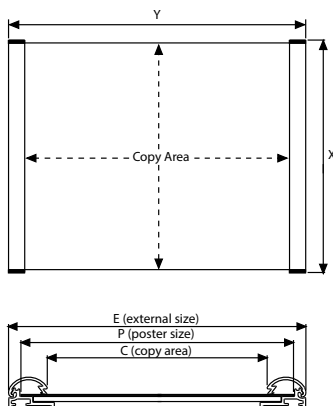

0.59" / 15 mm : Silver anodised aluminium Poster Snap				WEIGHT	PACKING SIZE
ARTICLE	EXTERNAL (x-y)	POSTER	COPY	WITH PACKING	*W X H X D
UDS150N046	4.20" X 6.39"	4" X 6"	4" X 5.17"	1.333 lbs	4.72" X 7.87" X 3.94" (5 Pcs)
UDS150N057	5.20" X 7.39"	5" X 7"	5" X 6.17"	1.984 lbs	7.09" X 9.45" X 5.51" (5 Pcs)
UDS150N081	8.70" X 11.39"	8.5" X 11"	8.5" X 10.17"	5.577 lbs	9.65" X 13.78" X 3.15" (10 Pcs)
1.02" / 26 mm : Silver anodised aluminium Poster Snap				WEIGHT	PACKING SIZE
ARTICLE	EXTERNAL (x-y)	POSTER	COPY	WITH PACKING	*W X H X D
UDS0008000	4.24" X 7.14"	4" X 6"	4" X 5.13"	1.102 lbs	4.72" X 7.87" X 3.94" (10 pcs)
UDS0007000	5.24" X 8.14"	5" X 7"	5" X 6.13"	1.984 lbs	5.31" X 7.87" X 3.94" (5 pcs)
UDS0006000	8.74" X 12.14"	8.5" X 11"	8.5" X 10.13"	2.976 lbs	10.04" X 13.39" X 3.15" (5 pcs)

* W:Width H:Height D:Depth





Desktop Signs



Offering a complete range, aluminium wall sign profiles are design to enable usage on a counter to match Wall Signs. Desktop Sign is fixed to a convenient reading angle to be seen by the customers easily. It is suitable for receptions, restaurants, cafés and many more. It is a practical product to change the message very often.

 Use the suction cup enclosed to easily remove the insert.

 Compatible signage methods; printed papers from common printers, cut vinyl, digitally printed vinyl, screen-printed materials.

 Suitable for paper, plastic or any flexible material up to 0.04" thick.

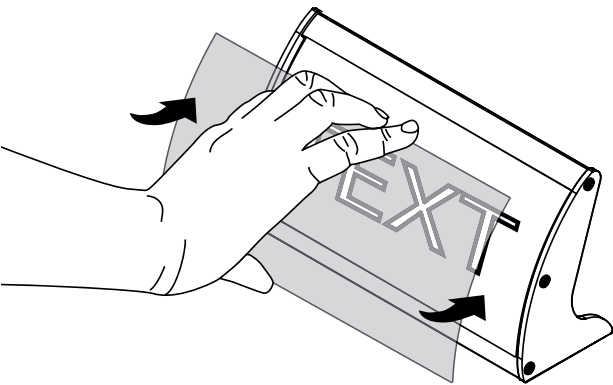

Suction Cup / UYAA006010

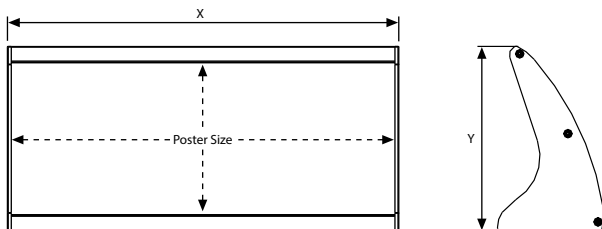

DESKTOP SIGN: Silver anodised aluminium			WEIGHT	PACKING SIZE
ARTICLE	EXTERNAL (x-y)	POSTER SIZE	WITH PACKING	*W X H X D
UMDS740N15	6.10" X 3.23"	2.91" X 5.91"	0.440 lbs	4.33" X 7.09" X 2.95"
UMDS740N20	8.07" X 3.23"	2.91" X 7.87"	0.551 lbs	4.33" X 9.06" X 2.95"
UMDS740N25	10.04" X 3.23"	2.91" X 9.84"	0.771 lbs	4.33" X 11.02" X 2.95"
UMDS105N15	6.10" X 4.33"	4.13" X 5.91"	0.551 lbs	5.51" X 6.69" X 3.35"
UMDS105N20	8.07" X 4.33"	4.13" X 7.87"	0.771 lbs	5.51" X 9.06" X 3.35"
UMDS105N25	10.04" X 4.33"	4.13" X 9.84"	0.881 lbs	5.51" X 11.02" X 3.35"
UMDS105N30	12.01" X 4.33"	4.13" X 11.81"	0.992 lbs	5.51" X 12.99" X 3.35"
UMDS148N20	8.07" X 5.83"	5.83" X 7.87"	0.881 lbs	7.09" X 9.06" X 3.74"
UMDS148N25	8.07" X 5.83"	5.83" X 9.84"	0.992 lbs	7.09" X 11.02" X 3.74"
UMDS148N30	12.01" X 5.83"	5.83" X 11.81"	1.102 lbs	7.09" X 12.60" X 3.74"

*W:Width H: Height D: Depth



Wall Sign System



See movie at our website www.mtdisplays.com.tr



Fast and simple!

The Wall Sign system is a perfect solution for wall posters and signs. It allows clear visibility for the poster and has an aesthetic curved shape. The stylish curved Wall Sign system in various sizes suits the room sign and way finding needs within the building. Designed for paper inserts and is offered in variety of profile types to match different projects. The front cover is anti-reflex which is flexed into place after inserting the paper. Poster inserts can be created from common inkjet or laser printers. Printed-paper inserts may be in portrait or landscape outline and various sizes fitting in 4 profile types.

Each sign includes double sided tape, one suction cup and mounting instruction sheet.

Use the suction cup to easily remove the inserts from the signs by simply attaching it to the inserts and pulling.

Compatible signage methods; printed papers from common printers, cut vinyl, digitally printed vinyl, screen-printing. Please clean the surface before applying the double-sided tape for better application.



5.83" x 11.81" / 148 x 300 mm



4.13" x 9.84" / 105 x 250 mm



2.91" x 5.91" / 74 x 150 mm



2.05" x 5.91" / 52 x 150 mm



Flat cap



Arc cap



Poster
Clear cover
Arc cap



Double sided tape



Suction cup



Model 2.05" / 52 mm

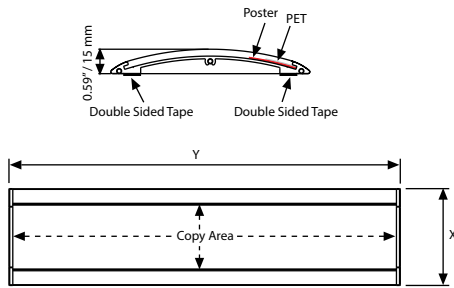

Model 2.91" / 74 mm

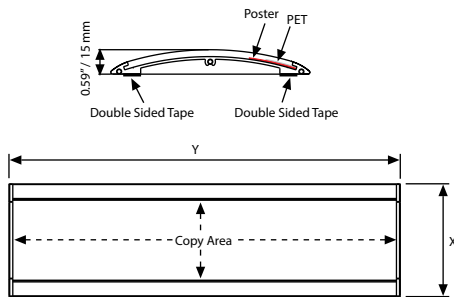

Model 4.13" / 105 mm

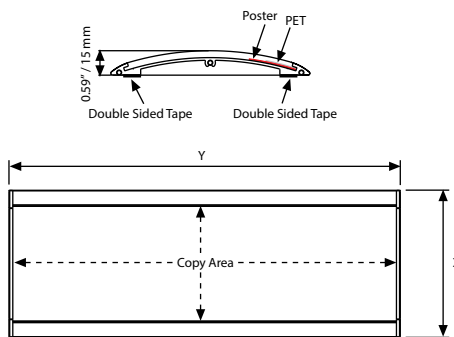

Model 5.83" / 148 mm

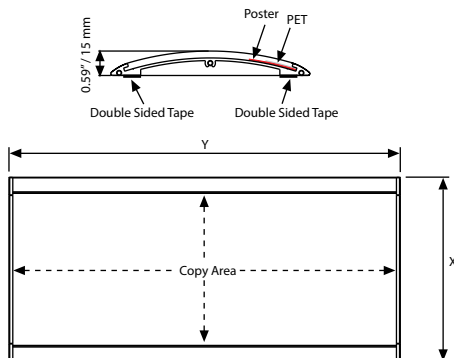

WALL SIGN SYSTEM 2.05" / 52 mm : Silver anodised aluminium					WEIGHT	PACKING SIZE (10 Pcs)
ARTICLE	MODEL	EXTERNAL (x-y)	POSTER	COPY	WITH PACKING	*W X H X D
UDS520NA10	Flat Endcap	2.68" X 4.17"	2.05" X 3.94"	1.81" X 3.94"	1.477 lbs	6.30" X 5.51" X 3.94"
UDS520NA15	Flat Endcap	2.68" X 6.14"	2.05" X 5.91"	1.81" X 5.91"	2.171 lbs	6.30" X 7.48" X 3.94"
UDS520NA20	Flat Endcap	2.68" X 8.11"	2.05" X 7.87"	1.81" X 7.87"	2.866 lbs	6.30" X 9.45" X 3.94"
UDS520NA25	Flat Endcap	2.68" X 10.08"	2.05" X 9.84"	1.81" X 9.84"	3.560 lbs	6.30" X 11.42" X 3.94"
UDS520NA30	Flat Endcap	2.68" X 12.05"	2.05" X 11.81"	1.81" X 11.81"	4.254 lbs	6.30" X 13.39" X 3.94"
UDS520NA35	Flat Endcap	2.68" X 14.02"	2.05" X 13.78"	1.81" X 13.78"	4.949 lbs	6.30" X 15.35" X 3.94"
UDS520NA40	Flat Endcap	2.68" X 15.98"	2.05" X 15.75"	1.81" X 15.75"	5.643 lbs	6.30" X 17.32" X 3.94"
UDS520NA45	Flat Endcap	2.68" X 17.95"	2.05" X 17.72"	1.81" X 17.72"	6.338 lbs	6.30" X 19.29" X 3.94"
UDS520NB10	Arc Endcap	2.68" X 4.17"	2.05" X 3.94"	1.81" X 3.70"	1.477 lbs	6.30" X 5.51" X 3.94"
UDS520NB15	Arc Endcap	2.68" X 6.14"	2.05" X 5.91"	1.81" X 5.67"	2.171 lbs	6.30" X 7.48" X 3.94"
UDS520NB20	Arc Endcap	2.68" X 8.11"	2.05" X 7.87"	1.81" X 7.64"	2.866 lbs	6.30" X 9.45" X 3.94"
UDS520NB25	Arc Endcap	2.68" X 10.08"	2.05" X 9.84"	1.81" X 9.61"	3.560 lbs	6.30" X 11.42" X 3.94"
UDS520NB30	Arc Endcap	2.68" X 12.05"	2.05" X 11.81"	1.81" X 11.57"	4.254 lbs	6.30" X 13.39" X 3.94"
UDS520NB35	Arc Endcap	2.68" X 14.02"	2.05" X 13.78"	1.81" X 13.54"	4.949 lbs	6.30" X 15.35" X 3.94"
UDS520NB40	Arc Endcap	2.68" X 15.98"	2.05" X 15.75"	1.81" X 15.51"	5.643 lbs	6.30" X 17.32" X 3.94"
UDS520NB45	Arc Endcap	2.68" X 17.95"	2.05" X 17.72"	1.81" X 17.48"	6.338 lbs	6.30" X 19.29" X 3.94"

WALL SIGN SYSTEM 2.91" / 74 mm : Silver anodised aluminium					WEIGHT	PACKING SIZE (10 Pcs)
ARTICLE	MODEL	EXTERNAL (x-y)	POSTER	COPY	WITH PACKING	*W X H X D
UDS740NA15	Flat Endcap	3.54" X 6.14"	2.91" X 5.91"	2.68" X 5.91"	2.380 lbs	8.27" X 7.48" X 3.94"
UDS740NA20	Flat Endcap	3.54" X 8.11"	2.91" X 7.87"	2.68" X 7.87"	3.152 lbs	8.27" X 9.45" X 3.94"
UDS740NA25	Flat Endcap	3.54" X 10.08"	2.91" X 9.84"	2.68" X 9.84"	3.924 lbs	8.27" X 11.42" X 3.94"
UDS740NA30	Flat Endcap	3.54" X 12.05"	2.91" X 11.81"	2.68" X 11.81"	4.629 lbs	8.27" X 13.39" X 3.94"
UDS740NA35	Flat Endcap	3.54" X 14.02"	2.91" X 13.78"	2.68" X 13.78"	5.423 lbs	8.27" X 15.35" X 3.94"
UDS740NA40	Flat Endcap	3.54" X 15.98"	2.91" X 15.75"	2.68" X 15.75"	5.533 lbs	8.27" X 17.32" X 3.94"
UDS740NA45	Flat Endcap	3.54" X 17.95"	2.91" X 17.72"	2.68" X 17.72"	6.305 lbs	8.27" X 19.29" X 3.94"
UDS740NA50	Flat Endcap	3.54" X 19.92"	2.91" X 19.69"	2.68" X 19.69"	7.098 lbs	8.27" X 21.26" X 3.94"
UDS740NB15	Arc Endcap	3.54" X 6.14"	2.91" X 5.91"	2.68" X 5.67"	2.380 lbs	8.27" X 7.48" X 3.94"
UDS740NB20	Arc Endcap	3.54" X 8.11"	2.91" X 7.87"	2.68" X 7.64"	3.152 lbs	8.27" X 9.45" X 3.94"
UDS740NB25	Arc Endcap	3.54" X 10.08"	2.91" X 9.84"	2.68" X 9.61"	3.924 lbs	8.27" X 11.42" X 3.94"
UDS740NB30	Arc Endcap	3.54" X 12.05"	2.91" X 11.81"	2.68" X 11.57"	4.629 lbs	8.27" X 13.39" X 3.94"
UDS740NB35	Arc Endcap	3.54" X 14.02"	2.91" X 13.78"	2.68" X 13.54"	5.423 lbs	8.27" X 15.35" X 3.94"
UDS740NB40	Arc Endcap	3.54" X 15.98"	2.91" X 15.75"	2.68" X 15.51"	5.533 lbs	8.27" X 17.32" X 3.94"
UDS740NB45	Arc Endcap	3.54" X 17.95"	2.91" X 17.72"	2.68" X 17.48"	6.305 lbs	8.27" X 19.29" X 3.94"
UDS740NB50	Arc Endcap	3.54" X 19.92"	2.91" X 19.69"	2.68" X 19.45"	7.098 lbs	8.27" X 21.26" X 3.94"

WALL SIGN SYSTEM 4.13" / 105 mm : Silver anodised aluminium					WEIGHT	PACKING SIZE (10 Pcs)
ARTICLE	MODEL	EXTERNAL (x-y)	POSTER	COPY	WITH PACKING	*W X H X D
UDS105NA25	Flat Endcap	4.72" X 10.08"	4.13" X 9.84"	3.90" X 9.84"	5.180 lbs	10.63" X 11.42" X 3.94"
UDS105NA30	Flat Endcap	4.72" X 12.05"	4.13" X 11.81"	3.90" X 11.81"	6.239 lbs	10.63" X 13.39" X 3.94"
UDS105NA35	Flat Endcap	4.72" X 14.02"	4.13" X 13.78"	3.90" X 13.78"	7.187 lbs	10.63" X 15.35" X 3.94"
UDS105NA40	Flat Endcap	4.72" X 15.98"	4.13" X 15.75"	3.90" X 15.75"	8.245 lbs	10.63" X 17.32" X 3.94"
UDS105NA50	Flat Endcap	4.72" X 19.92"	4.13" X 19.69"	3.90" X 19.69"	10.361 lbs	10.63" X 21.26" X 3.94"
UDS105NA60	Flat Endcap	4.72" X 23.86"	4.13" X 23.62"	3.90" X 23.62"	12.919 lbs	10.63" X 25.20" X 3.94"
UDS105NB25	Arc Endcap	4.72" X 10.08"	4.13" X 9.84"	3.90" X 9.61"	5.180 lbs	10.63" X 11.42" X 3.94"
UDS105NB30	Arc Endcap	4.72" X 12.05"	4.13" X 11.81"	3.90" X 11.57"	6.239 lbs	10.63" X 13.39" X 3.94"
UDS105NB35	Arc Endcap	4.72" X 14.02"	4.13" X 13.78"	3.90" X 13.56"	7.187 lbs	10.63" X 15.35" X 3.94"
UDS105NB40	Arc Endcap	4.72" X 15.98"	4.13" X 15.75"	3.90" X 15.51"	8.245 lbs	10.63" X 17.32" X 3.94"
UDS105NB50	Arc Endcap	4.72" X 19.92"	4.13" X 19.69"	3.90" X 19.45"	10.361 lbs	10.63" X 21.26" X 3.94"
UDS105NB60	Arc Endcap	4.72" X 23.86"	4.13" X 23.62"	3.90" X 23.39"	12.919 lbs	10.63" X 25.20" X 3.94"

WALL SIGN SYSTEM 5.83" / 148 mm : Silver anodised aluminium					WEIGHT	PACKING SIZE (10 Pcs)
ARTICLE	MODEL	EXTERNAL (x-y)	POSTER	COPY	WITH PACKING	*W X H X D
UDS148NA30	Flat Endcap	6.38" X 12.05"	5.83" X 11.81"	5.59" X 11.81"	7.407 lbs	14.17" X 13.39" X 3.94"
UDS148NA35	Flat Endcap	6.38" X 14.02"	5.83" X 13.78"	5.59" X 13.78"	8.730 lbs	14.17" X 15.35" X 3.94"
UDS148NA40	Flat Endcap	6.38" X 15.98"	5.83" X 15.75"	5.59" X 15.75"	10.008 lbs	14.17" X 17.32" X 3.94"
UDS148NA50	Flat Endcap	6.38" X 19.92"	5.83" X 19.69"	5.59" X 19.69"	12.478 lbs	14.17" X 21.26" X 3.94"
UDS148NA60	Flat Endcap	6.38" X 23.86"	5.83" X 23.62"	5.59" X 23.62"	15.123 lbs	14.17" X 25.20" X 3.94"
UDS148NA65	Flat Endcap	6.38" X 25.83"	5.83" X 25.59"	5.59" X 25.59"	16.336 lbs	14.17" X 27.17" X 3.94"
UDS148NB30	Arc Endcap	6.38" X 12.05"	5.83" X 11.81"	5.59" X 11.57"	7.407 lbs	14.17" X 13.39" X 3.94"
UDS148NB35	Arc Endcap	6.38" X 14.02"	5.83" X 13.78"	5.59" X 13.54"	8.730 lbs	14.17" X 15.35" X 3.94"
UDS148NB40	Arc Endcap	6.38" X 15.98"	5.83" X 15.75"	5.59" X 15.51"	10.008 lbs	14.17" X 17.32" X 3.94"
UDS148NB50	Arc Endcap	6.38" X 19.92"	5.83" X 19.69"	5.59" X 19.45"	12.478 lbs	14.17" X 21.26" X 3.94"
UDS148NB60	Arc Endcap	6.38" X 23.86"	5.83" X 23.62"	5.59" X 23.39"	15.123 lbs	14.17" X 25.20" X 3.94"
UDS148NB65	Arc Endcap	6.38" X 25.83"	5.83" X 25.59"	5.59" X 25.35"	16.336 lbs	14.17" X 27.17" X 3.94"





*W:Width H: Height D: Depth

Wall Sign Double Sided



Fast and Simple! Aluminium wall sign profiles are designed to create horizontally curved double sided suspended signs. Using your stock of single sided profiles, product offerings can be increased to double sided suspension style. Double Sided Wall Sign is suitable as directional signs, way finding. Suspension cables enclosed enables flexible positioning of the sign. Black endcaps complete the look.

 Use the suction cup enclosed to easily remove the insert. Peel the tape on the backing and stick for easy application.

 Compatible signage methods; printed papers from common printers, cut vinyl, digitally printed vinyl, screen-printed materials.

 Ceiling suspension is included in the pack (31.50" wire cable & 2 x ceiling hanger). Individually packed.

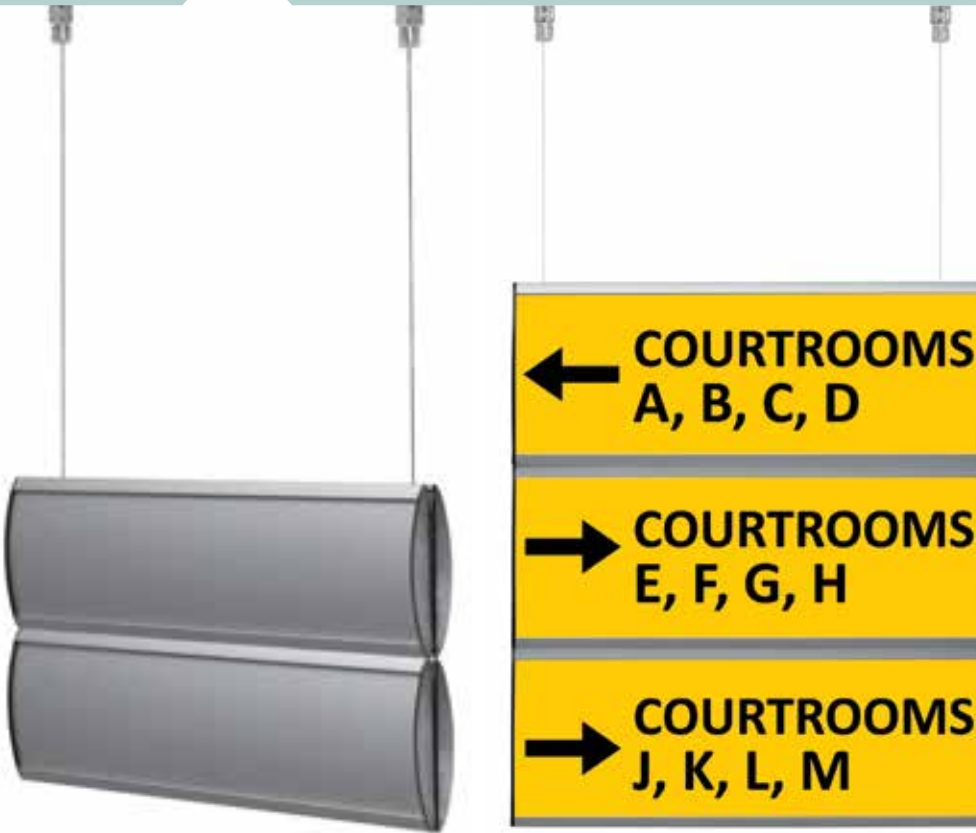

- ✓ Anti-reflex PET covers ensure clarity of message.
- ✓ Easy to access poster with suction cup provided in the pack.
- ✓ Easy to update messages. Suitable for paper, plastic or any flexible material up to 0.04" thick.
- ✓ Available in standard sizes as well as bespoke sizes (subjected to moq).
- ✓ For more than 5 layers please contact to your sales executive.



Suction Cup / UYAA006010



Fixing components (UYPDS00002)
Suspension set (UYPDS00001)

Maximum recommended length: 19,69"m

WALL SIGN DOUBLE SIDED		
ARTICLE	DESCRIPTION	WEIGHT
UYPDS00001	Double Sided Suspension Set / 2x157.48" fishnet & 2xCeiling Hanger	0.992 lbs
UYPDS00002	Double Sided Fixing Set (4 Pcs)	0.110 lbs

WALL SIGN DOUBLE SIDED: Silver anodised aluminium	WALL SIGN DOUBLE SIDED: Silver anodised aluminium				
	SINGLE LAYER	2- LAYER	3-LAYER	4- LAYER	5- LAYER
2.91"	✓	✓	✓	✓	✓
4.13"	✓	✓	✓	✓	
5.83"	✓	✓	✓		



Toilet Logo Systems Chrome



Chrome coated 3D toilet signs are available for men and women in 3.62" and clean neat finish add value to the signs. Easy to apply on the door or wall with self-adhesive tape provided on the back of each sign.

 Peel the tape and stick backing for easy application. Please clean the surface before applying the double-sided tape for better application.

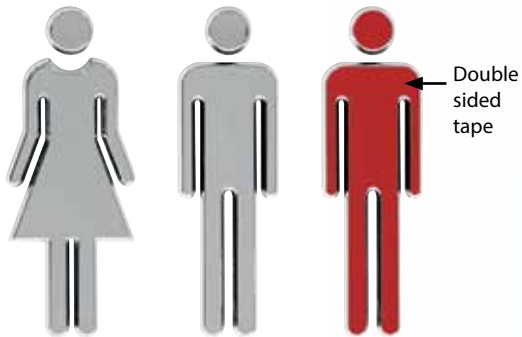

peel & stick

TDFJ92W002 Chromed Toilet Signs, Women
TDFJ92X002 Chromed Toilet Signs, Men
Back Side



TDFJ100C01 Chromed Toilet Signs, Handicap, Grey Panel
TDFJ100W01 Chromed Toilet Signs, Women, Grey Panel
TDFJ100X01 Chromed Toilet Signs, Men, Grey Panel
Back Side

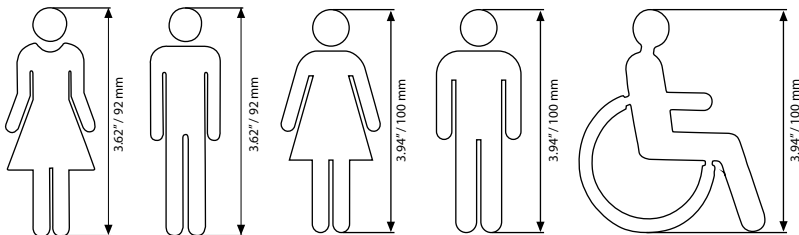

MATERIAL: Chrome			WEIGHT	PACKING SIZE
ARTICLE	HEIGHT	DESCRIPTION	WITH PACKING	*W X H X D
TDFJ92X002	3.62"	Silver - Men	0.017 lbs	5.71" X 7.68" X 4.33" (50 pcs)
TDFJ92W002	3.62"	Silver - Women	0.017 lbs	5.71" X 7.68" X 4.33" (50 pcs)
TDFJ100X01	3.94"	Milky White - Men	0.030 lbs	6.89" X 7.87" X 4.33" (50 pcs)
TDFJ100W01	3.94"	Milky White - Women	0.030 lbs	6.89" X 7.87" X 4.33" (50 pcs)
TDFJ100C01	3.94"	Milky White - Handicap	0.028 lbs	6.89" X 7.87" X 4.33" (50 pcs)

*W:Width H: Height D: Depth



Decorative Toilet Signs



Oval shape plastic injected toilet signs has both colour and size options: Gold, Silver and Bronze & 4.72" and 5.91" heights. Braided frame and leather-textured backing completes elegant look.

Peel the tape and stick backing for easy application. Please clean the surface before applying the double-sided tape for better application.



Silver Frame, Dark Grey Panel, Men



Silver Frame, Dark Grey Panel, Women



Gold Frame, Dark Grey Panel, Men



Gold Frame, Dark Grey Panel, Women



Bronze Frame, Dark Grey Panel, Men



Bronze Frame, Dark Grey Panel, Women



Double sided tape

Back

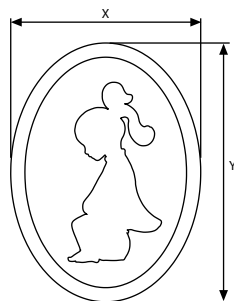
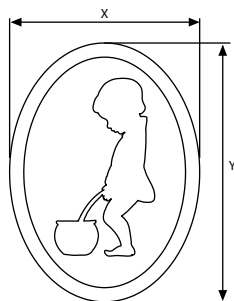

MATERIAL: Plastic injected			WEIGHT	PACKING SIZE
ARTICLE	EXTERNAL (x-y)	DESCRIPTION	WITH PACKING	*W X H X D
TDFY28LF03	3.46" X 4.72"	Gold- Men	0.088 lbs	8.07" X 9.45" X 6.69" (50 pcs)
TDFY28WF03	3.46" X 4.72"	Gold- Women	0.088 lbs	8.07" X 9.45" X 6.69" (50 pcs)
TDFY29LF02	4.33" X 5.91"	Silver- Men	0.145 lbs	9.25" X 12.99" X 6.89" (50 pcs)
TDFY29WF02	4.33" X 5.91"	Silver- Women	0.145 lbs	9.25" X 12.99" X 6.89" (50 pcs)
TDFY31LF04	4.33" X 5.91"	Bronze- Men	0.145 lbs	9.25" X 12.99" X 6.89" (50 pcs)
TDFY31WF04	4.33" X 5.91"	Bronze- Women	0.145 lbs	9.25" X 12.99" X 6.89" (50 pcs)

*W:Width H: Height D: Depth



Aluminum Panel Braille Signs



Aluminium Braille Toilet Signs are plastic framed. The signs are incorporated a combination of tactile text and printed text. It is available in Men and Women options. Easy to apply with double sided tape provided on the back of each sign.

 Peel the tape and stick backing for easy application. Please clean the surface before applying the double-sided tape for better application.

5"x5" Aluminium Panel Braille Signs



5"x5"-No Smoking, Silver Plastic Frame Aluminum Panel With Braille

6"x8" Aluminium Panel Braille Signs



6" x 8"-Men, Silver Plastic Frame Aluminum Panel With Braille



6" x 8"-Female, Silver Plastic Frame Aluminum Panel With Braille

6"x6" Aluminium Panel Braille Signs



6" x 6"-Men, Silver Plastic Frame Aluminum Panel With Braille



6" x 6"-Female, Silver Plastic Frame Aluminum Panel With Braille



5"x5" Aluminium Panel Braille Signs

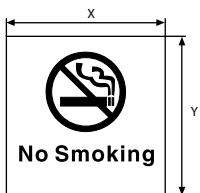

6"x6" Aluminium Panel Braille Signs

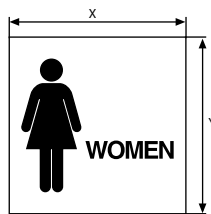

6"x8" Aluminium Panel Braille Signs

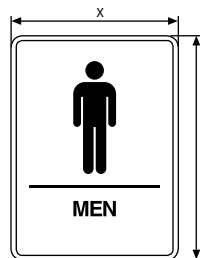

5"x5": Aluminium			WEIGHT	PACKING SIZE
ARTICLE	EXTERNAL (x-y)	DESCRIPTION	WITH PACKING	*W X H X D
TDFL110002	5" X 5"	Silver	0.145 lbs	9.25" X 16.54" X 8.07" (50 pcs)
6" X 8": Aluminium			WEIGHT	PACKING SIZE
ARTICLE	EXTERNAL (x-y)	DESCRIPTION	WITH PACKING	*W X H X D
TDFL070002	6" X 8"	Silver- Men	0.313 lbs	9.25" X 16.54" X 8.07" (50 pcs)
TDFL080002	6" X 8"	Silver - Women	0.313 lbs	9.25" X 16.54" X 8.07" (50 pcs)
6" X 6": Aluminium			WEIGHT	PACKING SIZE
ARTICLE	EXTERNAL (x-y)	DESCRIPTION	WITH PACKING	*W X H X D
TDFL050002	6" X 6"	Silver- Men	0.246 lbs	9.25" X 16.54" X 8.07" (50 pcs)
TDFL060002	6" X 6"	Silver - Women	0.246 lbs	9.25" X 16.54" X 8.07" (50 pcs)

* W:Width H: Height D: Depth



ABS Plastic Braille Signs



Chrome framed Braille Signs are made of plastics. The signs incorporated a combination of tactile text and printed text. It has Men, Women, No Smoking and Exit options. Easy to apply with self-adhesive tape provided on the back of each sign.

 Peel the tape and stick backing for easy application. Please clean the surface before applying the double-sided tape for better application.



WOMEN, Braille signs. With double-side tape on the back.



MEN, Braille signs. With double-side tape on the back.



EXIT, braille signs. With double-side tape on the back.



NO SMOKING, braille signs. With double-side tape on the back.



Back side

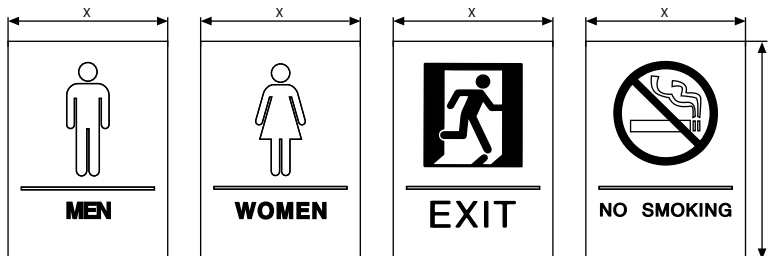

MATERIAL: Aluminium			WEIGHT	PACKING SIZE
ARTICLE	EXTERNAL (x-y)	DESCRIPTION	WITH PACKING	*W X H X D
TDFY010002	6" X 8"	Silver - Men	0.396 lbs	9.25" X 12.99" X 9.25" (50 pcs)
TDFY020002	6" X 8"	Silver - Women	0.396 lbs	9.25" X 12.99" X 9.25" (50 pcs)
TDFY090002	6" X 8"	Silver - No Smoking	0.396 lbs	9.25" X 12.99" X 9.25" (50 pcs)
TDFY100002	6" X 8"	Silver - Exit	0.396 lbs	9.25" X 12.99" X 9.25" (50 pcs)

*W:Width H: Height D: Depth



Plastic Chromed House Numbers



Chrome coated plastic House Numbers offered in a pack 0-9. Easy to apply on various surfaces with self-adhesive tape on the back of each sign.

 Peel the tape and stick backing for easy application.

 One pack includes 0-9.

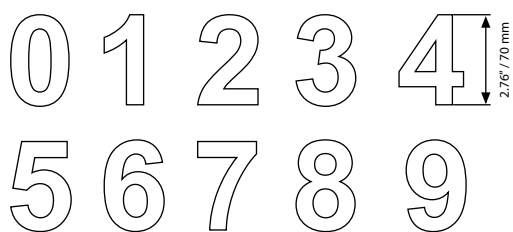

MATERIAL: Chrome coated plastic			WEIGHT	PACKING SIZE
ARTICLE	HEIGHT	DESCRIPTION	WITH PACKING	*W X H X D
TDFH700002	2.76"	Silver - 0-9	0.030 lbs	10.04" X 12.20" X 13.19" (50 pcs)

* W:Width H: Height D: Depth



Clip Board



See movie at our website www.mtdisplays.com.tr



Heavy duty, textured steel Clip Board is designed for the most demanding environments such as healthcare, offices, catering and any outdoor work. Stain free surface allows easy cleaning of the product. It is complete with silver anodised, strong and high capacity snap-open clip. Round corners allows using in busy work areas.

Suitable for A4 papers. Standard with paper clip and magnet on the back. Peel the tape and stick backing for easy application. Please clean the surface before applying the double-sided tape for better application.

Optional steel bar for hanging in multiples of 8.5"x11". Should be ordered separately! Steel bar has double sided tape at the back for wall application.



Magnetic buttons
UYUP397000

1X(8.5"x11") Clip Board
Steel bar length 11.81"x1.38"mm

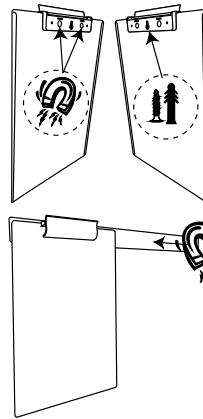
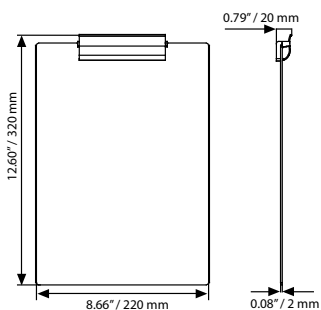

2X(8.5"x11") Clip Board
Steel bar length 18.11"x1.38"

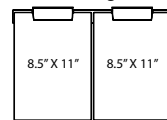

3X(8.5"x11") Clip Board
Steel bar length 27.56"x1.38"

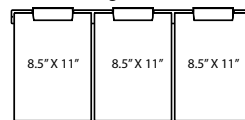

4X(8.5"x11") Clip Board
Steel bar length 37.01"x1.38"

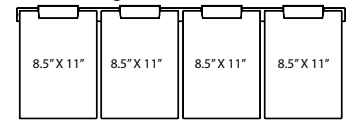

MATERIAL : Steel powder coated			WEIGHT	PACKING SIZE
ARTICLE	DESCRIPTION	CAPACITY	WITH PACKING	*W X H X D
UCIB000A4	CLIP BOARD	8.5" X 11"	2.645 lbs	9.84" X 13.78" X 0.83"
UCIBD002A4	CLIP BOARD WALL UNIT	2 X (8.5" X 11")	0.617 lbs	3.15" X 4.72" X 4.92" (5 Pcs)
UCIBD003A4	CLIP BOARD WALL UNIT	3 X (8.5" X 11")	0.661 lbs	3.15" X 4.72" X 4.92" (5 Pcs)
UCIBD004A4	CLIP BOARD WALL UNIT	4 X (8.5" X 11")	0.925 lbs	3.15" X 4.72" X 4.92" (5 Pcs)



*W:Width H: Height D: Depth

Fast Note



See movie at our website www.mtdisplays.com.tr

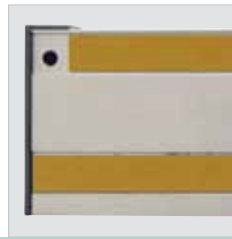

Fast Note is a product which enables you to hang your papers, notes, pictures or photos without magnets or pins. It has a slim and compact design. Thanks to the cylinders in the profile you can easily keep the paper inside. Fast Note is suitable for restaurants, agencies, studios, hospitals, hotels, conference rooms, houses and offices. The standard color is anodized silver. Other colors and sizes are available upon request. You can either assemble the product on the wall by fixing the holes on the profile with screws and wall-plugs or apply the double-sided tape at any given point.

 It is user friendly. Fixing set (screw and double-sided tape) and manual is supplied with each product. Suitable for use of posters / paper min. 0.003", max. 0.0314" thickness.

 Suitable for silk screen printing, max. letter height is 0.55".

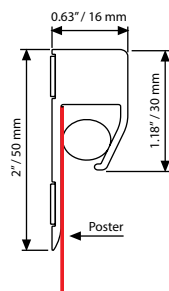
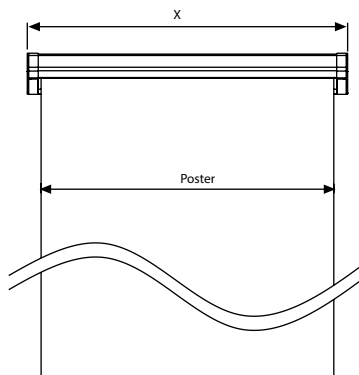
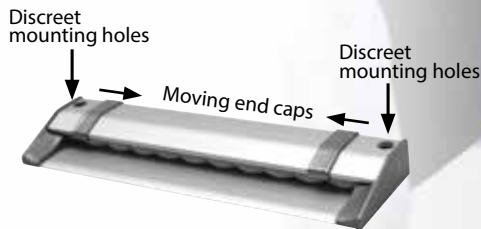

MATERIAL : Silver anodised aluminium			WEIGHT	PACKING SIZE
ARTICLE	EXTERNAL (x)	POSTER	WITH PACKING	*W X H X D
UFN000N012	12.98"	12"	17.636 lbs	8.66" X 14.17" X 12.60" (50 pcs)
UFN000N024	24.98"	24"	35.273 lbs	8.66" X 26.38" X 12.60" (50 pcs)
UFN000N036	36.98"	36"	26.455 lbs	7.09" X 38.39" X 8.66" (25 pcs)
UFN000N040	40.98"	40"	28.660 lbs	7.09" X 42.32" X 8.66" (25 pcs)
UFN000N060	60.98"	60"	41.887 lbs	7.09" X 62.60" X 8.66" (25 pcs)



*W:Width H: Height D: Depth



Magnetic Glass Board



Both magnetic and dry wipe, Magnetic Glass Board offers a smart solution for offices, colleagues, meeting rooms, hotels, cafes and more. Red, Black and White colour options will suit various contemporary decoration. Tempered glass increases the strength against damages. Magnets, pen holder, eraser and pen included in the pack for comfortable immediate use.

-  Each unit is packed individual in carton box.
-  Landscape/portrait wall mounting.
-  Accessories (rubber&marker&magnets) are included in the original box.

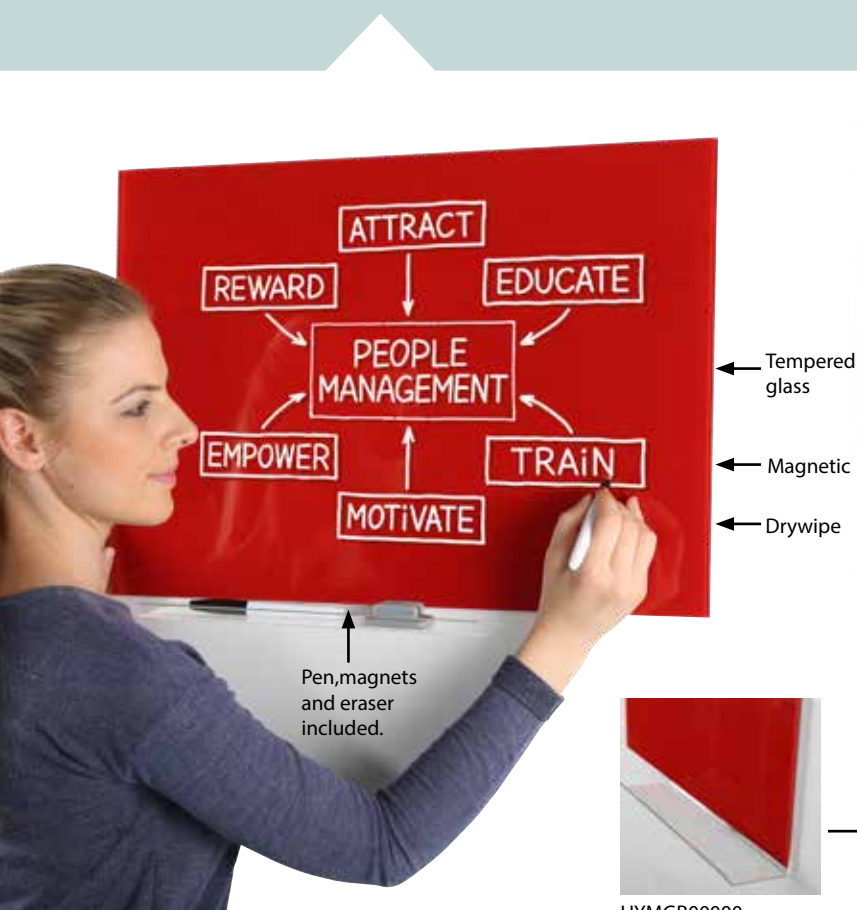

Pen, magnets and eraser included.

- ← Tempered glass
- ← Magnetic
- ← Drywipe



UYMGB00000 Shelves are optional accessories.

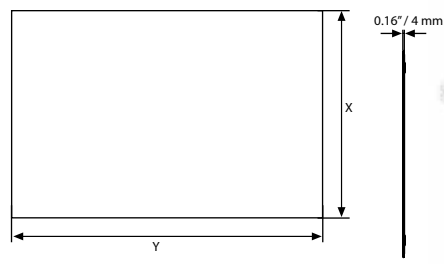

MATERIAL : Tempered glass			WEIGHT	PACKING SIZE
ARTICLE	SIZE (x-y)	COLOUR	WITH PACKING	*W X H X D
TOOMGB0335	13.78" X 13.78"	White	3.527 lbs	14.96" X 15.35" X 1.77"
TOOMGB0135	13.78" X 13.78"	Black	3.527 lbs	14.96" X 15.35" X 1.77"
TOOMGB0435	13.78" X 13.78"	Red	3.527 lbs	14.96" X 15.35" X 1.77"
TOOMGB0345	17.72" X 17.72"	White	5.820 lbs	18.90" X 19.29" X 1.77"
TOOMGB0145	17.72" X 17.72"	Black	5.820 lbs	18.90" X 19.29" X 1.77"
TOOMGB0445	17.72" X 17.72"	Red	5.820 lbs	18.90" X 19.29" X 1.77"
TOOMGB0346	15.75" X 23.62"	White	6.878 lbs	17.32" X 25.20" X 1.77"
TOOMGB0146	15.75" X 23.62"	Black	6.878 lbs	17.32" X 25.20" X 1.77"
TOOMGB0446	15.75" X 23.62"	Red	6.878 lbs	17.32" X 25.20" X 1.77"
TOOMGB0369	23.62" X 35.43"	White	15.873 lbs	26.77" X 38.58" X 1.77"
TOOMGB0169	23.62" X 35.43"	Black	15.873 lbs	26.77" X 38.58" X 1.77"
TOOMGB0469	23.62" X 35.43"	Red	15.873 lbs	26.77" X 38.58" X 1.77"

*W:Width H: Height D: Depth



Business Card Holder



The clear Business Card Holder is good to organize your business and a perfect tool for professional appearance. This card holder is available in stock, ready for shipment and boxed in 40's.

! Please handle with care during transportation.



Clear



Turquoise



Black

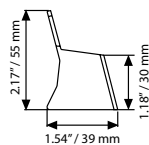
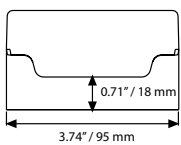
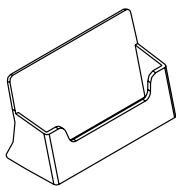

MATERIAL : Clear		WEIGHT	PACKING SIZE
ARTICLE	DESCRIPTOIN	WITH PACKING	*W X H X D
UMSD009000	Clear	2.843 lbs	9.65" X 13.78" X 3.39" (40 pcs)
UMSD009B00	Black	2.843 lbs	9.65" X 13.78" X 3.39" (40 pcs)
UMSD009T00	Turquoise	2.843 lbs	9.65" X 13.78" X 3.39" (40 pcs)



*W:Width H: Height D: Depth

Coat Racks

Designed for beauty and function, these coat racks are suitable for home or office use. 8 different models are offered with different accessories and functions. All models are heavy and sturdy for stability. They support up to 55.115 lbs in average.



Coat Hanger Stand

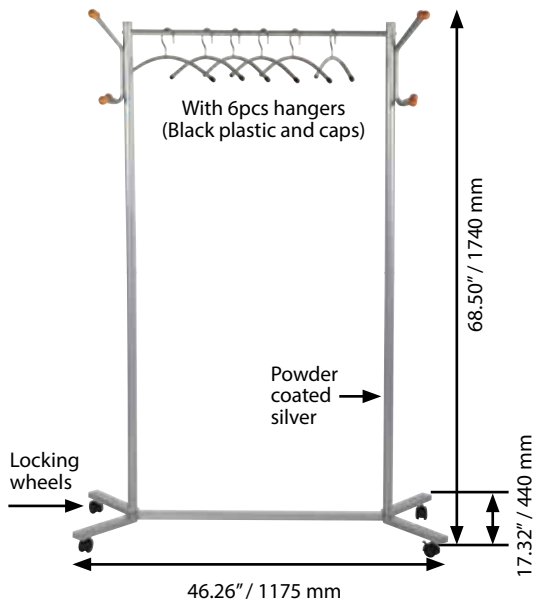

MATERIAL : Steel		WEIGHT	PACKING SIZE
ARTICLE	SIZE	DESCRIPTION	*W X H X D
TWJD000303	46.26" X 17.32" X 68.50"	Silver	12.345 lbs 35.04" X 12.01" X 3.54"



*W:Width H:Height D:Depth

Trio Coat Rack

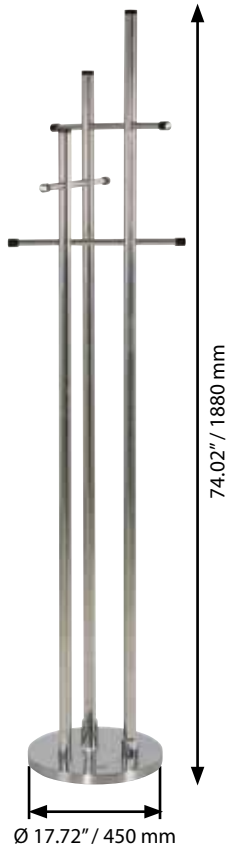

Spring Coat Rack

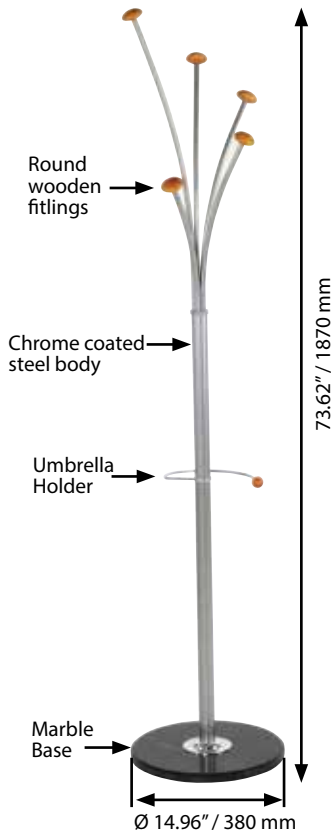

TRIO: Steel			WEIGHT	PACKING SIZE
ARTICLE	SIZE	DESCRIPTION	WITH PACKING	*W X H X D
TXXY809A01	17.72" X 1.77" X 74.02"	Silver	20.502 lbs	73.62" X 4.33" X 1.97"
				16.14" X 16.14" X 1.97"

TP 2 YEAR WARRANTY

- Black knob accessories
- Packaging: single packed
- Easy assembling
- Gross weight: 20.502 lbs.

2 packs. See info chart for pack sizes.



SPRING: Steel			WEIGHT	PACKING SIZE
ARTICLE	SIZE	DESCRIPTION	WITH PACKING	*W X H X D
TWJD856003	14.96" X 14.96" X 73.62"	Silver	20.723 lbs	28.35" X 15.24" X 3.46"

TP 2 YEAR WARRANTY

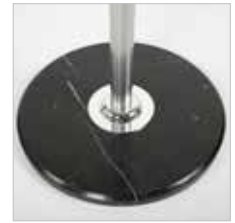

Pine Coat Rack



Sunflower Coat Rack

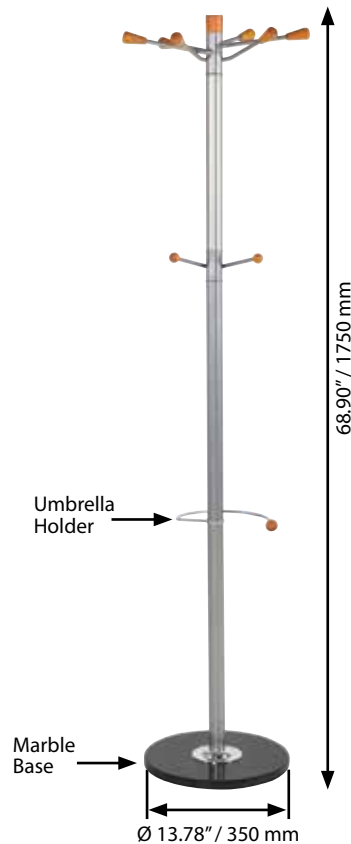

PINE: Steel			WEIGHT	PACKING SIZE
ARTICLE	SIZE	DESCRIPTION	WITH PACKING	*W X H X D
TWJD824403	13.78" X 13.78" X 68.90"	Silver	17.857 lbs	23.23" X 14.37" X 5.31"

TP 2 YEAR WARRANTY

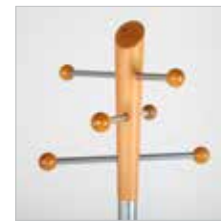

SUNFLOWER: Steel			WEIGHT	PACKING SIZE
ARTICLE	SIZE	DESCRIPTION	WITH PACKING	*W X H X D
TWJD824403	13.78" X 13.78" X 72.44"	Silver	17.416 lbs	20.47" X 14.06" X 3.62"

TP 2 YEAR WARRANTY



Fountain Coat Rack

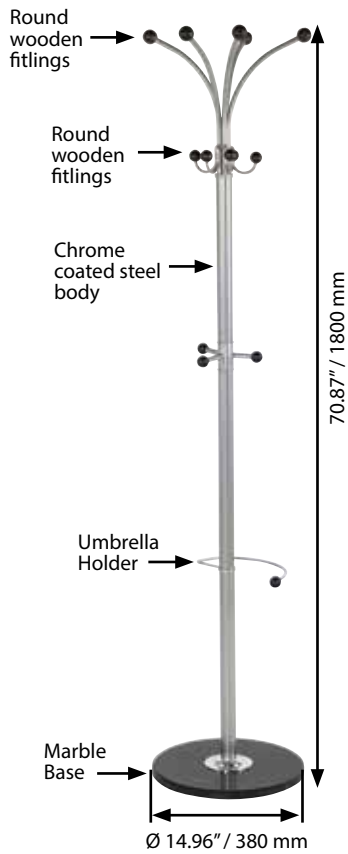

Ladder Coat Rack

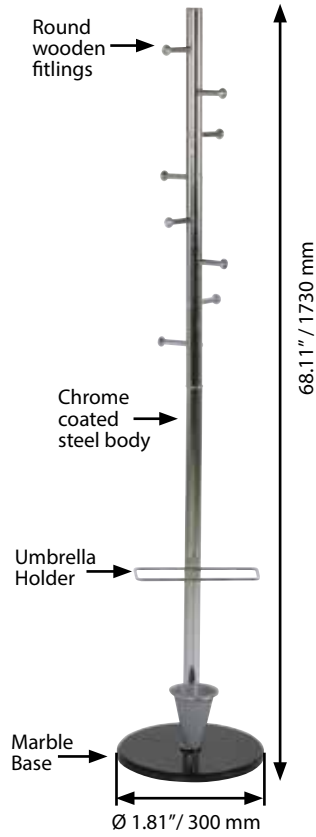

FOUNDATION : Steel			WEIGHT	PACKING SIZE
ARTICLE	SIZE	DESCRIPTION	WITH PACKING	*W X H X D
TWJD888003	14.96" X 14.96" X 70.87"	Silver	21.384 lbs	23.23" X 15.24" X 3.74"



* W:Width H: Height D: Depth



LADDER : Steel			WEIGHT	PACKING SIZE
ARTICLE	SIZE	DESCRIPTION	WITH PACKING	*W X H X D
TWJD828103	11.81" X 11.81" X 68.11"	Silver	15.652 lbs	34.65" X 12.20" X 4.72"



* W:Width H: Height D: Depth



Maze Coat Rack

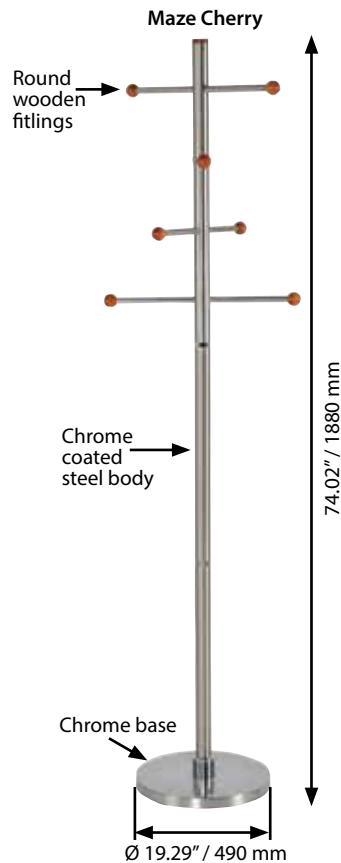
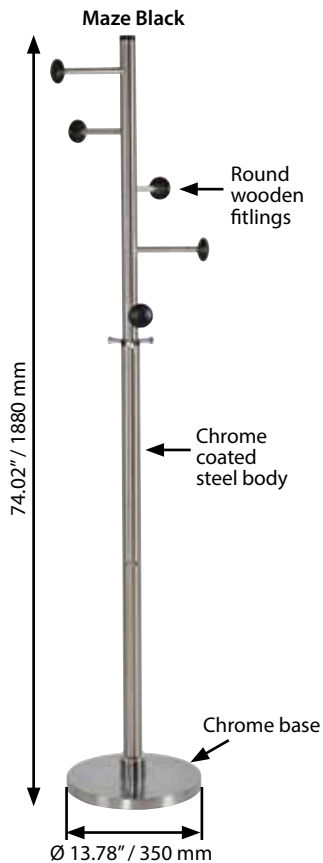

MAZE : Steel			WEIGHT	PACKING SIZE
ARTICLE	SIZE	DESCRIPTION	WITH PACKING	*W X H X D
TXXY801001	19.29" X 19.29" X 74.02"	Cherry	14.550 lbs	28.15" X 3.54" X 14.76"
TXXY808A01	13.78" X 13.78" X 74.02"	Black	14.991 lbs	28.15" X 3.54" X 14.76"



* W:Width H: Height D: Depth

- Cherry wood or black knob accessoires
- Packaging: single packed
- Easy assembling
- Gross weight: 14.550 lbs.



Waste Baskets

These Waste Baskets are mainly made of stainless steel for hygienic reasons. All models easily incorporate in contemporary office buildings, lounges, lobby or at an entryway to promote paper litter disposal. Available in different capacities, finishes and functions.



Flat Pedal Trash Can

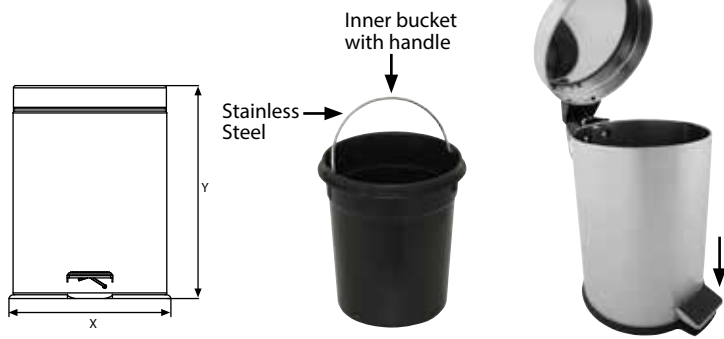

MATERIAL : Stainless Steel				WEIGHT	PACKING SIZE
ARTICLE	SIZE (x-y)	DESCRIPTION	CAPACITY	WITH PACKING	*W X H X D
TJIPT90A01	Ø6.61" X 10.16"	Silver	101 ounce	2.131 lbs	7.48" X 10.63" X 10.24"
TJIPT90B01	Ø8.07" X 10.63"	Silver	169 ounce	2.718 lbs	9.06" X 11.81" X 11.81"
TJIPT90C01	Ø12.01" X 17.72"	Silver	676 ounce	7.054 lbs	12.99" X 15.75" X 18.90"

* W:Width H: Height D: Depth



676 ounce - Stainless Steel



169 ounce - Stainless Steel



101 ounce - Stainless Steel

Hotel Trash Can



MATERIAL : Stainless Steel				WEIGHT	PACKING SIZE
ARTICLE	SIZE (x-y)	DESCRIPTION	CAPACITY	WITH PACKING	*W X H X D
TJIHT95A01	Ø8.07" X 22.83"	Silver	405 ounce	4.629 lbs	9.06" X 23.62" X 9.84"
TJIHT95B01	Ø11.81" X 23.82"	Silver-with inner bucket	1014 ounce	8.598 lbs	12.99" X 25.59" X 12.99"
TJIHT95B02	Ø11.81" X 23.82"	Black-with inner bucket	1014 ounce	8.818 lbs	12.99" X 25.59" X 12.99"

* W:Width H: Height D: Depth



1014 ounce - Stainless Steel with inner bucket



1014 ounce - Black powder coating with inner bucket



405 ounce - Stainless Steel

Hotel Trash Can Inner Bucket



MATERIAL : Stainless Steel				WEIGHT	PACKING SIZE
ARTICLE	SIZE (x-y)	DESCRIPTION	CAPACITY	WITH PACKING	*W X H X D
TJIHT58001	Ø9.84" X 23.62"	Silver	608 ounce	6.834 lbs	11.02" X 25.20" X 11.02"
TJIHT58002	Ø9.84" X 23.62"	Black	608 ounce	6.834 lbs	11.02" X 25.20" X 11.02"

* W:Width H: Height D: Depth



608 ounce - Black



608 ounce - Silver

Mirror Finish Stainless Steel

Stainless Steel Push Can Dust Bin

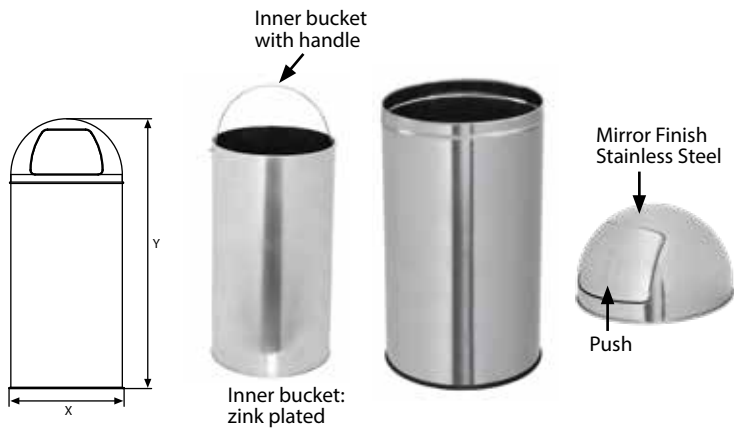

MATERIAL : Stainless Steel				WEIGHT	PACKING SIZE
ARTICLE	SIZE (x-y)	DESCRIPTION	CAPACITY	WITH PACKING	*W X H X D
TJIDB96A01	Ø8.07" X 23.62"	Silver	845 ounce	7.716 lbs	11.02" X 25.20" X 11.02"
TJIDB96B01	Ø11.61" X 25.98"	Silver	1183 ounce	9.369 lbs	12.99" X 25.59" X 12.99"
TJIDB96C01	Ø13.78" X 29.92"	Silver	1690 ounce	13.668 lbs	14.96" X 32.50" X 14.96"

*W:Width H: Height D:Depth



Stainless Steel Waste Basket Singel Wall

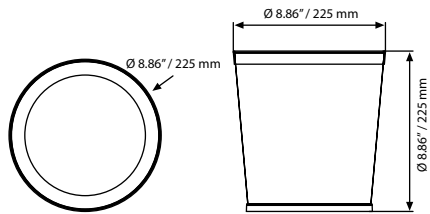

MATERIAL : Stainless Steel			WEIGHT	PACKING SIZE
ARTICLE	DESCRIPTION	WEIGHT	WITH PACKING	*W X H X D
TJIWB93S01	Silver	1.653 lbs	2.425 lbs	9.84" X 11.42" X 9.84"
TJIWB93S02	Black	1.653 lbs	2.425 lbs	9.84" X 11.42" X 9.84"

*W:Width H: Height D: Depth



Stainless Steel Waste Basket Double Wall

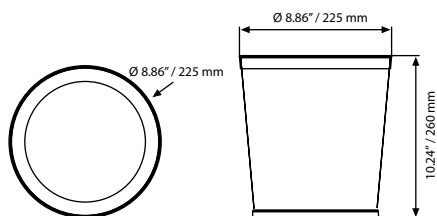

MATERIAL : Stainless Steel			WEIGHT	PACKING SIZE
ARTICLE	DESCRIPTION	WEIGHT	WITH PACKING	*W X H X D
TJIWB93D01	Silver	2.645 lbs	3.141 lbs	9.84" X 11.81" X 9.84"
TJIWB93D02	Black	2.645 lbs	3.527 lbs	9.84" X 11.81" X 9.84"

*W:Width H: Height D: Depth



Stainless Steel Stand-up Ashtray

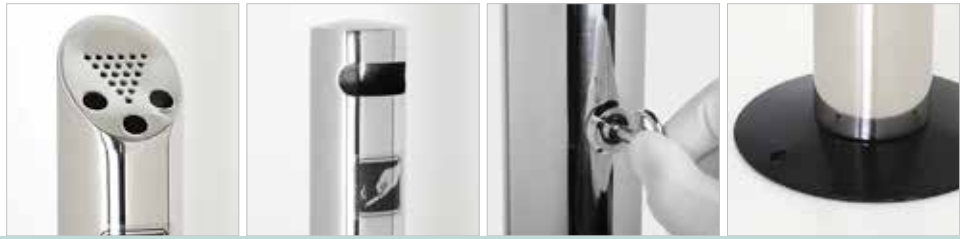

Stainless Steel Stand-up Ashtray angled top is made of stainless steel and have mixture of mirror look and matt finish. Top part can be removed by opening the lock in the middle with an allen key which is provided with the product. It is an outdoor product and can be secured on the floor using screws with the holes under the base.

 No assembly required. Allen key (included).

 Fixing for ground mounting included.

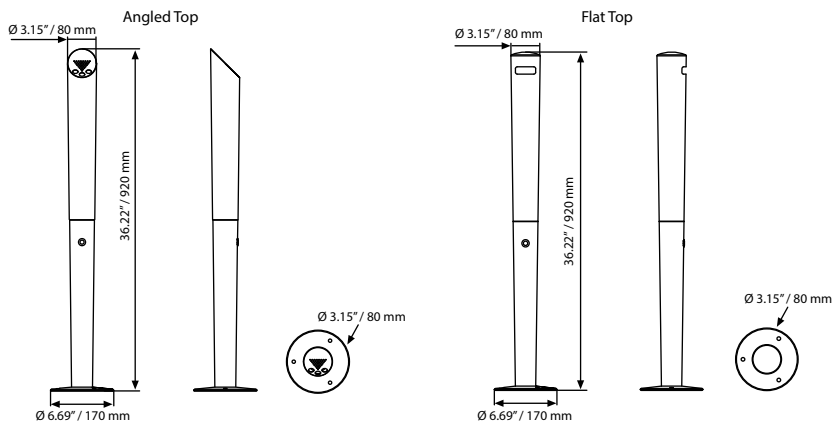

MATERIAL : Stainless Steel		WEIGHT		PACKING SIZE
ARTICLE	DESCRIPTION	WEIGHT	WITH PACKING	*W X H X D
TJISA26901	Silver - Angle Top	11.684 lbs	13.889 lbs	8.27" X 37.80" X 8.27"
TJISA26301	Silver - Flat Top	13 lbs	15.211 lbs	8.27" X 37.80" X 8.27"

*W:Width H: Height D: Depth



2 Step Stepstool

new

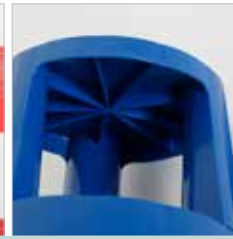

See movie at our website www.mtdisplays.com.tr

Stay safe while reaching higher places at office, library, shops or even at home. 2-Step Plastic Stepstool is a tool that can be easily used and available in 4 colors (Black, Red, Blue, Grey) to match your decoration. It tolerates up to 330.693 lbs without losing its looks. Can be easily moved around with spring loaded castors. Made from durable PP material.



Easily moved by the rollers.



Available in 4 colours : black, blue, grey, red.



Maximum loading capacity 330.693 lbs.



Assembly in 4 seconds.



UPSS200002
Grey



UPSS200003
Red

← Antislip surface.



Max. load 330.693 lbs



UPSS200001
Black



UPSS200004
Blue



Antislip rubber base. Locking wheel system.

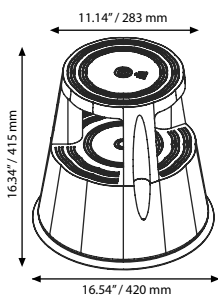

MATERIAL : PP		WEIGHT	PACKING SIZE
ARTICLE	DESCRIPTION	WITH PACKING	*W X H X D
UPSS200001	Black	5.401 lbs	17.13" X 17.13" X 9.45"
UPSS200002	Grey	5.401 lbs	17.13" X 17.13" X 9.45"
UPSS200003	Red	5.401 lbs	17.13" X 17.13" X 9.45"
UPSS200004	Blue	5.401 lbs	17.13" X 17.13" X 9.45"

*W:Width H: Height D: Depth





Håndarbejde



Presentation Systems

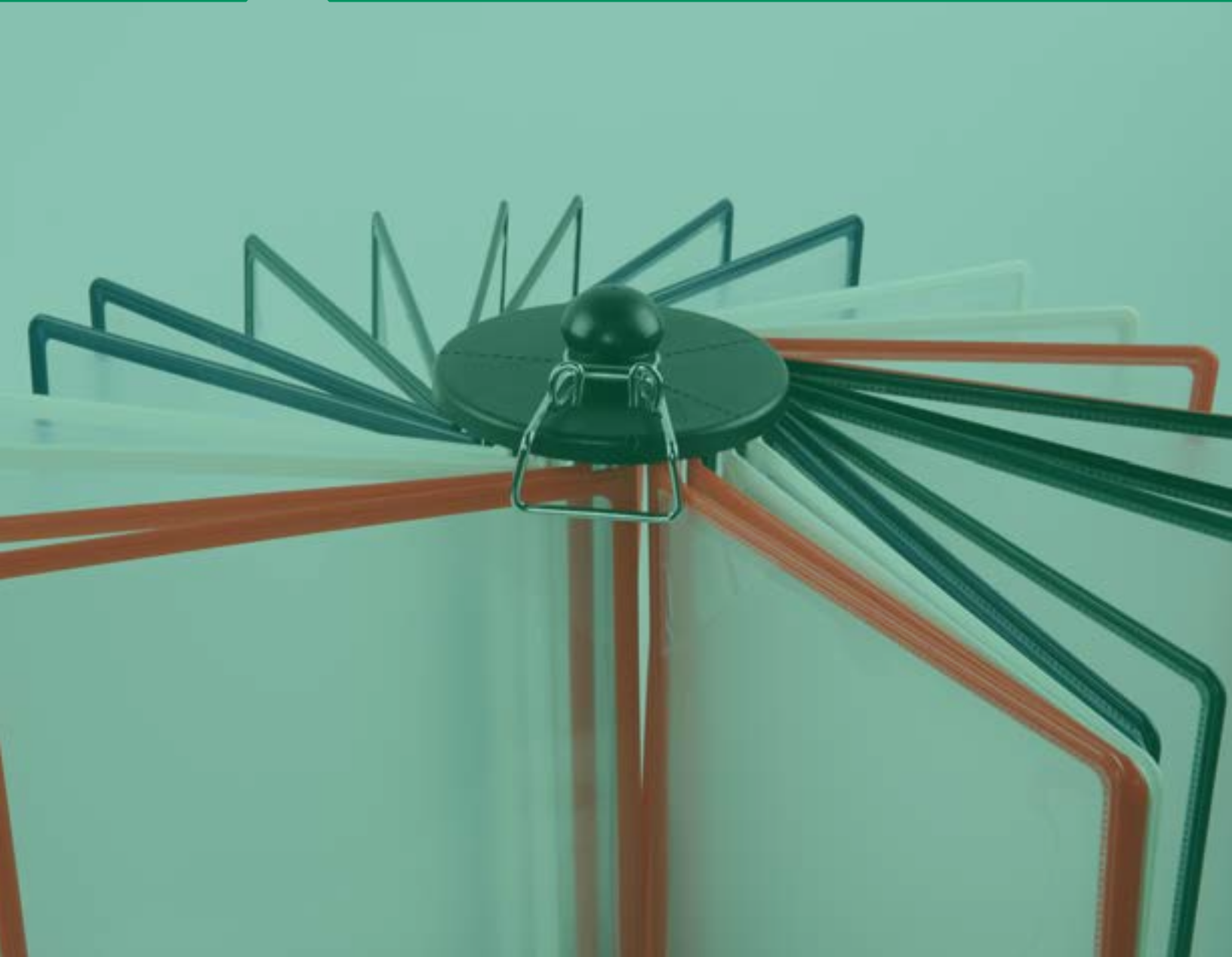

- White Boards
- Map Boards
- Reference Racks
 - Table Top Reference Rack
 - Adjustable Reference Rack System
 - Adjustable Reference Rack with Round Base
 - 360° Rotating Reference Rack
 - Flexible Reference Rack System
 - Wall Mount Reference Rack Plastic
 - Wall Reference Rack
 - Free Standing Reference Rack
 - Floor Standing Reference Rack
- Flipcharts
 - Adjustable Flipchart
 - Reversible Flipchart
 - Mobile Plus Flipchart
 - Professional Mobile Flipchart
- Easels
 - Modern Easel
 - Art Easel
 - Basic Easel **NEW**
 - Portable Easel

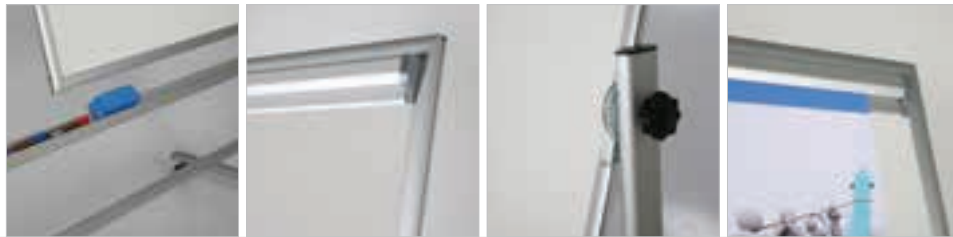

Rotatable Model White Boards Magnetic & Dry Wipe Double Sided



Double sided magnetic drywipe and revolving Whiteboard which offers one side plain smooth surface and the other side allows inserting papers together with drywipe surface. Sturdy Aluminium framed Whiteboards available in large sizes for presentations, training rooms, hanging artworks, maps and charts. The Fast Note on the other side allows inserting various sheets of paper and it is held in place with specially designed rollers. Easy to move the board with locking wheels.

-  For use with drywipe pens. Each board includes a set of magnets.
-  Fast Note is ideal for 0,10-0,80mm thicknesses of materials.
-  Accessories (erase & marker) are not included.

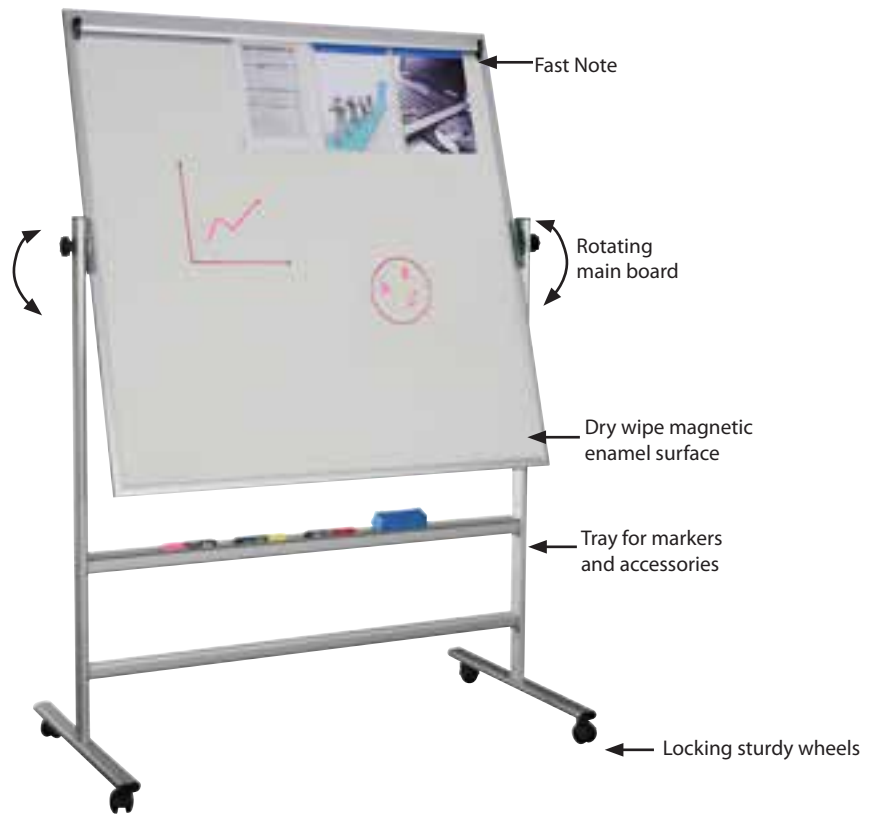

Magnetic Pet Pocket
Please don't forget to order

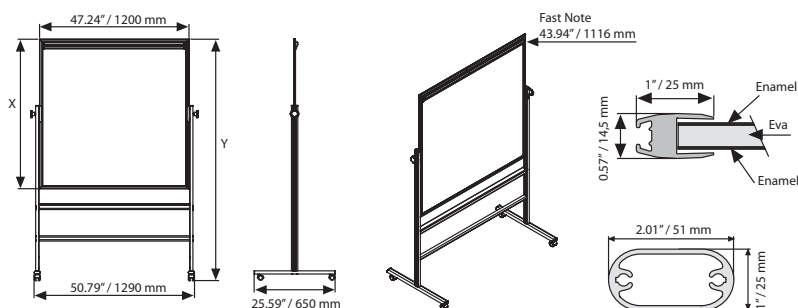

PET POCKET: Magnetic		WEIGHT	PACKING SIZE (10 Pcs)
ARTICLE	DESCRIPTION	WITH PACKING	*W X H X D
UPCMOR00A4	Magnetic 8.5" X 11" Red	0.881 lbs	9.84" X 13.78" X 0.83"
UPCMOB00A4	Magnetic 8.5" X 11" Black	0.881 lbs	9.84" X 13.78" X 0.83"
UPCMOW00A4	Magnetic 8.5" X 11" White	0.881 lbs	9.84" X 13.78" X 0.83"
UPCMOG00A4	Magnetic 8.5" X 11" Gray	0.881 lbs	9.84" X 13.78" X 0.83"

MATERIAL : Clear			WEIGHT	PACKING SIZE
ARTICLE	EXTERNAL (x)	Y	WITH PACKING	*W X H X D
UWBDon1290	35.43"	70.35"	33.289 lbs	11.42" X 12.99" X 7.87"
UWBDon1212	47.24"	76.26"	39.793 lbs	13.39" X 14.17" X 9.06"
UWBDon1215	59.06"	88.07"	48.942 lbs	16.93" X 21.26" X 12.99"

* W:Width H: Height D: Depth





Map Boards

Magnetic & Dry Wipe



Highly durable full colour whiteboard magnetic maps. These detailed and informative maps are framed and encapsulated in a drywipe surface with a magnetic backing board; enabling them to be drawn on or used with magnetic or self adhesive accessories. These multi-functional maps are ideal for sales area planning, campaign management, delivery planning, postal planning, and graphical distributor/ supplier identification. We offer the most popular map types to suit your application; political and geographical. Mounted and framed maps with dry-wipe surface.

 Drywipe surface which accepts magnets. Each board includes a set of free magnets. Supplied ready to wall mount.

 Accessories (eraser&marker) not included.



World Geographical Map

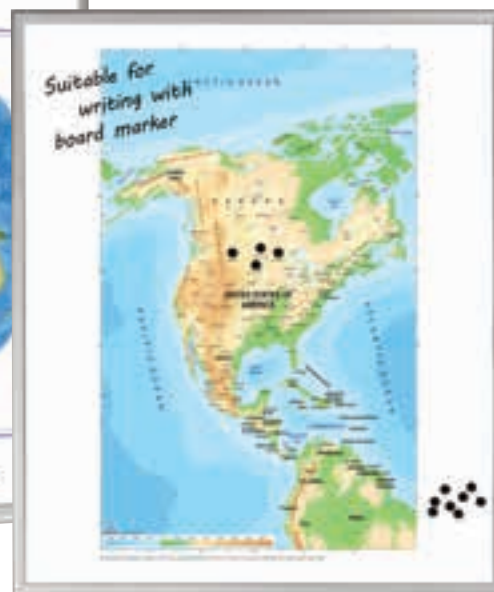

USA Geographical Map



UYTFB00000
Acrylic magnetic tray for board marker.



Magnetic buttons
UYUP397000

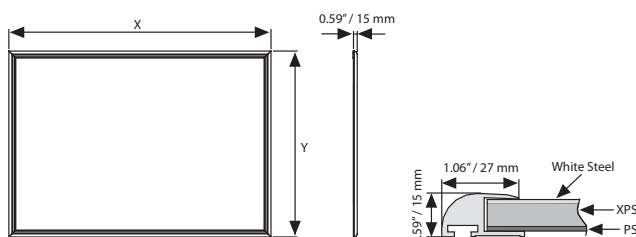

MATERIAL : Silver anodised aluminium				WEIGHT	PACKING SIZE
ARTICLE	EXTERNAL (x-y)	SIZE	DESCRIPTION	WITH PACKING	*W X H X D
UMIFUN1007	40.55" X 28.74"	39.37" X 27.56"	USA Geographical	12.610 lbs	29.92" X 41.73" X 1.22"
UMIFAN1007	40.55" X 28.74"	39.37" X 27.56"	Europe Geographical	12.610 lbs	29.92" X 41.73" X 1.22"
UMIFDN1007	40.55" X 28.74"	39.37" X 27.56"	World Geographical	12.610 lbs	29.92" X 41.73" X 1.22"
UMISUN1007	40.55" X 28.74"	39.37" X 27.56"	USA Political	12.610 lbs	29.92" X 41.73" X 1.22"
UMISAN1007	40.55" X 28.74"	39.37" X 27.56"	Europe Political	12.610 lbs	29.92" X 41.73" X 1.22"
UMISDN1007	40.55" X 28.74"	39.37" X 27.56"	World Political	12.610 lbs	29.92" X 41.73" X 1.22"
UMIFUN1210	48.43" X 40.55"	47.24" X 39.37"	USA Geographical	20.965 lbs	41.73" X 49.61" X 1.22"
UMIFAN1210	48.43" X 40.55"	47.24" X 39.37"	Europe Geographical	20.965 lbs	41.73" X 49.61" X 1.22"
UMIFDN1210	48.43" X 40.55"	47.24" X 39.37"	World Geographical	20.965 lbs	41.73" X 49.61" X 1.22"
UMISUN1210	48.43" X 40.55"	47.24" X 39.37"	USA Political	20.965 lbs	41.73" X 49.61" X 1.22"
UMISAN1210	48.43" X 40.55"	47.24" X 39.37"	Europe Political	20.965 lbs	41.73" X 49.61" X 1.22"
UMISDN1210	48.43" X 40.55"	47.24" X 39.37"	World Political	20.965 lbs	41.73" X 49.61" X 1.22"



* W:Width H: Height D: Depth

Table Top Reference Rack



Steel stand with PET pockets, Table Top Reference Rack allows you to organize busy environments. Do not forget to order pockets separately. Pockets are double sided, allowing you to display 20 pages at a time. The table top reference rack features a black sturdy steel body.

- ! Holds 10 pockets at a time in one rack.
- ! Pockets should be ordered separately.
- ! Pockets available in Red, Black and Grey.

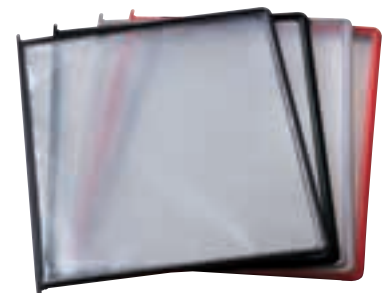

Please don't forget to order.
10 pcs of 1 colour in a box.

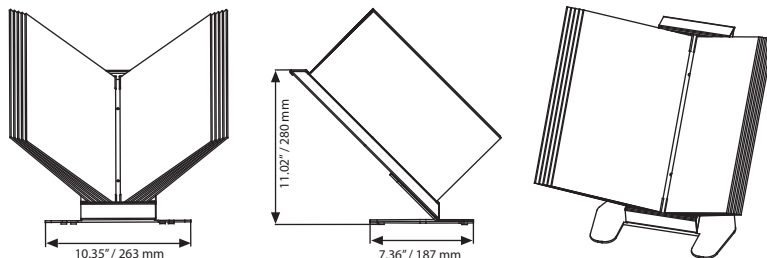

MATERIAL : Silver anodised aluminium			WEIGHT	PACKING SIZE
ARTICLE	PAPER SIZE	DESCRIPTION	WITH PACKING	*W X H X D
URK01N0081	8.5" X 11"	Silver	1.069 lbs	11.42" X 18.90" X 6.30"
URK01B0081	8.5" X 11"	Black	1.069 lbs	11.42" X 18.90" X 6.30"

POSTER POCKET			WEIGHT	PACKING SIZE (10 Pcs)
ARTICLE	PAPER SIZE	DESCRIPTION	WITH PACKING	*W X H X D
TAB0590104	8.5" X 11"	Red	1.212 lbs	15.35" X 21.65" X 23.23"
TAB0590101	8.5" X 11"	Black	1.212 lbs	15.35" X 21.65" X 23.23"
TAB0590109	8.5" X 11"	Grey	1.212 lbs	15.35" X 21.65" X 23.23"

*W:Width H: Height D: Depth





Adjustable Reference Rack System

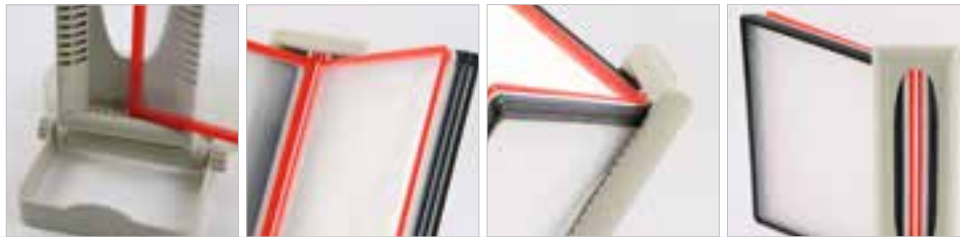

See movie at our website www.mtdisplays.com.tr



Heavy base Adjustable Rack System has capacity of 10 display pockets. It allows adjusting the angle to comfortable eye level. 10 x pockets are included in the system.

-  Holds 10 pockets at a time. Packed unassembled.
-  Sturdy base for a stable and secure unit.
-  Mix colour pockets are included in the pack.

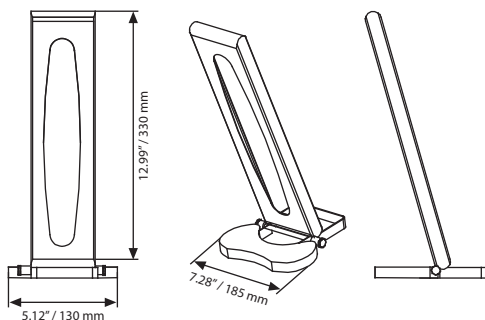

TAB5904003
Tab & Inset. Please don't forget to order.

MATERIAL : Plastic			WEIGHT	PACKING SIZE
ARTICLE	PAPER SIZE	DESCRIPTION	WITH PACKING	*W X H X D
TAB5898002	8.5" X 11"	White	6.062 lbs	4.13" X 15.35" X 10.43"

POSTER POCKET			WEIGHT	PACKING SIZE(10 Pcs)
ARTICLE	PAPER SIZE	DESCRIPTION	WITH PACKING	*W X H X D
TAB0590104	8.5" X 11"	Red	1.212 lbs	15.35" X 21.65" X 23.23"
TAB0590101	8.5" X 11"	Black	1.212 lbs	15.35" X 21.65" X 23.23"
TAB0590109	8.5" X 11"	Grey	1.212 lbs	15.35" X 21.65" X 23.23"

*W:Width H: Height D: Depth



Adjustable Reference Rack with Round Base



See movie at our website www.mtdisplays.com.tr



Adjustable Reference Rack has capacity of 10 display pockets. It has a decorative round base in beige colour which may also serve as organizer for self-stick notes. The pockets are included in the pack index tab & insets should be ordered separately.

 Holds 10 pockets at a time in one rack.

 Pockets should be ordered separately. Pockets available in Red, Black and Grey.

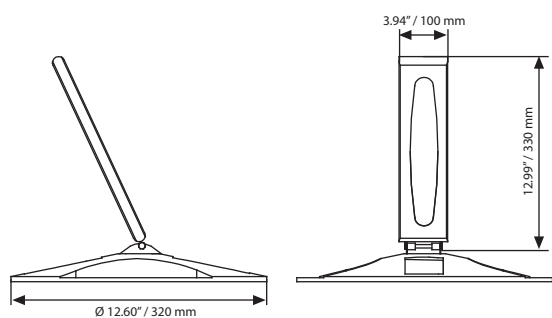

MATERIAL : Plastic			WEIGHT	PACKING SIZE
ARTICLE	PAPER SIZE	DESCRIPTION	WITH PACKING	*W X H X D
TAB5869002	8.5" X 11"	White	3.571 lbs	5.31" X 15.35" X 12.80"
POSTER POCKET			WEIGHT	PACKING SIZE(10 Pcs)
ARTICLE	PAPER SIZE	DESCRIPTION	WITH PACKING	*W X H X D
TAB0590104	8.5" X 11"	Red	1.212 lbs	15.35" X 21.65" X 23.23"
TAB0590101	8.5" X 11"	Black	1.212 lbs	15.35" X 21.65" X 23.23"
TAB0590109	8.5" X 11"	Grey	1.212 lbs	15.35" X 21.65" X 23.23"

*W:Width H: Height D: Depth





360° Rotating Reference Rack



See movie at our website www.mtdisplays.com.tr



360° rotating tabletop reference rack has capacity of 50 display pockets. Pockets and index tabs & insets should be ordered separately. Suitable for places where various information is needed.

-  Holds 50 pockets at a time. Packed unassembled.
-  Sturdy base for a stable and secure unit.
-  Pockets should be ordered separately. Pockets available in Red, Black and Grey.

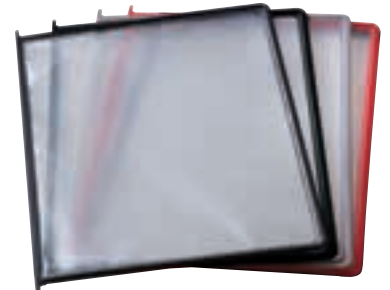
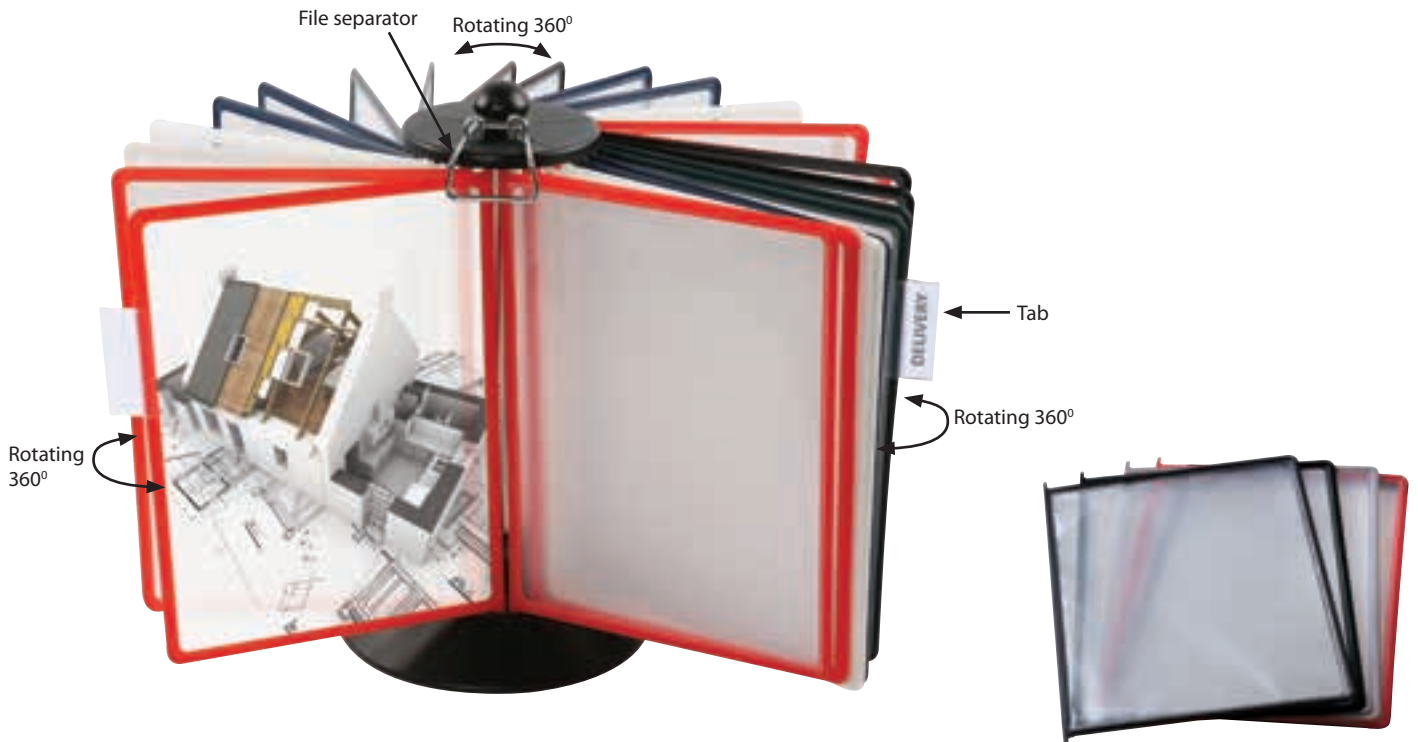

Please don't forget to order. 10 pcs of 1 colour in a box.



Red Black Grey

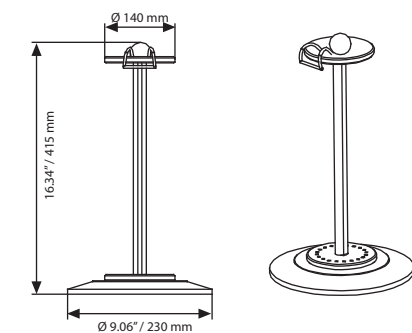

TAB5904003
Tab & Inset. Please don't forget to order.

MATERIAL : Plastic			WEIGHT	PACKING SIZE
ARTICLE	PAPER SIZE	DESCRIPTION	WITH PACKING	*W X H X D
TAB5896001	8.5" X 11"	Black	5.776 lbs	10.43" X 16.54" X 10.43"

POSTER POCKET			WEIGHT	PACKING SIZE(10 Pcs)
ARTICLE	PAPER SIZE	DESCRIPTION	WITH PACKING	*W X H X D
TAB0590104	8.5" X 11"	Red	1.212 lbs	15.35" X 21.65" X 23.23"
TAB0590101	8.5" X 11"	Black	1.212 lbs	15.35" X 21.65" X 23.23"
TAB0590109	8.5" X 11"	Grey	1.212 lbs	15.35" X 21.65" X 23.23"

*W:Width H: Height D: Depth



Flexible Reference Rack System



See movie at our website www.mtdisplays.com.tr



This Reference Rack System is flexible in every means. It can rotate 360 round, height can be adjusted up to 13.98" and the reading angle is adjustable as required. 10 pockets are included in the pack to displays 20 pages at a time.

 Holds 10 pockets at a time in one rack.

 Mix colour pockets are included in the pack.

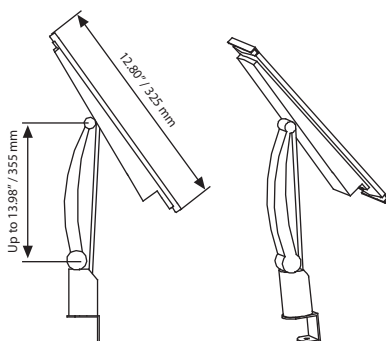
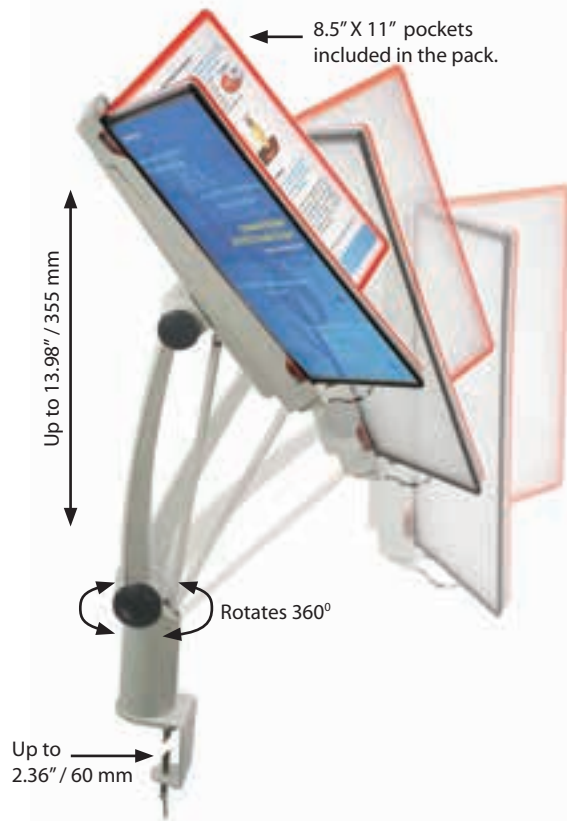

TAB5904003
Tab & Inset. Please don't forget to order.

MATERIAL : Plastic			WEIGHT	PACKING SIZE
ARTICLE	PAPER SIZE	DESCRIPTION	WITH PACKING	*W X H X D
TAB5846002	8.5" X 11"	White	4.960 lbs	6.10" X 18.90" X 10.43"
POSTER POCKET			WEIGHT	PACKING SIZE(10 Pcs)
ARTICLE	PAPER SIZE	DESCRIPTION	WITH PACKING	*W X H X D
TAB0590104	8.5" X 11"	Red	1.212 lbs	15.35" X 21.65" X 23.23"
TAB0590101	8.5" X 11"	Black	1.212 lbs	15.35" X 21.65" X 23.23"
TAB0590109	8.5" X 11"	Grey	1.212 lbs	15.35" X 21.65" X 23.23"



* W:Width H: Height D: Depth



Wall Mount Reference Rack Plastic & Steel



Plastic stand with PET pockets, Reference Rack for Wall can be fixed to required height. Wall fixing components and pockets are included in the pack. Light weight, this products is suitable for diffrent office enviroment when space is limited. 10 pockets are included in the pack to displays 20 pages at a time.

-  Holds 10 pockets at a time. Packed unassembled.
-  Sturdy base for a stable and secure unit.
-  Mix colour pockets are included in the pack.

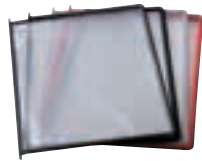

Pockets in 3 colours
Each colour boxed in 10 pcs.
Please don't forget to order.

  
Red Black Grey

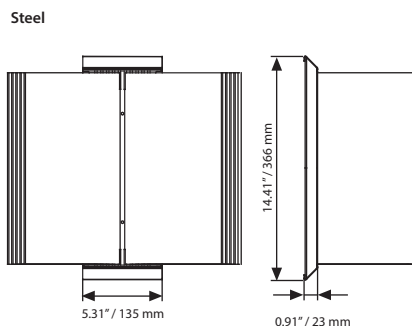
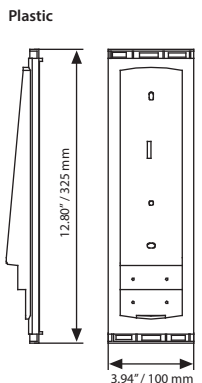

TAB5904003
Tab & Inset.
Please don't forget to order.

POSTER POCKET			WEIGHT	PACKING SIZE (10 Pcs)
ARTICLE	PAPER SIZE	DESCRIPTION	WITH PACKING	*W X H X D
TAB0590104	8.5" X 11"	Red	1.212 lbs	15.35" X 21.65" X 23.23"
TAB0590101	8.5" X 11"	Black	1.212 lbs	15.35" X 21.65" X 23.23"
TAB0590109	8.5" X 11"	Grey	1.212 lbs	15.35" X 21.65" X 23.23"



*W:Width H: Height D: Depth

MATERIAL : Silver anodised aluminium			WEIGHT	PACKING SIZE
ARTICLE	PAPER SIZE	DESCRIPTION	WITH PACKING	*W X H X D
URK03N0081	8.5" X 11"	Silver	1.102 lbs	6.30" X 16.54" X 1.22"
URK03B0081	8.5" X 11"	Black	1.102 lbs	6.30" X 16.54" X 1.22"



*W:Width H: Height D: Depth

MATERIAL : Plastic			WEIGHT	PACKING SIZE
ARTICLE	PAPER SIZE	DESCRIPTION	WITH PACKING	*W X H X D
TAB5936002	8.5" X 11"	White	2.204 lbs	3.74" X 14.96" X 10.43"



*W:Width H: Height D: Depth

Free Standing Reference Rack



Sturdy aluminum pole with double channels.
 Each pocket displays 2 brochures. Pockets flip easily.
 Do not forget to order pockets separately.
 Hold 10 pockets at the a time. Allows extra frame and brochure holders to add on when need be.

- Holds 10 pockets at a time. Packed unassembled.
- Sturdy base for a stable and secure unit.
- Pockets should be ordered seperately. Pockets available in Red, Black and Grey.
- 4 packs. See info chart for pack sizes.

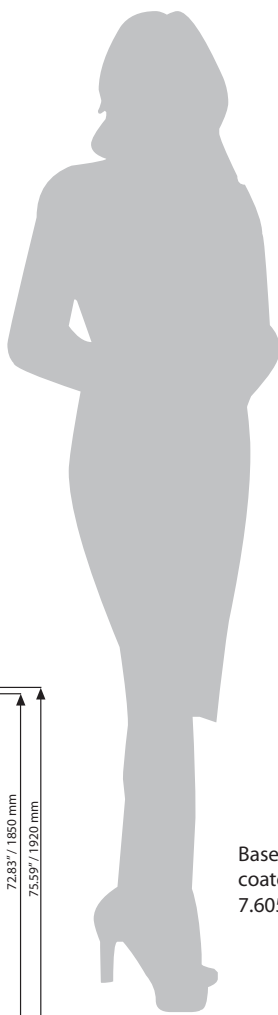

Snap open

11" X 17" poster size

Allows extra brochure holder on the pole

Base powder coated RAL 9006, 7.605 lbs



Please don't forget to order pockets.

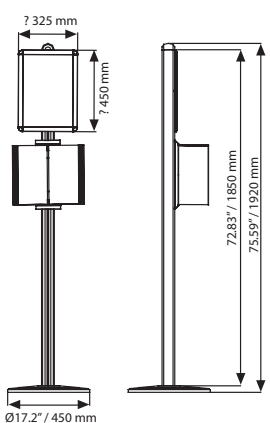

MATERIAL : Silver anodised aluminium			WEIGHT	PACKING SIZE
ARTICLE	PAPER SIZE	DESCRIPTION	WITH PACKING	*W X H X D
URK04N0081	8.5" X 11"	Silver	30.864 lbs	3.54" X 76.77" X 3.74" / 18.90" X 18.90" X 1.97"
				18.11" X 25.98" X 0.83" / 6.30" X 16.54" X 1.22"
URK04B0081	8.5" X 11"	Black	30.864 lbs	3.54" X 76.77" X 3.74" / 18.90" X 18.90" X 1.97"
				18.11" X 25.98" X 0.83" / 6.30" X 16.54" X 1.22"

POSTER POCKET			WEIGHT	PACKING SIZE(10 Pcs)
ARTICLE	PAPER SIZE	DESCRIPTION	WITH PACKING	*W X H X D
TAB0590104	8.5" X 11"	Red	1.212 lbs	15.35" X 21.65" X 23.23"
TAB0590101	8.5" X 11"	Black	1.212 lbs	15.35" X 21.65" X 23.23"
TAB0590109	8.5" X 11"	Grey	1.212 lbs	15.35" X 21.65" X 23.23"





*W:Width H: Height D: Depth



Floor Standing Reference Rack



Steel stand with PET pockets, Table Top Reference allows you to organize busy environments. Pole constructed heavy aluminium extrusion. Each pocket displays 2 brochures. Pockets flip easily. Do not forget to order pockets separately. Holds 10 pockets at a time allowing to display 20 pages.

-  Holds 10 pockets at a time. Packed unassembled.
-  Sturdy base for a stable and secure unit.
-  Pockets should be ordered separately. Pockets available in Red, Black and Grey.
-  3 packs. See info chart for pack sizes.

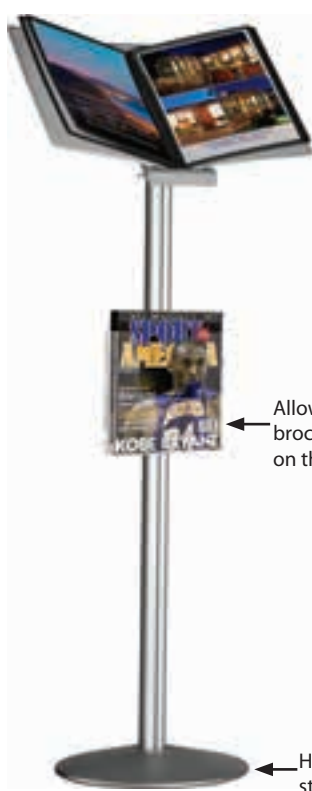

Allows extra brochure holder on the pole

Base powder coated RAL 9006, 7.605 lbs.

Heavy sturdy base



Please don't forget to order pockets.

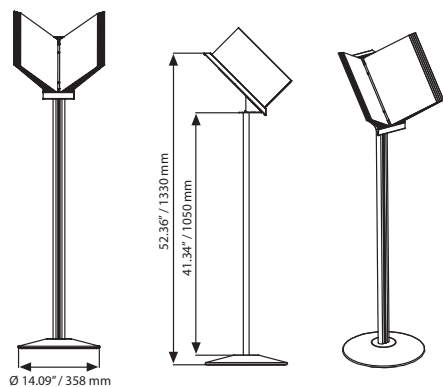

MATERIAL : Silver anodised aluminium			WEIGHT	PACKING SIZE
ARTICLE	PAPER SIZE	DESCRIPTION	WITH PACKING	*W X H X D
URK05N0081	8.5" X 11"	Silver Rack	20.282 lbs	2.76" X 44.09" X 1.57" / 14.96" X 15.35" X 1.97"
				6.30" X 16.54" X 4.33"
URK05B0081	8.5" X 11"	Black Rack	20.282 lbs	2.76" X 44.09" X 1.57" / 14.96" X 15.35" X 1.97"
				6.30" X 16.54" X 4.33"

POSTER POCKET			WEIGHT	PACKING SIZE(10 Pcs)
ARTICLE	PAPER SIZE	DESCRIPTION	WITH PACKING	*W X H X D
TAB0590104	8.5" X 11"	Red	1.212 lbs	15.35" X 21.65" X 23.23"
TAB0590101	8.5" X 11"	Black	1.212 lbs	15.35" X 21.65" X 23.23"
TAB0590109	8.5" X 11"	Grey	1.212 lbs	15.35" X 21.65" X 23.23"

* W:Width H: Height D: Depth



Adjustable Flipchart & Reversible Flipchart



Made of Steel and aluminium, single sided Adjustable Flipchart has whiteboard surface which is both magnetic and drywipe. Important messages, tables, charts can be clipped with magnets. Alternatively large papers can be clipped or drywipe surface can be written for more interactive meetings or presentations. Foldable pen tray stores the pens, eraser or some other accessories. Height is easily adjusted to max 1850mm. Powder coated tripod legs provide stability to Adjustable Flipchart. Soft corners and rubber feet allow using in schools as well any commercial or office environments.

 A magnetic eraser and 3 magnets are supplied in the pack.

 Drawing pads and pen not included. Protective film over magnetic surface should be removed before use.

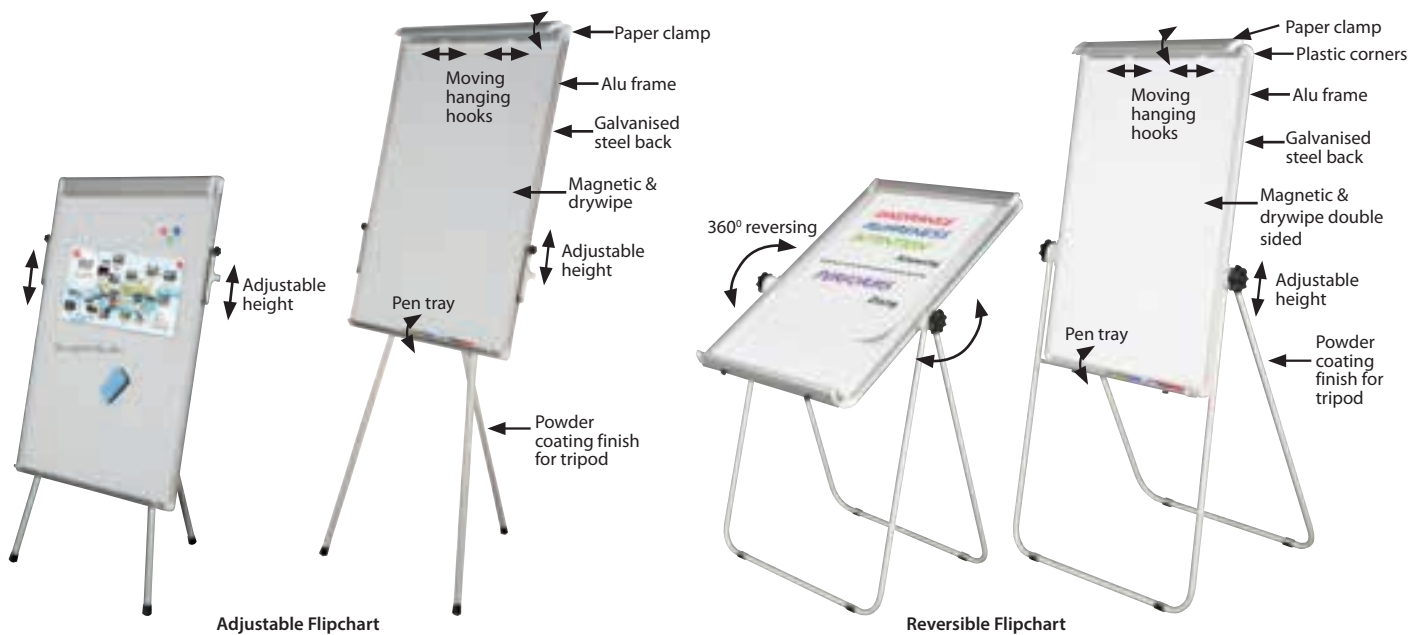

Adjustable Flipchart

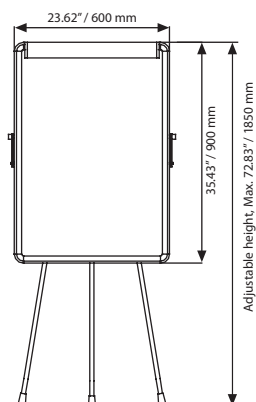

Reversible Flipchart

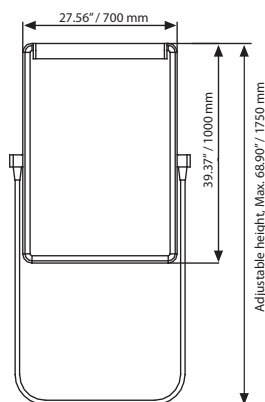

Magnetic buttons included.



Magnetic Eraser included.

MATERIAL: Steel & aluminium					WEIGHT	PACKING SIZE
ARTICLE	BOARD SIZE	WRITABLE AREA	COLOUR	DESCRIPTION	WITH PACKING	*W X H X D
TWYFC33301	23.62" X 35.43"	21.26" X 31.69"	White	Adjustable Flipchart	15.873 lbs	26.57" X 42.91" X 2.95"
TWYFC66601	27.56" X 39.37"	25.20" X 35.63"	White	Reversible Flipchart	21.384 lbs	32.48" X 45.08" X 2.95"

*W:Width H: Height D: Depth



Modern Easel



See movie at our website www.mtdisplays.com.tr



Made of Beechwood, Easel is a solid product for commercial use. Adjustable easel accommodates varying canvas sizes. It is made to be sturdy, strong, and will last in retail settings. Adjustable back support ensures stability of the easel and comfortable use at different angles. It folds flat for easy storage.



It holds frames from B2 up to A0.



Please order the accessories separately.

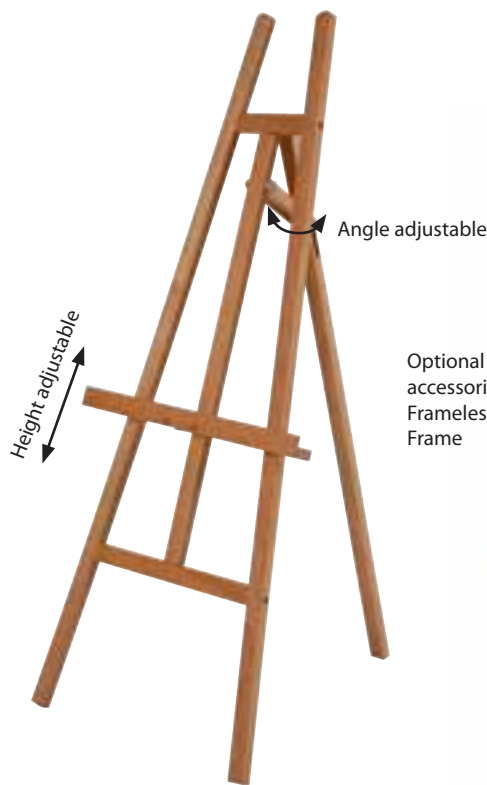

Optional accessories
Frameless
Frame



Optional Accessories

- Opti Frame see page 17-18
- Snap Frame see page 24
- Magnetic Glassboard see page 179
- Easy Wood Frame see page 134
- Frameless Frame see page 134
- Frameboard 9 mm see page 178

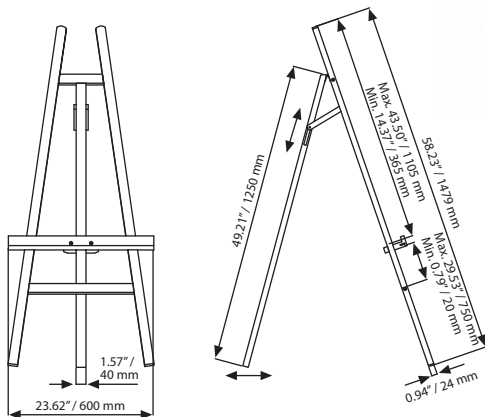

Don't forget to order
Chalkboard Marker
UYAKLM1251 - Colour Marker
UYAKLM1250 - White Marker

MATERIAL: Beech Wood		WEIGHT	PACKING SIZE
ARTICLE	SIZE	WITH PACKING	*W X H X D
USLM000015	23.62" X 31.10" X 58.27"	11.023 lbs	4.53" X 60.24" X 2.95"

* W:Width H: Height D: Depth



Art Easel



Made of Beechwood, Easel is a solid product for commercial use. Adjustable easel accommodates varying canvas sizes. It is made to be sturdy, strong, and will last in retail settings. Adjustable back support ensures stability of the easel and comfortable use at different angles. It folds flat for easy storage.



It holds frames from B2 up to A0.



Please order the accessories separately.

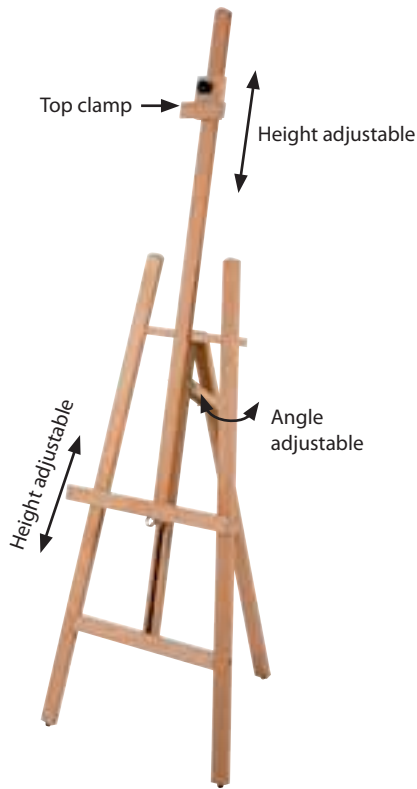

Optional accessories
Magnetic
Glassboard



Optional Accessories

- Opti Frame see page 17-18
- Snap Frame see page 24
- Magnetic Glassboard see page 179
- Easy Wood Frame see page 134
- Frameless Frame see page 134
- Frameboard 9 mm see page 178

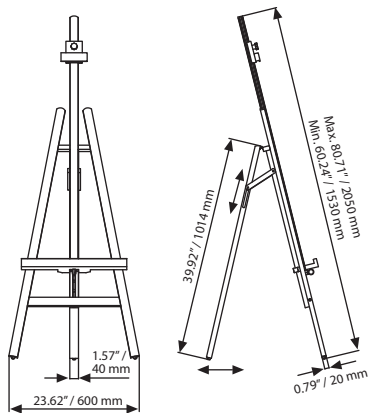

Don't forget to order
Chalkboard Marker
UYAKLM1251 - Colour Marker
UYAKLM1250 - White Marker

MATERIAL: Beech Wood		WEIGHT	PACKING SIZE
ARTICLE	SIZE	WITH PACKING	*W X H X D
USLA000012	23.62" X 21.65" X 60.24"	12.125 lbs	5.31" X 48.82" X 3.35"

*W:Width H: Height D: Depth



Basic Easel

new



See movie at our website www.mtdisplays.com.tr

Basic Easel is made of Pine wood which is one of the most strongest woods used for furniture. Basic Easel is an economic solution for many type of business. Height adjustable easel accommodates varying canvas sizes. It is made to be sturdy, strong, and will last in retail settings. Adjustable back support and chain ensures stability of the easel and comfortable use at different angles. It folds flat for easy storage.

It holds frames from B2 up to A0.

Please order the accessories separately.

Assembly in 10 seconds.



Optional Accessories

- Opti Frame see page 17-18
- Snap Frame see page 24
- Magnetic Glassboard see page 179
- Easy Wood Frame see page 134
- Frameless Frame see page 134
- Frameboard 9 mm see page 178

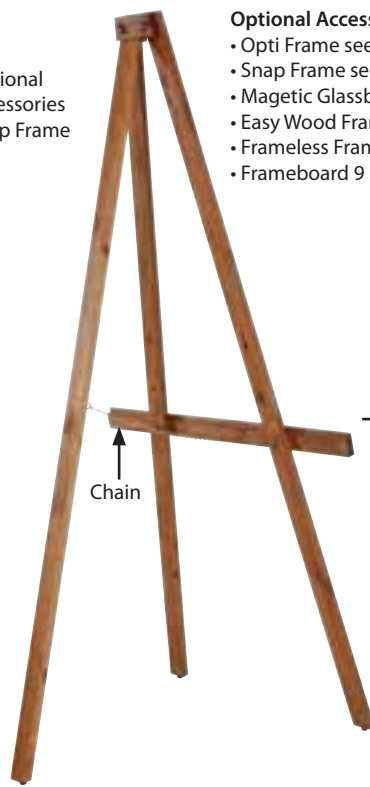

3 different display height

Pine wood

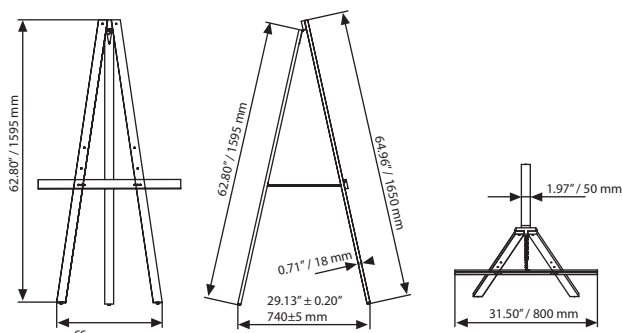
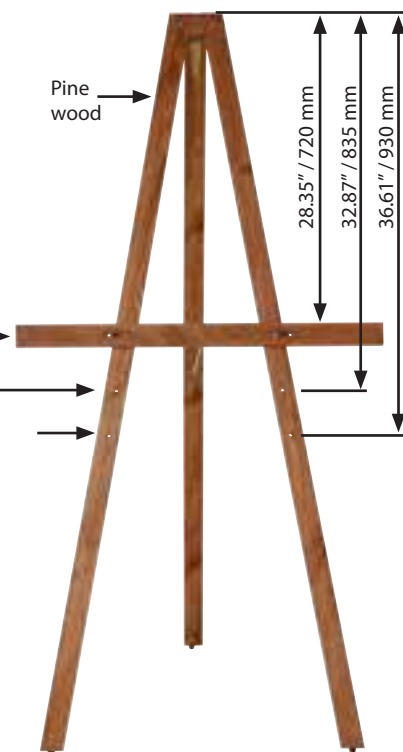

Don't forget to order
Chalkboard Marker
UYAKLM1251 - Colour Marker
UYAKLM1250 - White Marker

MATERIAL : Pine wood			WEIGHT	PACKING SIZE
ARTICLE	SIZE (x-y)	DESCRIPTION	WITH PACKING	*W X H X D
USLBN00016	23.43" X 29.13"	Natural Wood	11.023 lbs	6.10" X 67.72" X 3.15"
USLBD00016	23.43" X 29.13"	Dark Wood	11.023 lbs	6.10" X 67.72" X 3.15"

*W:Width H: Height D: Depth



Portable Easel

new



See movie at our website www.mtdisplays.com.tr

Portable Easel is made of aluminium and steel, it is durable and suitable for various environments. Textured black finish gives smart look for Portable Easel. 5 different positions allow displaying various sizes of frames. Foldable feet helps transporting and storing. Simply spread the two legs apart, and the unit is ready for use. Suitable for restaurants, boutiques, art galleries, classrooms or more.

It holds frames from 22"x28" up to 36"x48"

No tool assembly.

Packed unassembled with an easy to understand instructions.

Color options : Silver-anodized & black

Optional Accessories

- Opti Frame see page 17-18
- Snap Frame see page 24
- Magnetic Glassboard see page 179
- Easy Wood Frame see page 134
- Frameless Frame see page 134
- Frameboard 9 mm see page 178

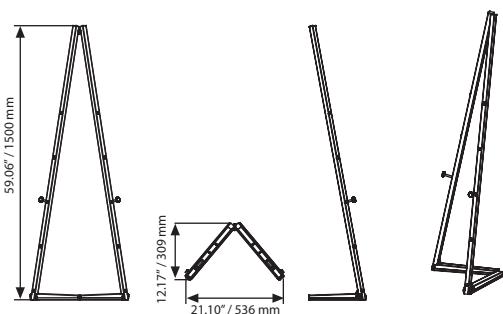
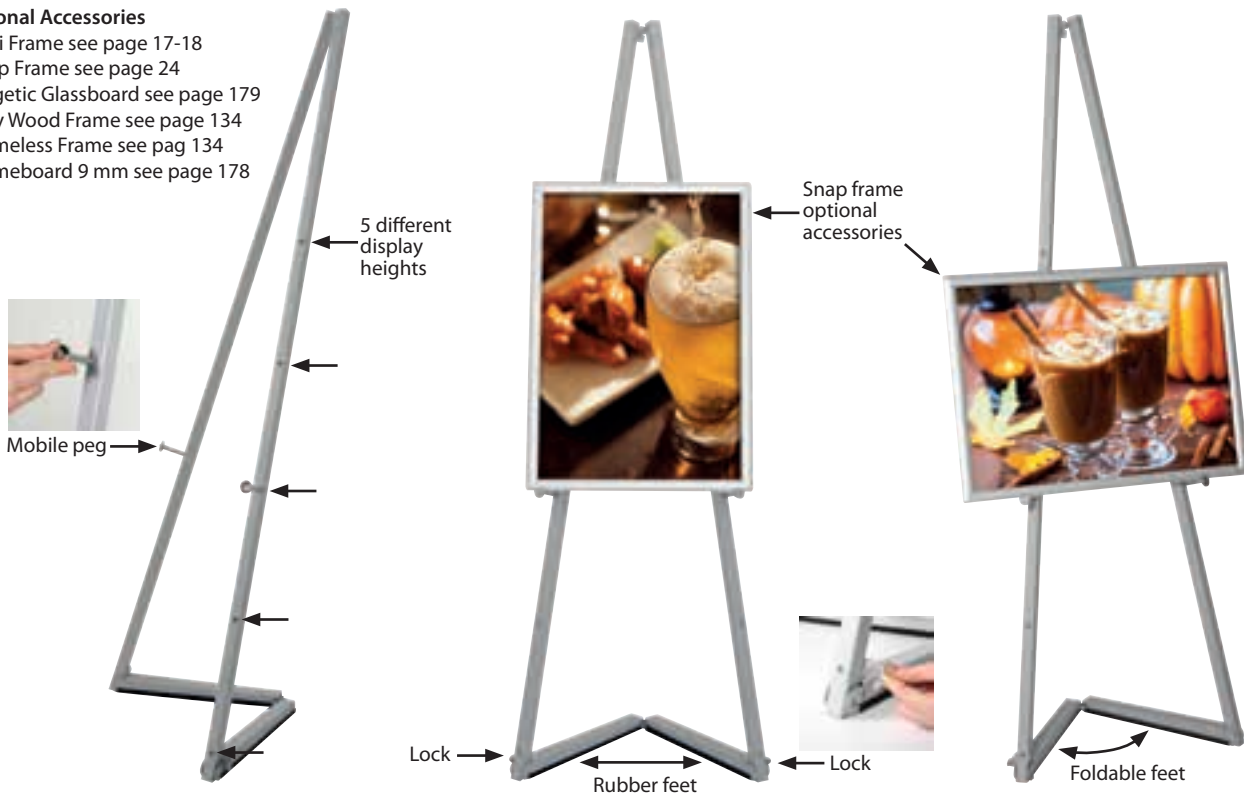

MATERIAL: Steel			WEIGHT	PACKING SIZE
ARTICLE	SIZE	DESCRIPTION	WITH PACKING	*W X H X D
UPESLOG015	59.06" X 21.10" X 12.17"	Gray	10.031 lbs	3.94" X 61.81" X 1.97"
UPESLOB015	59.06" X 21.10" X 12.17"	Black	10.031 lbs	3.94" X 61.81" X 1.97"

*W:Width H: Height D: Depth





Tablet & TV Stands

- Slim TV Stand
- Smart TV Stand
- Counter Tablet Holders
 - Semi Circle Tablet Holder
 - Gray Tripod Tablet Holder
 - Hook Tablet Holder
 - Pocket Tablet Holder
 - Peek Tablet Holder
 - Moon Tablet Holder
 - Turret Tablet Holder
 - Pyramid Tablet Holder
 - Universal Desktop Tablet Kiosk
- Tablet Kiosk
 - Universal Curved Tablet Kiosk
 - Universal Flexible Tablet Kiosk
 - Universal Novel Tablet Kiosk
 - Universal Novel Tablet Kiosk for Wall & Freestanding
- Boomerang Floor Tablet Stand
- Spider Floor Tablet Stand
- Red Spider Floor Tablet Stand





Slim TV Stand



Slim TV stand is a portable stand which is easy to move room-to-room for any reason. It is designed to hold flat-screen monitors between 30" and 50" that weigh less than 156lbs. The VESA-compatible bracket fits most brand names and models

Slim TV stand with wheels includes a 15.75 inch-wide shelf that can be positioned at 3 different levels along the floor-standing fixture for presentation accessories. The stand itself is also height adjustable, with 8 set heights at which a monitor may be positioned. This black rolling TV stand is equipped with locking wheels for easy movement. It provides comfortable use by adjusting the screen height and angle . Suitable to use in all places where space is limited.

 Suitable for screens 30" up to 50" and can carry up to 132lbs/59kg.

 Castored wheels.

 Easy mounting sheets enclosed.

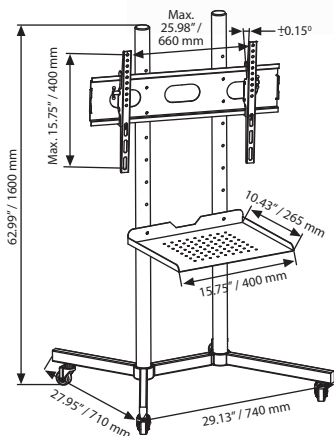

MATERIAL : Black anodised aluminium		WEIGHT	PACKING SIZE
ARTICLE	DESCRIPTION	WITH PACKING	*W X H X D
UTVS10B000	Black	14,000 kg	430 X 730 X 65 mm - 120 X 147 X 65 mm



*W:Width H: Height D: Depth

Smart TV Stand





See movie at our website www.mtdisplays.com.tr



This contemporary and easy use TV stand is suitable for modern offices and exhibitions where space is limited. It allows adjusting the screen height and angle for comfortable use. It is complete with height adjustable shelf.

 Suitable for screens 30" up to 50" and can carry up to 132lbs/59kg.

 Castored wheels.

 Easy mounting sheets enclosed.

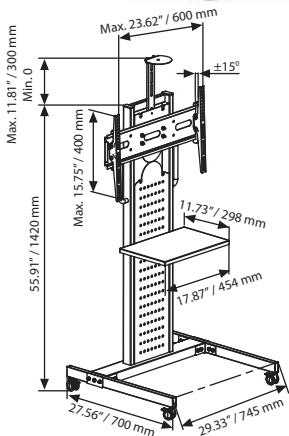

MATERIAL : Black anodised aluminium		WEIGHT	PACKING SIZE
ARTICLE	DESCRIPTION	WITH PACKING	*W X H X D
UTVS20B000	Black		



*W:Width H: Height D: Depth

Tablet Holders

Wide selection of tablet holders is suitable for most tablets, smart phones and laptops both in landscape and portrait positions. They designed for ergonomic use, adjustable and with soft edges to protect furniture from scratches.



Semi Circle Tablet Holder



Color options :
Silver-anodized & black.

MATERIAL : ABS Plastic		WEIGHT	PACKING SIZE
ARTICLE	DESCRIPTION	WITH PACKING	*W X H X D
TGRIA30301	Black	0.992 lbs	8.27" X 11.81" X 1.38"
TGRIA30309	Silver	0.992 lbs	8.27" X 11.81" X 1.38"



*W:Width H:Height D:Depth

Gray Tripod Tablet Holder



MATERIAL :		WEIGHT	PACKING SIZE
ARTICLE	DESCRIPTION	WITH PACKING	*W X H X D
TLCPO22009	Silver	1.781 lbs	9.84" X 9.06" X 5.71"



*W:Width H:Height D:Depth

Hook Tablet Holder

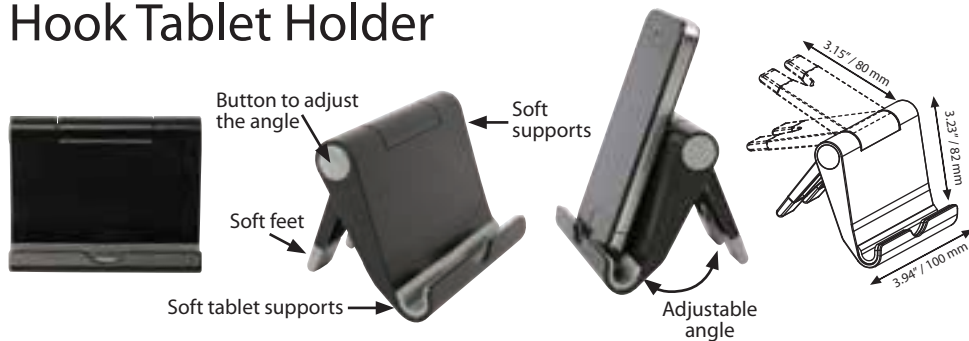

MATERIAL : ABS Plastic		WEIGHT	PACKING SIZE
ARTICLE	DESCRIPTION	WITH PACKING	*W X H X D
TGRID10201	Black	0.242 lbs	3.54" X 4.33" X 1.38"



*W:Width H:Height D:Depth

Pocket Tablet Holder



MATERIAL : ABS & Aluminium		WEIGHT	PACKING SIZE
ARTICLE	DESCRIPTION	WITH PACKING	*W X H X D
TGRID10301	Black	0.496 lbs	5.51" X 8.27" X 1.77"



*W:Width H:Height D:Depth

Peak Tablet Holder

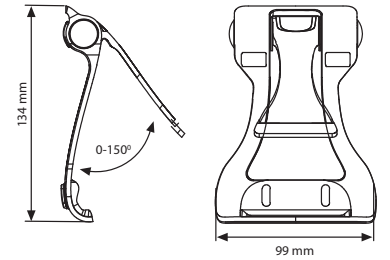

MATERIAL : ABS Plastic		WEIGHT	PACKING SIZE
ARTICLE	DESCRIPTION	WITH PACKING	*W X H X D
TLCPO36003	White-Pink	0.665 lbs	4.13" X 5.71" X 1.18"
TLCPO37009	Silver	1.091 lbs	4.13" X 5.71" X 1.18"

*W:Width H: Height D: Depth

TP 2 YEAR WARRANTY

Moon Tablet Holder

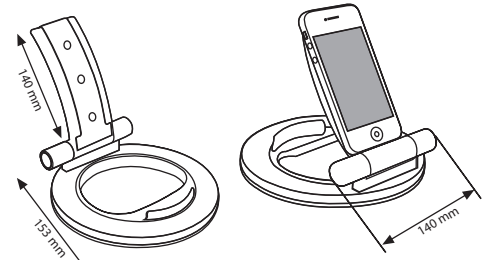

MATERIAL : ABS PLASTIC		WEIGHT	PACKING SIZE
ARTICLE	DESCRIPTION	WITH PACKING	*W X H X D
TGRID10403	WHITE	0.524 lbs	6.69" X 6.69" X 1.97"

*W:Width H: Height D: Depth

TP 2 YEAR WARRANTY

Turret Tablet Holder

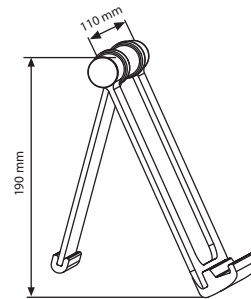

MATERIAL : ABS Plastic		WEIGHT	PACKING SIZE
ARTICLE	DESCRIPTION	WITH PACKING	*W X H X D
TLCPO08009	Silver	0.661 lbs	5.71" X 9.06" X 1.77"

*W:Width H: Height D: Depth

TP 2 YEAR WARRANTY

Pyramid Tablet Holder



One product, two positions (landscape & portrait)

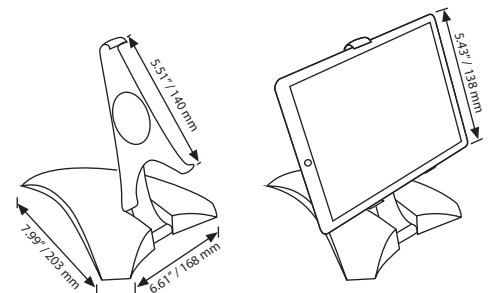

MATERIAL : ABS Plastic		WEIGHT	PACKING SIZE
ARTICLE	DESCRIPTION	WITH PACKING	*W X H X D
TFRIA30303	White	1.091 lbs	7.87" X 9.84" X 2.36"

*W:Width H: Height D: Depth

TP 2 YEAR WARRANTY

Universal Desktop Tablet Kiosk



See movie at our website www.mtdisplays.com.tr



Smart Solutions for Technological Devices! Desktop universal tablet stand offers smart solutions for introductions or presentations in offices or commercial environments. It is suitable for iPad1, 2, 3, 4, Air, Samsung Galaxy and most 9.7"-10.1" tablets. The tablet holder can be rotated to display landscape portrait positions and tablet is secured with a lockable case to reduce the risk of theft. The home button is covered to prevent interfering from the public. It is already inclined at a convenient fixed reading angle.



Packed assembled.



USB cable is not included. Order separately. Fixing for floor mounting included.



Closed home button.

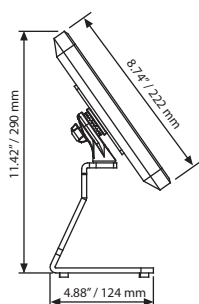
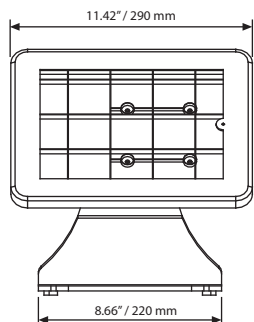

MATERIAL : Steel & acrylic		WEIGHT	PACKING SIZE
ARTICLE	DESCRIPTION	WITH PACKING	*W X H X D
UUTMOB1B00	Black	2.755 lbs	12.80" X 9.45" X 5.12"



*W:Width H: Height D: Depth



Universal Curved Tablet Kiosk



See movie at our website www.mtdisplays.com.tr



Smart Solutions for Technological Devices! With sleek design and matt finish, Universal Curved Tablet Kiosk captures customers' attention in all traffic areas. Universal Curved Tablet Kiosk is suitable for iPad1, 2, 3, 4, Air, Samsung Galaxy and most 9.7"-10.1" tablets. The tablet holder can be rotated to display landscape portrait positions and tablet is secured with a lockable case to reduce the risk of theft. The home button is covered to prevent interfering from the public. Universal Curved iPad Kiosk is suitable for retail purposes, trade shows and conventions as well as car galleries, furniture stores when the base is adjusted. It has a complete style with black cover and cable travelling through the pole.

-  Packed unassembled with an easy to understand instruction for assembly.
-  USB cable is not included. Order separately. Fixing for floor mounting included.
-  Closed home button.



Don't forget to order USB cable.

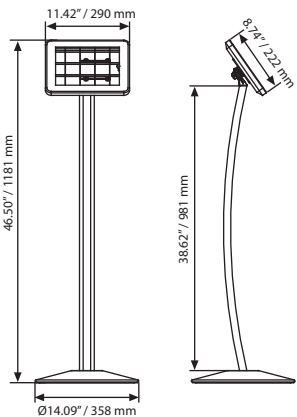

TZZZ998701
Cable lock kit for iPad 82.68"



TSTDIC1450B
Cable for all iPhones & iPads.



TSTDICP40B
Cable for iPhone 4S, iPad 3 and earlier.



TSTDICP50B
Cable for iPhone 5, iPad 4 and later.



TSTDICV80B
Cable V8, micro USB for Samsung, LG etc...



UYPPD0000
Lightning to 30-pin adapter. Packed by 10 pcs. You can use all type of Kiosk for iPad 4 too.

MATERIAL : Black anodised aluminium		WEIGHT	PACKING SIZE
ARTICLE	DESCRIPTION	WITH PACKING	*W X H X D
UUTC0B1B00	Black	10.758 lbs	18.50" X 43.70" X 2.64"

*W:Width H:Height D:Depth



Universal Flexible Tablet Kiosk



See movie at our website www.mtdisplays.com.tr



It is a genuine design for today's technological display solutions. The tablet holder can be rotated to display landscape portrait positions and adjusted to at a required reading angle. The height of the kiosk can be adjusted to max 1220mm. when landscape and max 1245mm when portrait. Universal Flexible Tablet Kiosk is suitable for iPad1, 2, 3, 4, Air, Samsung Galaxy and most 9.7"-10.1" tablets. The tablet holder can be rotated to display landscape portrait positions and tablet is secured with a lockable case to reduce the risk of theft. The home button is covered to prevent interfering from the public. Universal Curved iPad Kiosk is suitable for retail purposes, trade shows and conventions as well as car galleries, furniture stores when the base is adjusted.

- Packed unassembled with an easy to understand instruction for assembly.
- USB cable is not included. Order separately. Fixing for floor mounting included.
- Closed home button.

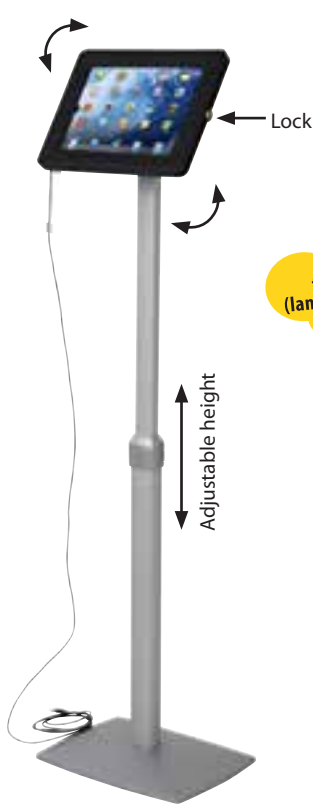

One product, two positions (landscape & portrait)

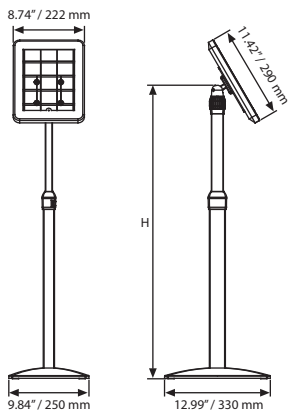
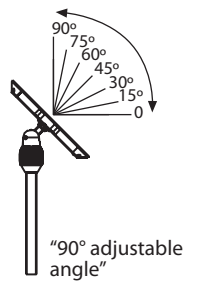
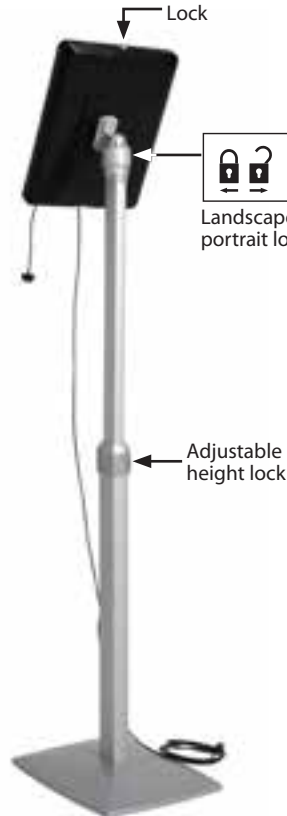
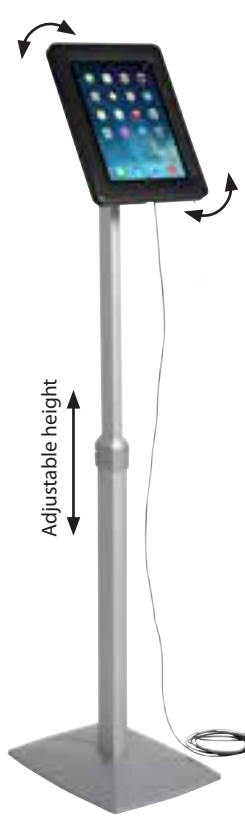

Don't forget to order USB cable.



TZZ998701
Cable lock kit for iPad 82.68"



TSTDIC450B
Cable for all iPhones & iPads.



TSTDICP40B
Cable for iPhone 4S, iPad 3 and earlier.



TSTDICP50B
Cable for iPhone 5, iPad 4 and later.



TSTDCV80B
Cable V8, micro USB for Samsung, LG etc...



UYPPD0000
Lightning to 30-pin adapter. Packed by 10 pcs. You can use all type of Kiosk for iPad 4 too.

MATERIAL : Silver anodised aluminium			WEIGHT	PACKING SIZE
ARTICLE	Height Max.	Height Min.	WITH PACKING	*W X H X D
UUTFON0B00	43.11"	30.91"	11.243 lbs	11.22" X 41.73" X 4.21"

* W:Width H:Height D:Depth



Universal Novel Tablet Kiosk



See movie at our website www.mtdisplays.com.tr



Smart Solutions for Technological Devices! Universal Novel Tablet Kiosk is suitable for iPad1, 2, 3, 4, Air, Samsung Galaxy and most 9.7"-10.1" tablets. The tablet holder can be rotated to display landscape portrait positions and tablet is secured with a lockable case to reduce the risk of theft. USB cable travels through the pole for cleaner view. The home button is covered to prevent interfering from the public. Universal Novel iPad Kiosk is suitable for retail purposes, trade shows and conventions as well as car galleries, furniture stores when the base is adjusted.

Packed unassembled with an easy to understand instruction for assembly.

USB cable is not included. Order separately. Fixing for floor mounting included.

Closed home button.

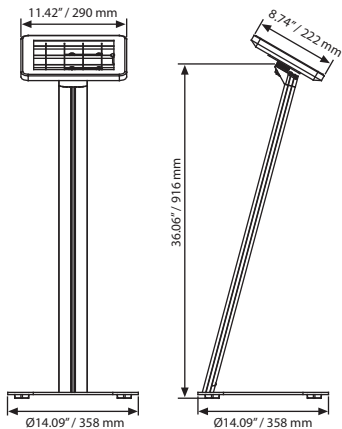

Don't forget to order USB cable.



TZZZ998701
Cable lock kit for iPad 82.68"



TSTDIC450B
Cable for all iPhones & iPads.



TSTDICP40B
Cable for iPhone 4S, iPad 3 and earlier.



TSTDICP50B
Cable for iPhone 5, iPad 4 and later.



TSTDICV80B
Cable V8, micro USB for Samsung, LG etc...



UYPPD0000
Lightning to 30-pin adapter. Packed by 10 pcs. You can use all type of Kiosk for iPad 4 too.

MATERIAL : Silver anodised aluminium		WEIGHT	PACKING SIZE
ARTICLE	DESCRIPTION	WITH PACKING	*W X H X D
UUTNON1B00	Silver	13.889 lbs	14.96" X 42.52" X 4.21"

* W:Width H: Height D: Depth





Universal Novel Tablet Kiosk for Wall & Freestanding



See movie at our website www.mtdisplays.com.tr



Smart Solutions for Technological Devices! Universal Novel Kiosk for wall or freestanding is suitable for iPad1, 2, 3, 4, Air, Samsung Galaxy and most 9.7"-10.1" tablets. The tablet holder can be rotated to display landscape portrait positions and tablet is secured with a lockable case to reduce the risk of theft. USB cable travels through the pole for cleaner view. The home button is covered to prevent interfering from the public. Universal Novel Kiosk is suitable for retail purposes, trade shows and conventions as well as car galleries, furniture stores. It is easily mounted on required height.

-  Packed unassembled with an easy to understand instruction for assembly.
-  USB cable is not included. Order separately. Fixing for floor mounting included.
-  Closed home button.

 Color options : Silver-anodized & black.

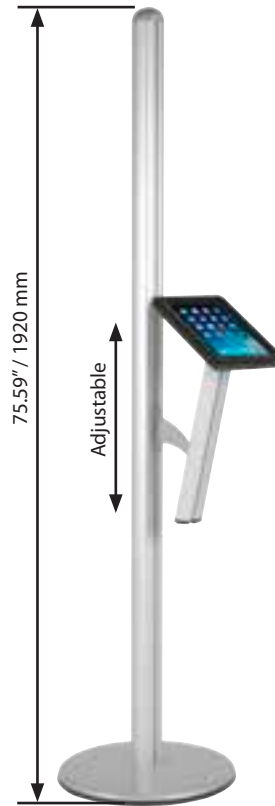

TZZZ998701
Cable lock kit for iPad 82.68".



UYPPD0000
Lightning to 30-pin adapter. Packed by 10 pcs. You can use all type of Kiosk for iPad 4 too.

For Wall

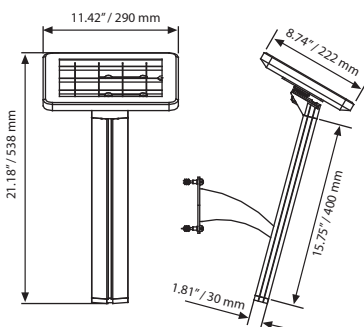

For Freestanding

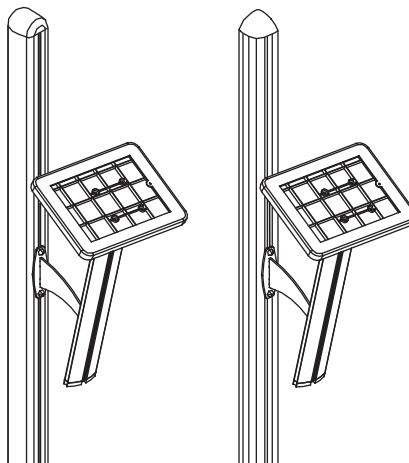

MATERIAL : Silver anodised aluminium		WEIGHT	PACKING SIZE
ARTICLE	DESCRIPTION	WITH PACKING	*W X H X D
UUTWON1B00	for Wall / White	4.960 lbs	12.20" X 18.90" X 8.27"
UUTWOB1B00	for Wall / Black	4.960 lbs	12.20" X 18.90" X 8.27"
UUTNFB1B00	for Freestanding / White	4.960 lbs	12.20" X 18.90" X 8.27"
UUTNFB1B00	for Freestanding / Black	4.960 lbs	12.20" X 18.90" X 8.27"



*W:Width H: Height D: Depth



Boomerang Floor Tablet Stand



With heavy wide feet, this Floor Standing stand suitable for iPad, iPad 2, iPad 3, Samsung 10.1" and any tablet from 9.7" to 10.1". Height adjustable from 4.53" to 5.28". It can be easily adjusted for comfortable view angle adjusting the angle 90 degrees.

-  Packed unassembled with an easy to understand instruction for assembly.
-  USB cable is not included. Order separately.
-  Suitable for both landscape and portrait use.

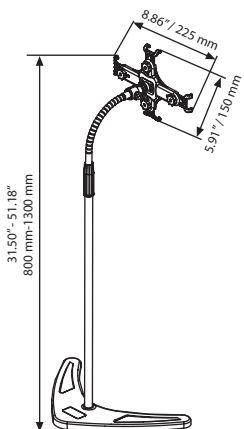

Don't forget to order USB cable.



TSTDCI450B
Cable for
iPhone 4&5.



TSTDCIP40B
Cable for
iPhone 4.



TSTDCIP50B
Cable for
iPhone 5.



TSTDCV80B
Cable V8 for
Samsung.



TZZZ998701
Cable lock kit for
iPad 82.68"

MATERIAL : ABS Plastic & Steel Stable Flat Base		WEIGHT	PACKING SIZE
ARTICLE	DESCRIPTION	WITH PACKING	*W X H X D
TGRIF40101	Black	10.288 lbs	11.42" X 30.71" X 3.66"



*W:Width H: Height D: Depth



Spider Floor Tablet Stand



This table stand is suitable for 9,5"-10,6" tablets. Height is adjustable so that convenient to use in sitting position. It is easy to adjust the angle of tablet holder for comfortable eye level. V shape base provides stability to the stand.

-  Packed unassembled with an easy to understand instruction for assembly.
-  USB cable is not included. Order separately.
-  Suitable for both landscape and portrait use.



One product, two positions (landscape & portrait)

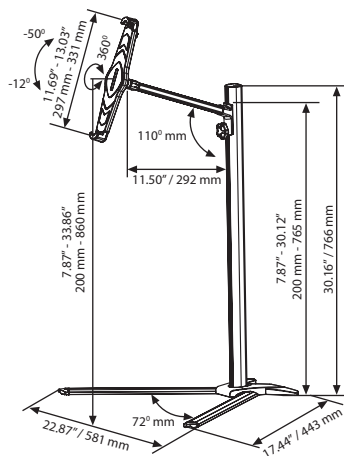
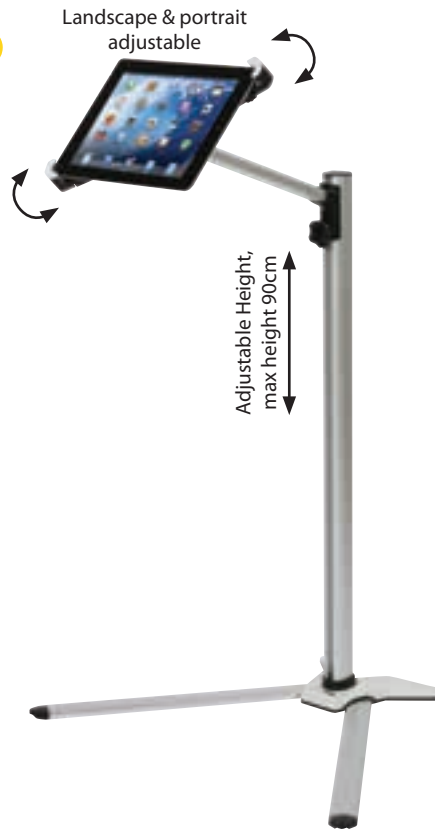

Don't forget to order USB cable.



TSTDCI450B
Cable for
iPhone 4&5.



TSTDCIP40B
Cable for
iPhone 4.



TSTDCIP50B
Cable for
iPhone 5.



TSTDCV80B
Cable V8 for
Samsung.



TZZZ998701
Cable lock kit for
iPad 82.68"

MATERIAL : ABS & Aluminium		WEIGHT	PACKING SIZE
ARTICLE	DESCRIPTION	WITH PACKING	*W X H X D
TLCP707009	Silver		12.20" X 32.28" X 3.66"



*W:Width H: Height D: Depth

TP 2 YEAR WARRANTY

Red Spider Floor Tablet Stand



360 degree rotatable tablet stand suitable for iPad 2, iPad 3 and iPad 4. It allows portrait and landscape viewing. Height is adjustable for comfortable eye view while sitting.

-  Packed unassembled with an easy to understand instruction for assembly.
-  USB cable is not included. Order separately.
-  Suitable for both landscape and portrait use.

 Color options : Silver-anodized & black.

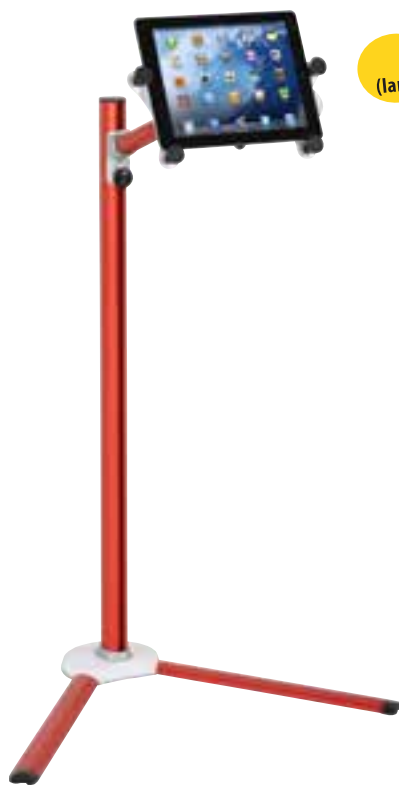

One product, two positions (landscape & portrait)

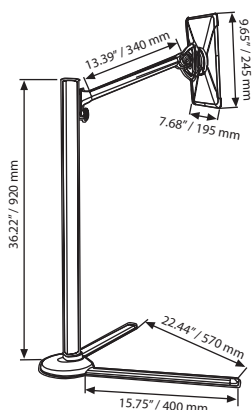

Don't forget to order USB cable.



TSTDIC450B
Cable for iPhone 4&5.



TSDCIP40B
Cable for iPhone 4.



TSDCIP50B
Cable for iPhone 5.



TSTDCV80B
Cable V8 for Samsung.



TZZZ998701
Cable lock kit for iPad 82.68\"/>

MATERIAL : ABS & Aluminium		WEIGHT	PACKING SIZE
ARTICLE	DESCRIPTION	WITH PACKING	*W X H X D
TGRIF80604	Red	6.393 lbs	9.84" X 37.01" X 3.15"

* W:Width H: Height D: Depth





Brochure Holders & Leaflet Displays



- Photo Frame
- Cross Frame
- Leaflet Dispensers
- Multiple Pocket Leaflet Dispensers
- Wall Mount Leaflet Dispensers
- Clear Brochure Holder T Type
- Clear Brochure Holder T Type
- L Type with front Pocket
- Swing Wing
- Pet Pocket
- Foldable Leaflet Holder
- Upright Leaflet Holder
- Oval Leaflet Holder
- Duo Desktop Menu Holder **NEW**
- Fort Desktop Menu Holder **NEW**
- Curved Desktop Menu Holder **NEW**
- Ticket Holder **NEW**
- Card Holder 2 Sided **NEW**
- Pyramid Card Holder **NEW**
- Arc Menu Holder **NEW**



Clear Frame



Clear window Frame is made of 0.12" acrylic and displays the poster as double sided. There are four strong suction cups to hold the sign for displaying the poster on glass doors or windows. The printed posters are easily inserted from top and sides, and remain mounted while changing them. These clear window frames are suitable to use at shop window, store entrances, restaurants etc.

-  Please clean the surface before applying the suction cup for better application. 4 suction cups included in the pack.
-  In large formats, 2 clear clips are included.
-  Please handle with care during transportation. Peel of the film over the product before use.

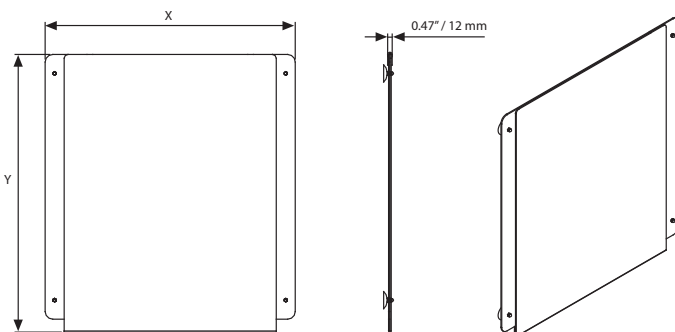

MATERIAL : Clear acrylic 0.12"				WEIGHT	PACKING SIZE
ARTICLE	EXTERNAL (x-y)	POSTER SIZE	DESCRIPTION	WITH PACKING	*W X H X D
UCF00Y0081	14.92" X 9.21"	8.5" X 11"	Landscape	1.477 lbs	9.06" X 16.54" X 1.22"
UCF00D0081	12.40" X 11.73"	8.5" X 11"	Portrait	1.543 lbs	11.42" X 13.78" X 1.22"
UCF00D0022	25.91" X 28.74"	22" X 28"	Portrait	7.738 lbs	27.56" X 28.74" X 1.22"
UCF00D0017	14.92" X 17.72"	11" X 17"	Portrait	2.854 lbs	16.14" X 17.72" X 1.22"
UCF00D0011	14.92" X 14.2"	11" X 14"	Portrait	2.314 lbs	14.57" X 16.14" X 1.22"



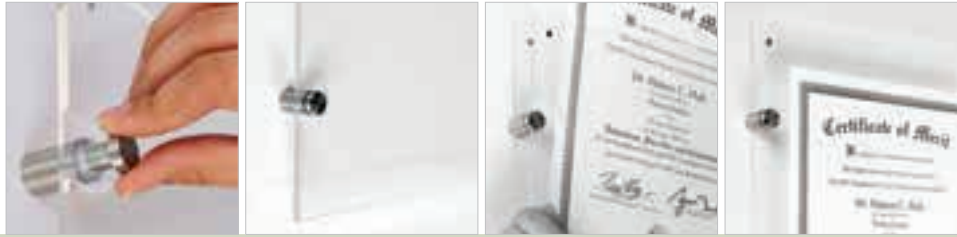

*W:Width H: Height D: Depth

Wall Mount Clear Acrylic Frame with Standoff Hardware and Magnets



Designed as frameless, Standoff Mount Acrylic Sign is a practical display system allowing to change poster when it is still on the wall by sliding. It is suitable for environments where the advertisement or promotions are changed very often such as offices, meeting rooms, travel agents, hotels, restaurants and many more. Standoff Mount Acrylic Sign is also suitable for branding.

 Peel off the film.

 Handle with care during transportation. Peel of the film over the product before use.

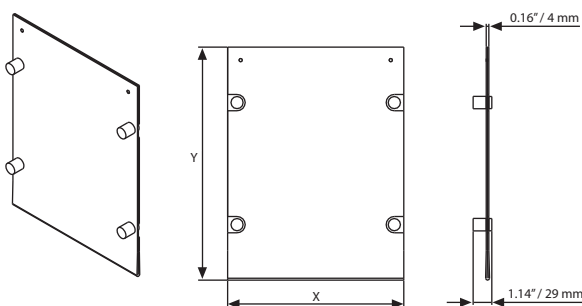

Fixing kit included.

MATERIAL : Clear acrylic 0.08"			WEIGHT	PACKING SIZE
ARTICLE	EXTERNAL (x-y)	POSTER SIZE	WITH PACKING	*W X H X D
USMSOD0081	10.87" X 13.37"	8.5" X 11"	1.234 lbs	11.81" X 18.11" X 1.77"
USMSOD0017	13.37" X 19.36"	11" X 17"	2.028 lbs	14.96" X 23.23" X 1.77"
USMSOD0018	20.36" X 26.36"	18" X 24"	4.409 lbs	21.26" X 27.56" X 1.57"
USMSOD0022	24.36" X 30.36"	22" X 28"	6.172 lbs	25.20" X 31.89" X 1.57"

*W:Width H: Height D: Depth



Table Top Clear Acrylic Frame



Contemporary poster or photo holder, Tabletop Clear Frame is suitable for both personal and commercial use. Transparent thick acrylic gets attention to the poster. Portrait or landscape adaptable decorative stands provide a smart finish for Tabletop L Frame.

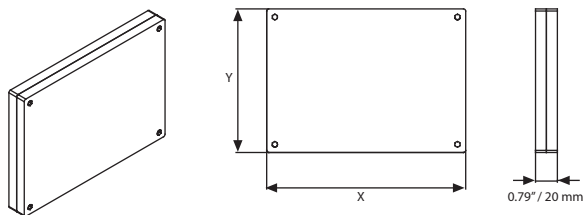
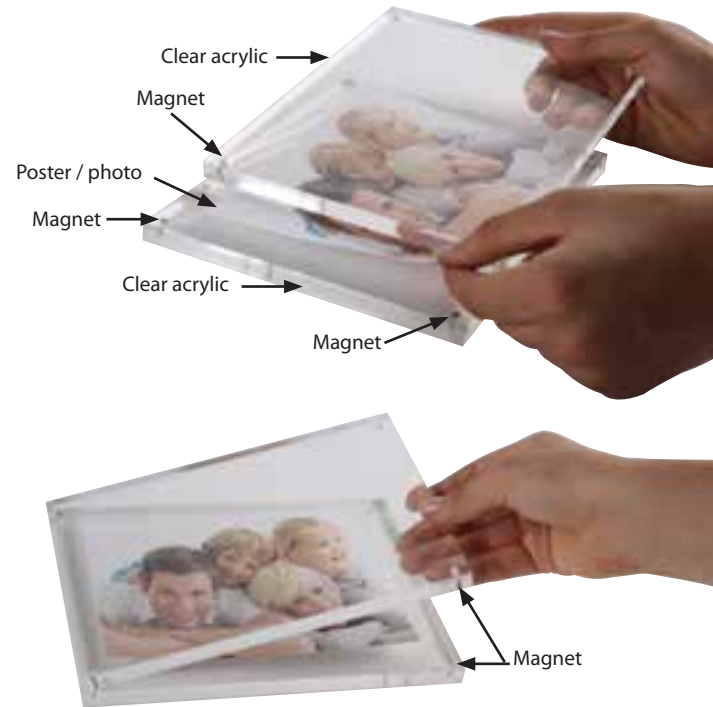

MATERIAL : Clear acrylic 0.39"			WEIGHT	PACKING SIZE
ARTICLE	EXTERNAL (x-y)	POSTER SIZE	WITH PACKING	*W X H X D
UMSTTCF046	7.18" X 5.18"	4" X 6"	1.366 lbs	6.30" X 8.66" X 4.92"
UMSTTCF057	8.18" X 6.18"	5" X 7"	1.851 lbs	7.09" X 9.45" X 4.92"

*W:Width H: Height D: Depth



Table Top Clear Acrylic L Frame with Standoff Hardware



Contemporary poster or photo holder, Tabletop L Frame is suitable for both personal and commercial use. Transparent thick acrylic gets the attention on the poster. Easily portrait or landscape adaptable decorative stands provide a smart finish for Tabletop L Frame. It holds the poster in place firm with magnets.



Chrome coated support allows for portrait or landscape format display on table tops.



Please handle with care during transportation. Please peel of the film over the product before use.

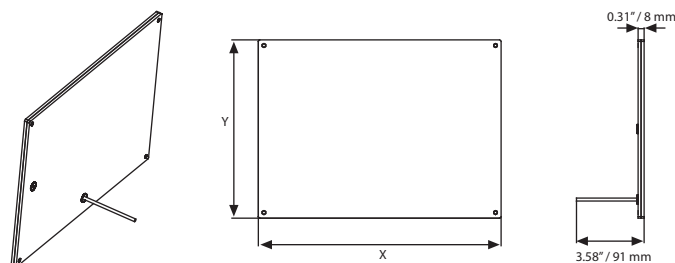
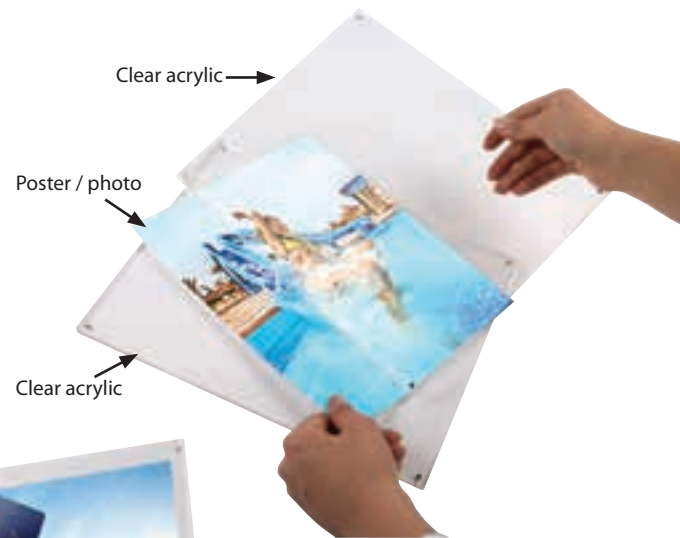

MATERIAL : Clear acrylic 0.16"			WEIGHT	PACKING SIZE
ARTICLE	EXTERNAL (x-y)	POSTER SIZE	WITH PACKING	*W X H X D
UMSTTLF046	7.18" X 5.18"	4" X 6"	0.793 lbs	0.63" X 0.87" X 0.26"
UMSTTLF057	8.18" X 6.20"	5" X 7"	1.014 lbs	0.71" X 0.94" X 0.26"
UMSTTLF081	12.19" X 9.69"	8.5" X 11"	2.204 lbs	1.06" X 1.42" X 0.26"

*W:Width H: Height D: Depth



Acrylic Photo Frame



Bended from 0.08" clear acrylic, Photo Frame serves various needs of both trade and even personal needs. Suitable to use for all kind of messages, menu lists as well as pictures. Pop-out feet is stable on the counter. Rounded corners provides elegant look to Photo Frame.

! Please handle with care during transportation. Please peel of the film over the product before use.



8.5" X 11" Size



5" X 7" Size

Slide-in photo →



Clear acrylic →

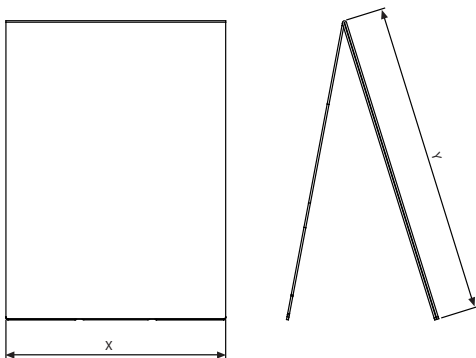
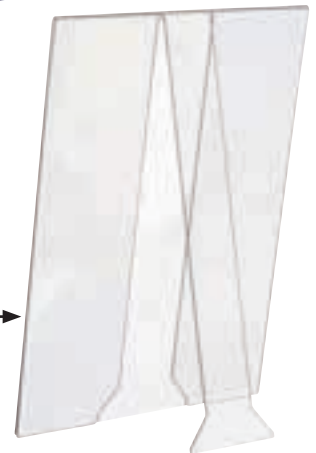

MATERIAL : Clear acrylic 0.08"			WEIGHT	PACKING SIZE
ARTICLE	EXTERNAL (x-y)	POSTER SIZE	WITH PACKING	*W X H X D
UMSPHT0046	4" X 6.12"	4" X 6"	0.242 lbs	7.87" X 15.75" X 5.51"
UMSPHT0058	5.5" X 8.62"	5.5" X 8.5"	0.418 lbs	11.02" X 15.75" X 7.48"
UMSPHT0057	5" X 7.12"	5" X 7"	0.330 lbs	9.06" X 15.75" X 6.69"
UMSPHT0081	8.5" X 11.12"	8.5" X 11"	0.837 lbs	15.75" X 14.17" X 9.84"
UMSPHT0010	8" X 10.12"	8" X 10"	0.771 lbs	12.20" X 15.75" X 9.45"

*W:Width H: Height D: Depth



Cross Frame



Clear sing holder, Cross Frame allows advertising many messages accepting 8 posters a time. Flat packed Cross Frame saves from space. Rounded corners provides elegant look to Cross Frame. Made of 0.08" clear acrylic.

! Please handle with care during transportation. Please peel of the film over the product before use.



4 X (5.5" X 8.5") Size



4 X (4" X 6") Size



Bottom part



Top part

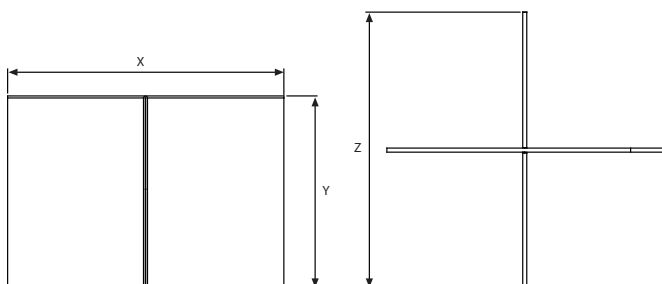

MATERIAL : Clear acrylic 0.08"						WEIGHT	PACKING SIZE
ARTICLE	POSTER SIZE	CAPACITY	X	Y	Z	WITH PACKING	*W X H X D
UMSCR00446	4"X6"	4 X (4"X6")	8.23"	6.10"	8.23"	0.771 lbs	10.24" X 11.42" X 7.09"
UMSCR00458	5.5"X8.5"	4 X (5.5"X8.5")	11.22"	8.58"	11.22"	1.477 lbs	5.91" X 13.39" X 9.84"
UMSCR00457	5"X7"	4 X (5"X7")	10.20"	7.09"	10.20"	0.992 lbs	11.42" X 12.20" X 8.27"

*W:Width H: Height D: Depth



Counter Top Brochure Holders



Highly resistant transparent document holders. Format 8.5"x11" is suitable for the display of all types of documents such as catalogues, brochures, cards for every need, etc... These high quality injection molded leaflet dispensers can be screen printed with logo on your request. Now it is ready with a unit divider for 8.5"x11" portrait into 4"x6" size.

Silk Screen Printing on Leaflet Dispensers

Minimum Pad Printing quantity is 200 pcs. Please note the printing operations may extend the lead times. During each printing operation, a visual image of logo is requested as a Illustrator file. The maximum printing area on the dispenser is as follows.

! Please handle with care during transportation.



"Colour options RED GREEN YELLOW BLUE. Available with MOQ"

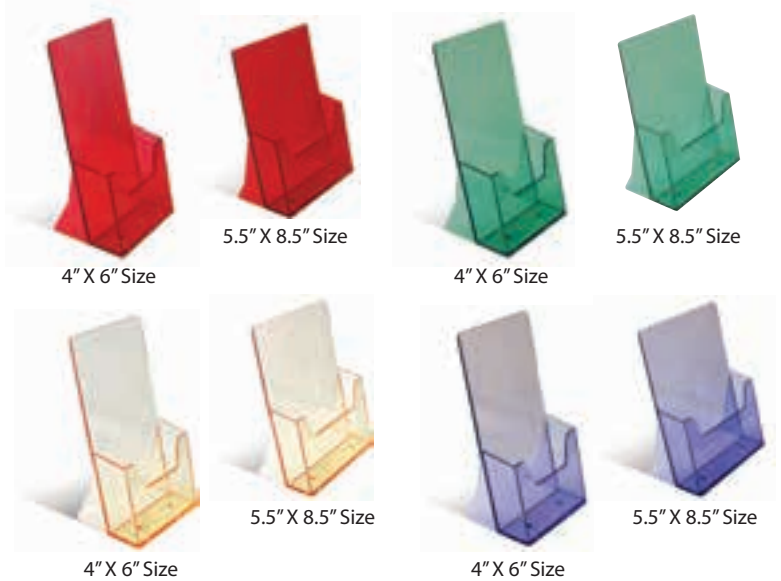

4" X 6" Size

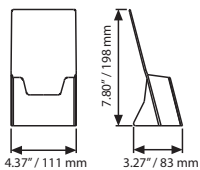

5.5" X 8.5" Size

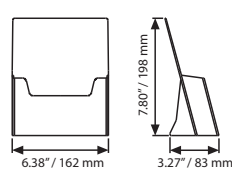

MATERIAL : Clear		
SIZE	PRINTING SIZE	DESCRIPTION
4" X 6"	1.57" X 3.54"	Portrait
5.5" X 8.5"	2.17" X 5.51"	Portrait

MATERIAL : Clear			WEIGHT	PACKING SIZE
ARTICLE	POSTER	DESCRIPTION	WITH PACKING	*W X H X D
UMSD001004	5.83" X 8.27"	5.5" X 8.5" Portrait	19.488 lbs	20.47" X 24.80" X 9.84" (40 pcs)
UMSD001003	3.94" X 8.27"	4" X 6" Portrait	16.093 lbs	18.90" X 25.20" X 8.27" (50 Pcs)

* W:Width H: Height D: Depth



Multiple Pocket Brochure Holders

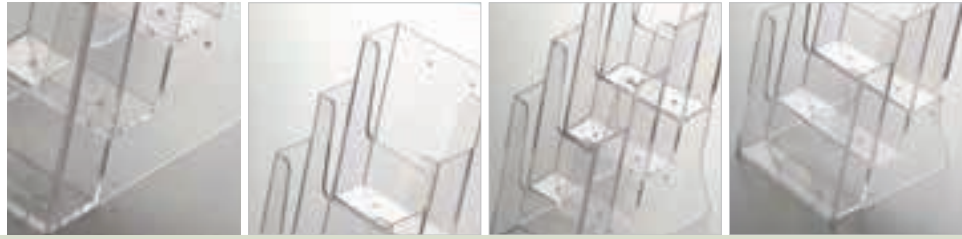

Highly resistant transparent document holders. Dispensers can be screen printed with corporate logo. Our products are made of the finest materials while providing the highest level of quality and clarity.

! Please handle with care during transportation.



3 X (5.5" X 8.5") Portrait



3 X (4" X 6") Portrait



4 X (4" X 6") Portrait

3 X (4" X 6") Portrait

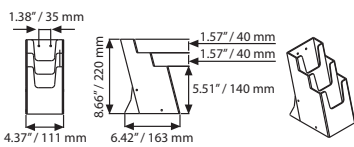

3 X (5.5" X 8.5) Portrait

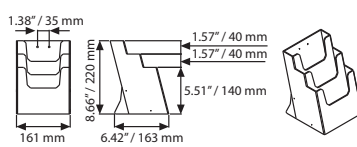

4 X (4" X 6") Portrait

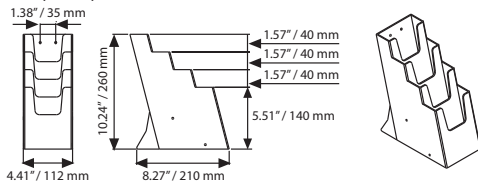

MATERIAL : Clear		WEIGHT	PACKING SIZE
ARTICLE	POSTER	DESCRIPTION	*W X H X D
UMSD003050	3.94" X 8.27"	4 X (4" X 6") Portrait	17.085 lbs 14.96" X 27.56" X 14.17" (18 pcs)
UMSD004000	5.83" X 8.27"	3 X (5.5" X 8.5") Portrait	13.845 lbs 14.96" X 22.05" X 13.78" (12 pcs)
UMSD005000	3.94" X 8.27"	3 X (4" X 6") Portrait	18.959 lbs 14.96" X 32.68" X 9.84" (20 pcs)

* W:Width H: Height D: Depth



Wall Mount Brochure Holders



Highly resistant transparent document holders. They can be mounted in any convenient location. They come in 4 sizes and the clear pocket is ideal for the display of menus, price lists, etc.. These high quality brochure holders can be screen printed. All models are in stock and ready for immediate shipment.

Silk Screen Printing on Wall Mount Leaflet Dispensers

The minimum pad printing quantity is 200 pcs. Please note the printing operations may extend the lead time. In each printing operation, a visual image of the logo is requested as a Illustrator file. The maximum printing area on the wall mount dispensers is as follows.

! Please handle with care during transportation.



8.5" X 11" Size



5.5" X 8.5" Size



4" X 6" Size

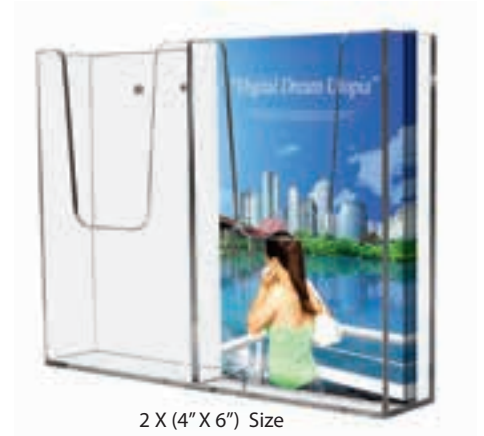

2 X (4" X 6") Size

4" X 6" Size

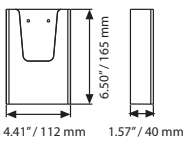

4.41" / 112 mm 1.57" / 40 mm

2 X (4" X 6") Size

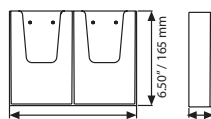

8.74" / 222 mm 1.57" / 40 mm

8.5" X 11" Size

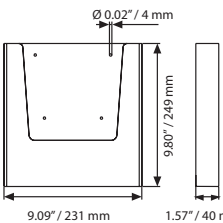

9.09" / 231 mm 1.57" / 40 mm

5.5" X 8.5" Size

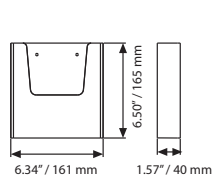

6.34" / 161 mm 1.57" / 40 mm

MATERIAL : Clear

SIZE	PRINTING SIZE	DESCRIPTION
4" X 6"	2.36" X 3.54"	Portrait
5.5" X 8.5"	2.36" X 5.51"	Portrait
8.5" X 11"	2.36" X 7.87"	Portrait

MATERIAL : Clear

ARTICLE	POSTER	DESCRIPTION	WEIGHT	PACKING SIZE
			WITH PACKING	*W X H X D
UMSD008100	8.5" X 11"	8.5" X 11" Portrait	28.439 lbs	20.47" X 24.80" X 9.84" (30 Pcs)
UMSD007000	5.5" X 8.5"	5.5" X 8.5" Portrait	20.502 lbs	21.26" X 25.20" X 7.48" (45 pcs)
UMSD006000	4" X 6"	4" X 6" Portrait	20.392 lbs	18.90" X 25.20" X 8.27" (60 Pcs)
UMSD006010	2 X (4" X 6")	2 X (4" X 6") Portrait	22.046 lbs	18.90" X 25.20" X 8.27" (30 Pcs)

* W:Width H: Height D: Depth



Clear Brochure Holder T Type



Highly resistant transparent document holders. Ideal for the display of menus at restaurants, price lists, etc... These high quality clear brochure holders can be screen printed with corporate logo. Non-standard sizes can be produced according to customer specification & needs; for printing and quantities, please contact our sales department.

! Please handle with care during transportation. Please peel of the film over the product before use.



8.5" X 11" Portrait



4" X 6" Portrait



5" X 7" Portrait



5" X 7" Landscape

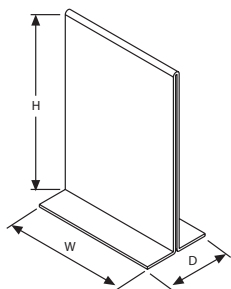

MATERIAL : Clear						WEIGHT	PACKING SIZE
ARTICLE	POSTER	DESCRIPTION	W	H	D	WITH PACKING	*W X H X D
UMSTD05000	8.5" X 11"	8.5" X 11" Portrait	8.5"	11.22"	4.13"	32.848 lbs	18.50" X 26.38" X 9.65" (40 pcs)
UMSTY05000	8.5" X 11"	8.5" X 11" Landscape	11"	8.70"	4.13"	24.250 lbs	26.77" X 18.11" X 9.65" (30 pcs)
UMSTD09000	5" X 7"	5" X 7" Portrait	5"	7.20"	2.95"	12.698 lbs	13.78" X 17.72" X 7.09" (30 pcs)
UMSTY09000	5" X 7"	5" X 7" Landscape	7"	5.20"	2.95"	12.698 lbs	12.99" X 13.78" X 9.65" (30 pcs)
UMSTD08000	4" X 6"	4" X 6" Portrait	4"	6.21"	4.13"	10.802 lbs	16.93" X 20.08" X 5.51" (40 pcs)
UMSTY08000	4" X 6"	4" X 6" Landscape	6"	4.21"	4.13"	15.432 lbs	13.78" X 16.14" X 9.25" (30 pcs)

* W:Width H: Height D: Depth



Clear Brochure Holder L Type & with Front Pocket



The highly resistant transparent document holders are ideal for the display of menus at restaurants, price lists, etc... These high quality clear brochure holders can be screen printed with a corporate logo. Non-standard sizes can be produced according to customer specification & needs; for printing and quantities, please contact our sales department.

advantage of the product is the pocket in front of the brochure holder, so that any poster, menu, advertising info can be put in. The advantageous pocket enables you to place your business card on the poster. This product can be produced in different sizes on request. Highly resistant transparent document holders. These high quality clear brochure holders can be screen printed with a corporate logo.

! Please handle with care during transportation. Please peel of the film over the product before use.

Our new range of sign holders offers competitive solutions to effect a maximum outcome for your sales and marketing activities. The main



8.5" X 11" Portrait



4" X 6" Portrait



5" X 7" Portrait



8.5" X 11" with Front Pocket Portrait



5" X 7" Landscape

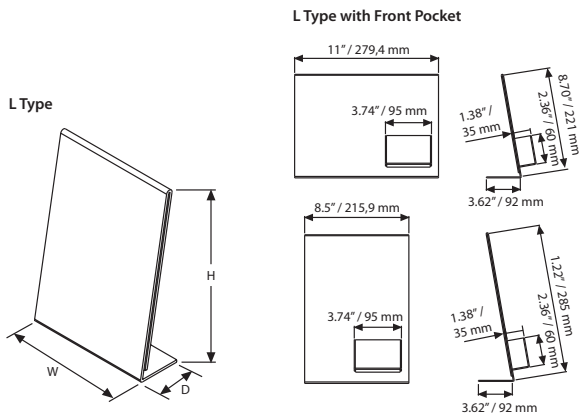

L TYPE WITH FRONT POCKET: Clear			WEIGHT	PACKING SIZE
ARTICLE	POSTER	DESCRIPTION	WITH PACKING	*W X H X D
UMSLDC1000	8.5" X 11"	8.5"X11" Portrait	9.369 lbs	9.45" X 13.78" X 1.34" (10 pcs)
UMSLYC1000	11" X 8.5"	8.5"X11" Landscape	9.810 lbs	9.45" X 13.78" X 1.34" (10 pcs)

MATERIAL : Clear						WEIGHT	PACKING SIZE
ARTICLE	POSTER	DESCRIPTION	W	H	D	WITH PACKING	*W X H X D
UMSLD06000	8.5" X 11"	8.5" X 11" Portrait	8.5"	11.22"	3.62"	25,353 lbs	13.39" X 14.57" X 9.45" (40 pcs)
UMSLY06000	8.5" X 11"	8.5" X 11" Landscape	11"	8.70"	3.62"	22,046 lbs	13.39" X 14.57" X 9.45" (30 pcs)
UMSLD01057	5" X 7"	5" X 7" Portrait	5"	7.20"	2.83"	12,698 lbs	12.60" X 13.78" X 9.45" (30 pcs)
UMSLY01057	5" X 7"	5" X 7" Landscape	7"	5.20"	2.83"	12,698 lbs	12.60" X 13.78" X 9.45" (30 pcs)
UMSLD09000	4" X 6"	4" X 6" Portrait	4"	6.21"	2.83"	9,259 lbs	13.39" X 15.35" X 9.45" (40 pcs)
UMSLY09000	4" X 6"	4" X 6" Landscape	6"	4.21"	2.83"	15,432 lbs	13.39" X 15.35" X 9.45" (50 pcs)

*W:Width H: Height D: Depth



Swing Wing

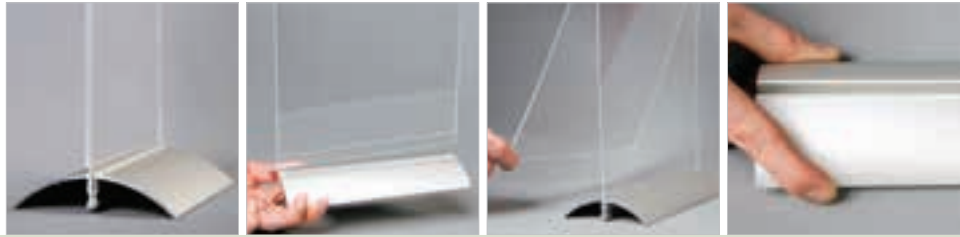

Classy menu holder with a clear acrylic pocket and stylish silver-anodized aluminum base. Acrylic pockets fits securely into aluminium base. Ideal for the display of menus. Non-standard sizes can be produced according to customer needs. The aluminum base is suitable for logo printing. Max letter height in printing is 1.57". Several poster materials can be used with this base; PVC Foam, PS, PET. The thickness varies between 0.04" - 0.16".

! Please handle with care during transportation. Please peel of the film over the product before use.



8.5" X 11" Portrait

← Catch thickness
min. 0.04"
max. 0.16"



4" X 6" Portrait



5" X 7" Portrait



5" X 7" Landscape

MATERIAL : Silver anodised aluminium			WEIGHT	PACKING SIZE
ARTICLE	POSTER	DESCRIPTION	WITH PACKING	*W X H X D
USWMDNP004	4"	Aluminium base	1.058 lbs	5.12" X 7.87" X 4.33" (12 pcs)
USWMDNP005	5"	Aluminium base	1.984 lbs	5.91" X 7.09" X 4.72" (12 pcs)
USWMDNP006	6"	Aluminium base	2.513 lbs	6.69" X 7.09" X 4.72" (12 pcs)
USWMDNP007	7"	Aluminium base	2.645 lbs	6.69" X 7.09" X 4.72" (12 pcs)
USWMDNP085	8.5"	Aluminium base	3.306 lbs	7.09" X 9.06" X 4.72" (12 pcs)
USWMDNP011	11"	Aluminium base	4.100 lbs	7.09" X 11.81" X 4.72" (12 pcs)

MATERIAL : Silver anodised aluminium & clear acrylic			WEIGHT	PACKING SIZE
ARTICLE	POSTER	DESCRIPTION	WITH PACKING	*W X H X D
USWMDNP046	4" X 6"	Aluminium base & Acrylic - Portrait	8.686 lbs	9.65" X 13.78" X 3.39" (30 pcs)
USWMDNP057	5" X 7"	Aluminium base & Acrylic - Portrait	4.894 lbs	9.84" X 13.78" X 3.54" (10 pcs)
USWMDNP058	5.5" X 8.5"	Aluminium base & Acrylic - Portrait	13.227 lbs	9.65" X 13.78" X 3.39" (25 pcs)
USWMDNP081	8.5" X 11"	Aluminium base & Acrylic - Portrait	13.933 lbs	9.65" X 13.78" X 3.39" (15 pcs)

ARTICLE	POSTER	DESCRIPTION	WITH PACKING	*W X H X D
USWMDNP046	4" X 6"	Aluminium base & Acrylic - Landscape	8.961 lbs	9.65" X 13.78" X 3.39" (25 pcs)
USWMDNP057	5" X 7"	Aluminium base & Acrylic - Landscape	0.485 lbs	7.09" X 7.87" X 4.72" (10 pcs)
USWMDNP058	5.5" X 8.5"	Aluminium base & Acrylic - Landscape	8.785 lbs	9.65" X 13.78" X 3.39" (15 pcs)
USWMDNP081	8.5" X 11"	Aluminium base & Acrylic - Landscape	10.604 lbs	9.65" X 13.78" X 3.39" (10 pcs)

*W:Width H: Height D: Depth

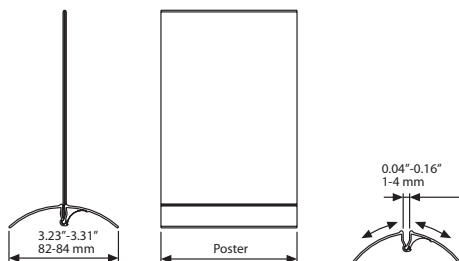

Pet Pocket U+C+D Type

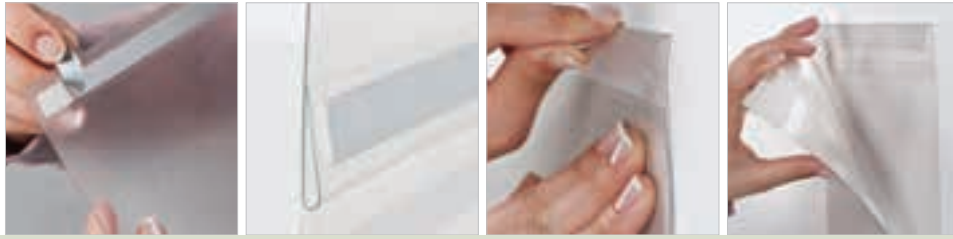

Anti-clear high resistant PET transparent clear document holders. Ideal for the display of menus at the restaurants, price lists, etc... They are suitable for screen printing. Non standard sizes can be produced to customer specification & needs; for printing and quantities please contact our sales executives.

! Please handle with care during transportation.

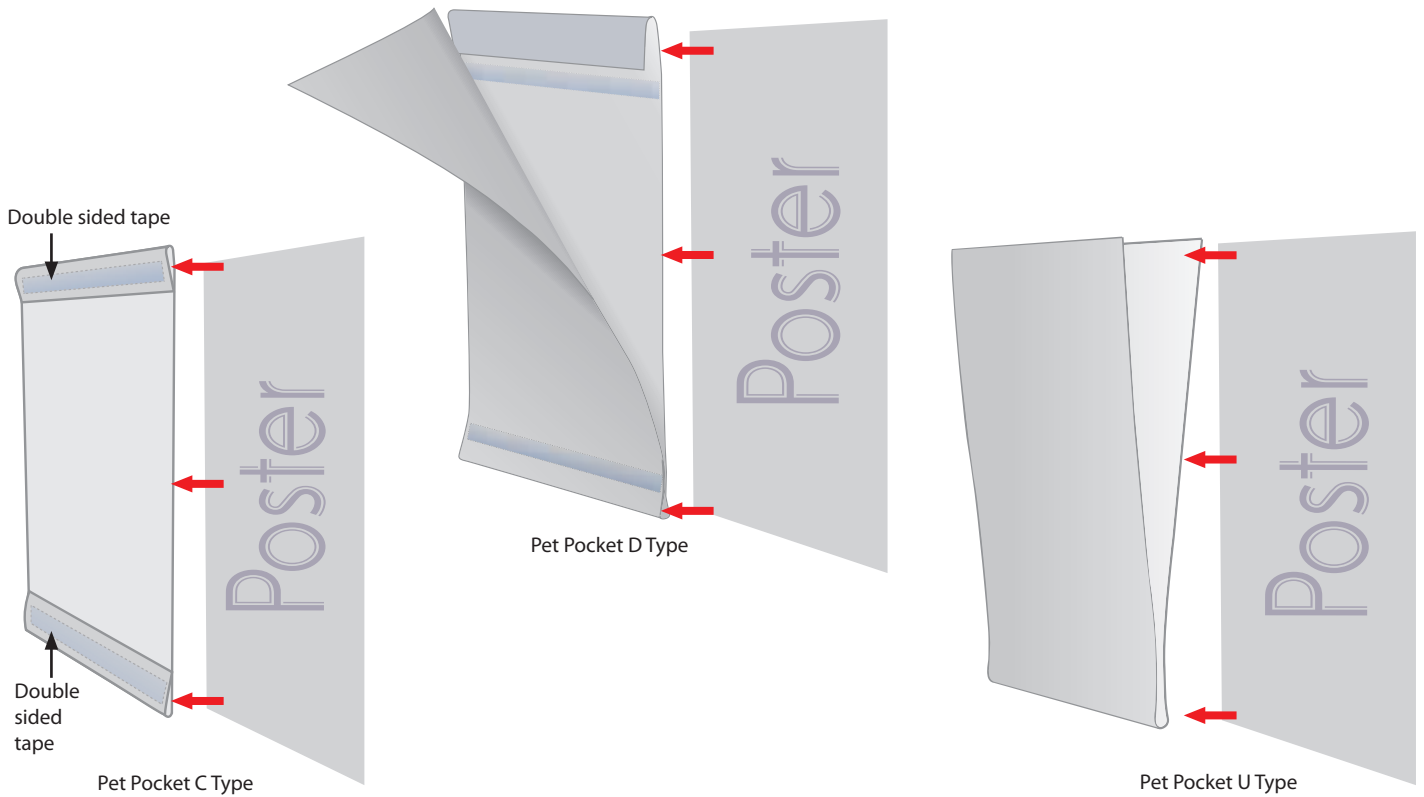

Pet Pocket D Type

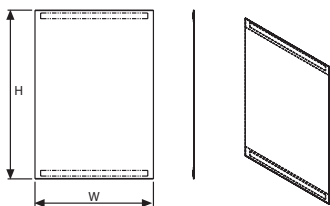

Pet Pocket C Type

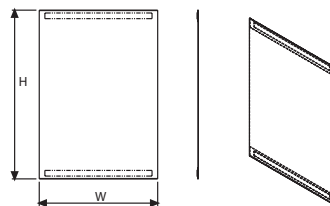

Pet Pocket U Type

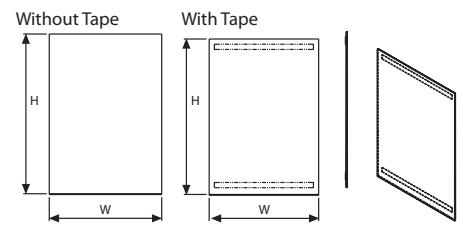



Pet Pocket , no tools required, mount it in less than a minute!

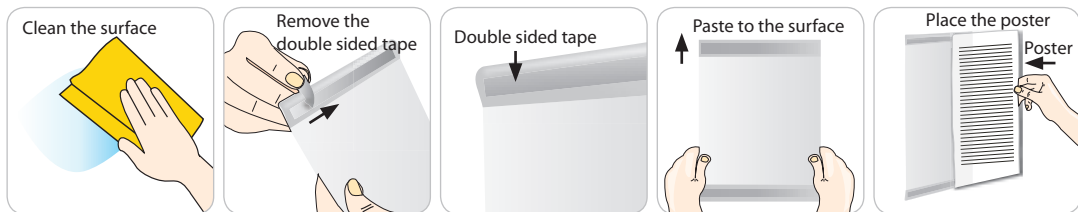

PET POCKET C TYPE : Clear					WEIGHT	PACKING SIZE
ARTICLE	POSTER	DESCRIPTION	W	H	WITH PACKING	*W X H X D
UPCC1D0081	8.5" X 11"	8.5" X 11" Portrait	8.5"	11.14"	2.425 lbs	10.04" X 12.99" X 3.35" (25 pcs)
UPCC1Y0081	8.5" X 11"	8.5" X 11" Landscape	11"	8.62"	2.425 lbs	10.04" X 12.99" X 3.35" (25 pcs)
UPCC1D0057	5" X 7"	5" X 7" Portrait	5"	7.13"	1.984 lbs	6.50" X 9.06" X 3.35" (50 pcs)
UPCC1Y0057	5" X 7"	5" X 7" Landscape	7"	5.12"	1.984 lbs	6.50" X 9.06" X 3.35" (50 pcs)

PET POCKET D TYPE : Clear					WEIGHT	PACKING SIZE
ARTICLE	POSTER	DESCRIPTION	W	H	WITH PACKING	*W X H X D
UPCD1D0081	8.5" X 11"	8.5" X 11" Portrait	8.5"	11.14"	4.629 lbs	10.04" X 12.99" X 3.35" (25 pcs)
UPCD1Y0081	8.5" X 11"	8.5" X 11" Landscape	11"	8.62"	4.629 lbs	10.04" X 12.99" X 3.35" (25 pcs)
UPCD1D0057	5" X 7"	5" X 7" Portrait	5"	7.13"	3.747 lbs	6.50" X 9.06" X 3.35" (50 pcs)
UPCD1Y0057	5" X 7"	5" X 7" Landscape	7"	5.12"	3.747 lbs	6.50" X 9.06" X 3.35" (50 pcs)

PET POCKET U TYPE : Clear						WEIGHT	PACKING SIZE
WITHOUT TAPE	WITH TAPE	POSTER	DESCRIPTION	W	H	WITH PACKING	*W X H X D
UPCU0D0081	UPCU1D0081	8.5" X 11"	8.5" X 11" Portrait	8.5"	11.06"	9.920 lbs	10.04" X 12.99" X 3.35" (25 pcs)
UPCU0Y0081	UPCU1Y0081	8.5" X 11"	8.5" X 11" Landscape	11"	8.54"	9.920 lbs	10.04" X 12.99" X 3.35" (25 pcs)
UPCU0D0057	UPCU1D0057	5" X 7"	5" X 7" Portrait	5"	7.05"	4.629 lbs	6.50" X 9.06" X 3.35" (50 pcs)
UPCU0Y0057	UPCU1Y0057	5" X 7"	5" X 7" Landscape	7"	5.04"	4.629 lbs	6.50" X 9.06" X 3.35" (50 pcs)

* W:Width H: Height D: Depth



Foldable Leaflet Holder

Upright Leaflet Holder



It's a foldable, light weight injected unit. Affordable way to present advertisements, price on product information, warnings on menus at various commercial environments.

Upright leaflet holder is an ideal plastic frame for prints. It serves as a menu holder or frame for advertisements. It's a light weight and double sided unit. Prints are easy to change from top & sides.

! Please handle with care during transportation.

Foldable Leaflet Holder



5" X 7" portrait



4" X 6" portrait

Upright Leaflet Holder



8.5" X 11" portrait



5" X 7" portrait



4" X 6" portrait

Foldable Leaflet Holder

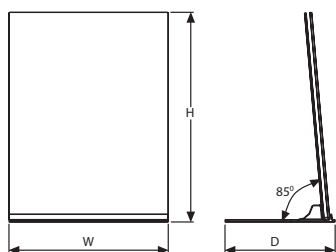

Upright Leaflet Holder

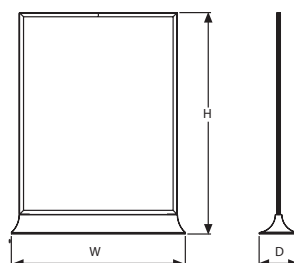

UPRIGHT LEAFLET HOLDER: Clear					WEIGHT	PACKING SIZE (25 Pcs)
ARTICLE	POSTER	W	H	D	WITH PACKING	*W X H X D
UMSDTLDN46	4" X 6"	5.12"	7.17"	1.57"	5.621 lbs	8.27" X 12.60" X 11.42"
UMSDTLDN57	5" X 7"	6.30"	8.35"	1.81"	9.369 lbs	9.45" X 14.57" X 14.17"
UMSDTLDN81	8.5" X 11"	9.84"	12.52"	2.20"	19.621 lbs	16.93" X 27.56" X 10.24"

FOLDABLE LEAFLET HOLDER: Clear					WEIGHT	PACKING SIZE (25 Pcs)
ARTICLE	POSTER	W	H	D	WITH PACKING	*W X H X D
UMSDFLDN46	4" X 6"	4.06"	6.26"	3.94"	5.511 lbs	8.66" X 11.02" X 10.24"
UMSDFLDN57	5" X 7"	5.04"	7.28"	4.33"	8.487 lbs	9.84" X 11.02" X 12.20"

* W:Width H: Height D: Depth



Oval Leaflet Holder



Modern style leaflet holder is light and affordable. Unit is injection molded, clear and double sided. Suitable for use as menu cards in restaurants as leaflet holder in shops and any commercial environment.

! Please handle with care during transportation.



8.5" X 11" portrait



5" X 7" portrait



4" X 6" portrait

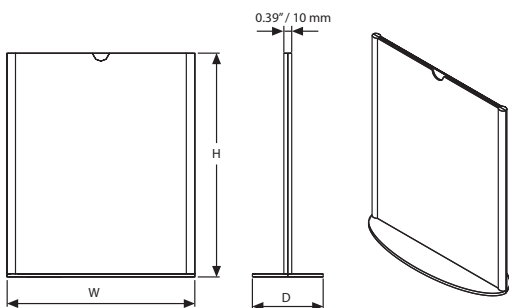

MATERIAL : Clear					WEIGHT	PACKING SIZE (25 Pcs)
ARTICLE	POSTER	W	H	D	WITH PACKING	*W X H X D
UMSDOLDN46	4" X 6"	4.88"	6.18"	2.56"	6.338 lbs	11.42" X 12.99" X 7.87"
UMSDOLDN57	5" X 7"	5.91"	7.20"	2.76"	9.259 lbs	13.39" X 14.17" X 9.06"
UMSDOLDN81	8.5" X 11"	9.45"	11.20"	3.54"	22.156 lbs	16.93" X 21.26" X 12.99"

*W:Width H: Height D: Depth





Duo Desktop Menu Holder, Straight Cut & Vintage Cut

new



Modern style beech wood menu holder is light and affordable. Suitable for use in restaurants, retail stores and any commercial environment. Simply slide the leaflet into grooves of the wooden columns and place the menu between wooden columns and back support. Prints are easy to change from top. Duo Desktop Menu Holder are made of the finest materials while providing the highest level of quality. Basic and vintage styles offers options to users. To ensure sustainability of the quality in use, wood menu holders are lacquered finished which is resistant to spill of food and fizzy drinks.

-  Acrylic or PET poster pockets and chalkboards are optional.
-  Grooves of wooden columns is 0.18" which accepts acrylic or PET pockets and chalk board.
-  Packed in multiples.

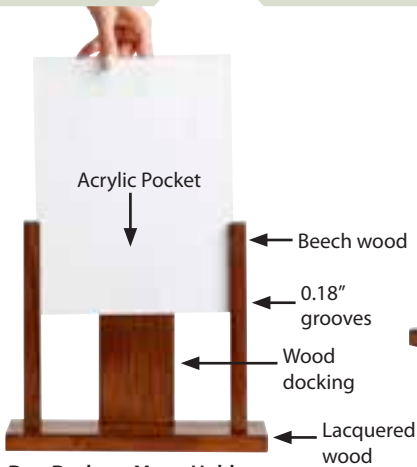

Duo Desktop Menu Holder, Straight Cut, Dark Wood



Dark Wood - 8.5"x11"
PET optional



Dark Wood - 5x5"x8.5"
Acrylic optional



Dark Wood - 5x5"x8.5"
Chalkboard optional



Duo Desktop Menu Holder, Vintage Cut, Natural Wood



Natural Wood - 8.5"x11"
Acrylic optional



Natural Wood - 5x5"x8.5"
PET optional



Natural Wood - 5.5"x8.5"
Chalkboard optional

Do not forget to order PET, or Acrylic pockets or Chalkboard

Duo Desktop Menu Holder, Straight Cut

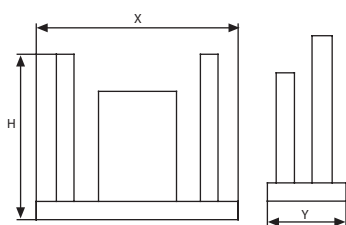

Duo Desktop Menu Holder, Vintage Cut

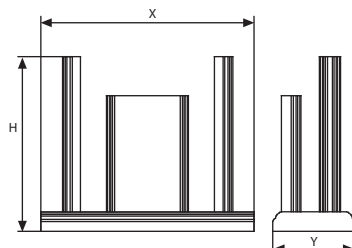

DUO DESKTOP MENU HOLDER, STRAIGHT CUT: Beech wood						WEIGHT	PACKING SIZE (2 Pcs)
ARTICLE	SIZE	DESCRIPTION	X	Y	H	WITH PACKING	*W X H X D
UWDMODNOA4	8.5"x11"	Natural Wood	11.30"	3.35"	9.84"	1.212 lbs	11.42" X 12.20" X 3.94"
UWDMODNOA5	5.5"x8.5"	Natural Wood	8.66"	3.35"	7.09"		8.66" X 9.45" X 3.94"
UWDMODDOA4	8.5"x11"	Dark Wood	11.30"	3.35"	9.84"	1.212 lbs	11.42" X 12.20" X 3.94"
UWDMODDOA5	5.5"x8.5"	Dark Wood	8.66"	3.35"	7.09"		8.66" X 9.45" X 3.94"

DUO DESKTOP MENU HOLDER, VINTAGE CUT: Beech wood						WEIGHT	PACKING SIZE (2 Pcs)
ARTICLE	SIZE	DESCRIPTION	X	Y	H	WITH PACKING	*W X H X D
UWDMVDNOA4	8.5"x11"	Natural Wood	11.30"	3.35"	9.84"		11.42" X 12.20" X 3.94"
UWDMVDNOA5	5.5"x8.5"	Natural Wood	8.66"	3.35"	7.09"		8.66" X 9.45" X 3.94"
UWDMVDDOA4	8.5"x11"	Dark Wood	11.30"	3.35"	9.84"		11.42" X 12.20" X 3.94"
UWDMVDDOA5	5.5"x8.5"	Dark Wood	8.66"	3.35"	7.09"		8.66" X 9.45" X 3.94"



* W:Width H: Height D: Depth

Fort Desktop Menu Holder, Straight Cut & Vintage Cut

new



Modern style, made of beech wood, Fort Desktop Menu Holder is light and affordable solution for restaurants, retail stores and any commercial environment. Simply slide the leaflet into grooves of the wooden columns. Prints are easy to change from top. Fort Desktop Menu Holder is made of the finest materials while providing the highest level of quality. Basic and vintage styles offers options to users. To ensure sustainability of the quality, wood menu holders are lacquered finished which is resistant to spill of food and fizzy drinks.



Acrylic or PET poster pockets and chalkboards are optional.



Frooves of wooden columns is 0.18" which accepts acrylic or PET pockets and chalk board.



Packed in multiples.

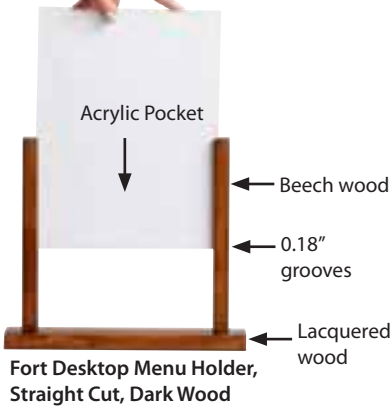

Fort Desktop Menu Holder, Straight Cut, Dark Wood



Dark Wood - 8.5"x11" PET optional



Dark Wood - 5x5"x8.5" Acrylic optional



Dark Wood - 5x5"x8.5" Chalkboard optional



Fort Desktop Menu Holder, Vintage Cut, Natural Wood



Natural Wood - 8.5"x11" PET optional



Natural Wood - 5x5"x8.5" Acrylic optional



Natural Wood - 8.5"x11" Chalkboard optional

Do not forget to order PET, or Acrylic pockets or Chalkboard

Fort Desktop Menu Holder, Straight Cut

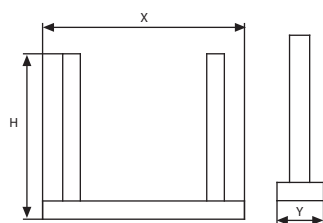

Fort Desktop Menu Holder, Vintage Cut

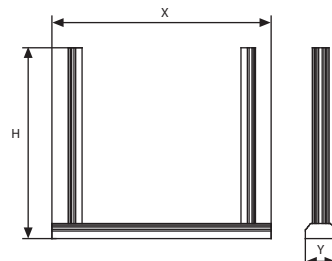

FORT DESKTOP MENU HOLDER, STRAIGHT CUT : Beech wood						WEIGHT	PACKING SIZE (2 Pcs)
ARTICLE	SIZE	DESCRIPTION	X	Y	H	WITH PACKING	*W X H X D
UWDMOFNOA4	8.5"x11"	Natural Wood	11.30"	1.57"	9.84"	1.212 lbs	11.42" X 12.20" X 3.94"
UWDMOFNOA5	5.5"x8.5"	Natural Wood	8.66"	1.57"	7.09"		8.66" X 9.45" X 3.94"
UWDMOFDOA4	8.5"x11"	Dark Wood	11.30"	1.57"	9.84"	1.212 lbs	11.42" X 12.20" X 3.94"
UWDMOFDOA5	5.5"x8.5"	Dark Wood	8.66"	1.57"	7.09"		8.66" X 9.45" X 3.94"

FORT DESKTOP MENU HOLDER, VINTAGE CUT : Beech wood						WEIGHT	PACKING SIZE (2 Pcs)
ARTICLE	SIZE	DESCRIPTION	X	Y	H	WITH PACKING	*W X H X D
UWDMVFNOA4	8.5"x11"	Natural Wood	11.30"	1.57"	9.84"		11.42" X 12.20" X 3.94"
UWDMVFNOA5	5.5"x8.5"	Natural Wood	8.66"	1.57"	7.09"		8.66" X 9.45" X 3.94"
UWDMVFDOA4	8.5"x11"	Dark Wood	11.30"	1.57"	9.84"		11.42" X 12.20" X 3.94"
UWDMVFDOA5	5.5"x8.5"	Dark Wood	8.66"	1.57"	7.09"		8.66" X 9.45" X 3.94"

* W:Width H: Height D: Depth



Curved Desktop Menu Holder

new



Modern style beech plywood menu holder is light and affordable. Suitable for use in restaurants, retail stores and any commercial environment. Simply slide the leaflets in to PET pocket and then slide the PET pocket in to grooves of the wooden columns. Prints are easy by sliding in. Curved Menu Holders are made of the finest materials while providing the highest level of quality. To ensure sustainability of the quality, wood menu holders are lacquered finished which is resistant to spill of food and fizzy drinks.



No tool assembly.



Channel of wooden columns is 0.17"



PET pocket included.

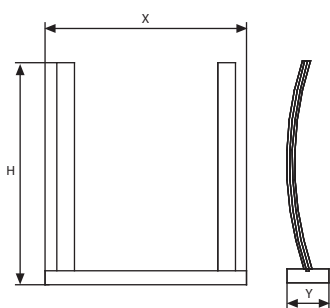

MATERIAL : Beech wood						WEIGHT	PACKING SIZE (2 Pcs)
NATURAL WOOD	DARK WOOD	SIZE	X	Y	H	WITH PACKING	*W X H X D
UWDMOCN058	UWDMOCD058	5.5"X8.5"	8.66"	2.36"	8.66"		9.84" X 11.02" X 3.15"
UWDMOCN081	UWDMOCD081	8.5"X11"	11.34"	2.36"	12.52"		13.39" X 13.78" X 3.15"

*W:Width H:Height D:Depth





Ticket Holder

new



Made of solid Beech wood, Ticker Holders are mobile options for displaying menus, business cards, price tickets, gift cards or many other purposes. It is nicely lacquered finished with round corners. It is good for displaying both ways. Ticket Holder is suitable for both indoor and outdoor places such as shops, restaurants, cafes and bars. To ensure sustainability of the quality, Ticket Holders are lacquered finished which is resistant to spill of food and fizzy drinks.

-  Each unit comes ready to use.
-  Groove is 0.08" and 90 degrees.
-  Packed in multiples. Suitable for silk screen printing, max. letter height is 0.47"



Natural Wood

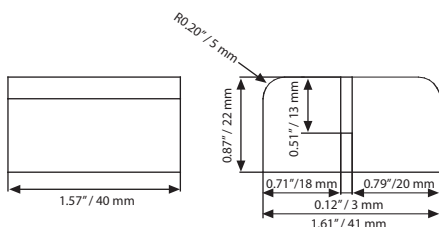

Dark Wood

MATERIAL : Beech wood			WEIGHT	PACKING SIZE (10 Pcs)
ARTICLE	SIZE	DESCRIPTION	WITH PACKING	*W X H X D
UWTHON0010	40 X 41 mm	Natural Wood		
UWTHOD0010	40 X 41 mm	Dark Wood		



* W:Width H: Height D: Depth

Card Holder 2 Sided

new



Made of solid Beech wood, Card Holder is double sided mobile options for displaying menus, business cards, price tickets, gift cards or many other purposes. It is nicely lacquered finished with round corners. It is good for displaying both ways. There are one channel on each side of Card holder one of which is 90 degrees angle and other one of which is 75 degrees angle. Card Holder is suitable for both indoor and outdoor places such as shops, restaurants, cafes and bars. To ensure sustainability of the quality, Card Holder is lacquered finished which is resistant to spill of food and fizzy drinks.



Each unit comes ready to use
Jeder Artikel wird fertig zum Einsatz geliefert.



Both groove is 4,5 mm, one of which is 90 degrees and other one is 75 degrees.
Beide Nuten sind 4,5 mm, eine davon ist 90 Grad und die andere 75 Grad.



Packed in multiples. Suitable for silk screen printing, max. letter height is 18 mm.
Vielfachpackung. Für Siebdruck geeignet max. Buchstabenhöhe 18 mm.

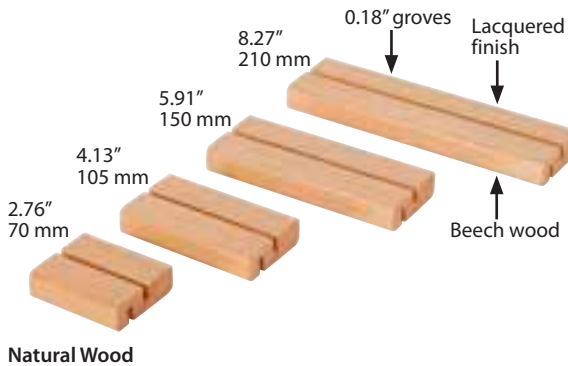
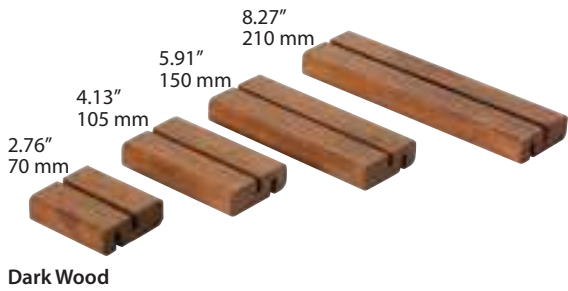

Dark Wood 75°Angled
8.27", Acrylic optional



Dark Wood 90°Angled
8.27", Chalkboard optional



Dark Wood 90°Angled
5.91", Acrylic optional



Natural Wood 90°Angled
4.13", Acrylic optional



Natural Wood 75°Angled
4.13", Chalkboard optional



Natural Wood 75°Angled
2.76", Acrylic optional

Do not forget to order PET, or Acrylic pockets or Chalkboard

ACRYLIC POCKET U TYPE			
ARTICLE	POSTER	W	H
UPCUAD0081	8.5" X 11"	8.5"	11.18"
UPCUAD0058	5.5" X 8.5"	5.83"	8.66"

PET POCKET U TYPE			
ARTICLE	POSTER	W	H
UPCUPD0081	8.5" X 11"	8.5"	11.10"
UPCUPD0058	5.5" X 8.5"	5.83"	8.58"

CHALKBOARD			
ARTICLE	SIZE	W	H
UPCUWD0081	216 X 280 mm	216 mm	283 mm
UPCUWD0058	140 X 216 mm	148 mm	219 mm

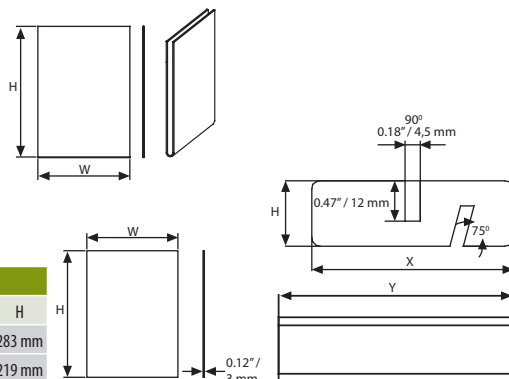

MATERIAL : Beech wood						WEIGHT	PACKING SIZE (10Pcs)
ARTICLE	SIZE	DESCRIPTION	X	Y	H	WITH PACKING	*W X H X D
UWCHON0070	2.76"	Natural Wood	2.36"	2.76"	0.79"		3.94" X 5.91" X 5.51"
UWCHON105	4.13"	Natural Wood	2.36"	4.13"	0.79"		5.31" X 5.91" X 5.51"
UWCHON150	5.91"	Natural Wood	2.36"	5.91"	0.79"		7.09" X 5.91" X 5.51"
UWCHOD0210	8.27"	Natural Wood	2.36"	8.27"	0.79"		5.91" X 230 X 5.51"
UWCHOD0070	2.76"	Dark Wood	2.36"	2.76"	0.79"		3.94" X 5.91" X 5.51"
UWCHOD105	4.13"	Dark Wood	2.36"	4.13"	0.79"		5.31" X 5.91" X 5.51"
UWCHOD150	5.91"	Dark Wood	2.36"	5.91"	0.79"		7.09" X 5.91" X 5.51"
UWCHOD0210	8.27"	Dark Wood	2.36"	8.27"	0.79"		5.91" X 230 X 5.51"



* W:Width H: Height D: Depth

Pyramid Card Holder Single Sided

new



Made of solid Beech wood, Pyramid Card Holder is mobile option for displaying menus, business cards, price tickets, or many other announcement purposes. It is nicely lacquered finished with round corners. It is good for displaying both ways. Pyramid Card Holder is suitable for both indoor and outdoor places such as shops, restaurants, cafes and bars. To ensure sustainability of the quality, Pyramid Card Holders are lacquered finished which is resistant to spill of food and fizzy drinks.

- Each unit comes ready to use
Jeder Artikel wird fertig zum Einsatz geliefert.
- Groove is 4,5 mm and 90 degrees. Suitable for branding.
Die Nut ist 4,5 mm und 90 Grad. Können mit Marke versehen werden
- Packed in multiples. Suitable for silk screen printing, max. letter height is 25 mm.
In Vielfachpackungen. Für Siebdruck geeignet max. Buchstabenhöhe 25 mm.

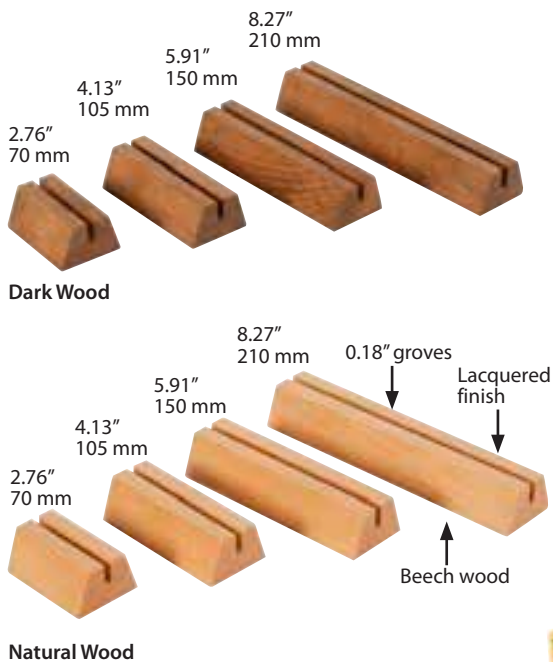

Dark Wood - 8.27"
Acrylic optional



Dark Wood - 5.91"
Chalkboard optional



Dark Wood - 4.13"
Acrylic optional



Dark Wood - 2.76"
Chalkboard optional



Natural Wood - 2.76"
Acrylic optional



Natural Wood - 4.13"
Chalkboard optional



Natural Wood - 5.91"
Acrylic optional



Natural Wood - 8.27"
Chalkboard optional

Do not forget to order PET, or Acrylic pockets or Chalkboard

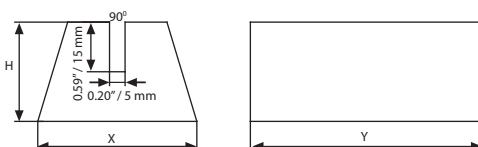

MATERIAL : Beech wood						WEIGHT	PACKING SIZE (10Pcs)
ARTICLE	SIZE	DESCRIPTION	X	Y	H	WITH PACKING	*W X H X D
UWCHPN0070	2.76"	Natural Wood	1.89"	2.76"	1.18"		3.15" X 9.84" X 3.54"
UWCHPN0105	4.13"	Natural Wood	1.89"	4.13"	1.18"		3.15" X 9.84" X 5.12"
UWCHPN0150	5.91"	Natural Wood	1.89"	5.91"	1.18"		3.15" X 9.84" X 6.69"
UWCHPN0210	8.27"	Natural Wood	1.89"	8.27"	1.18"		3.15" X 9.84" X 9.06"
UWCHPD0070	2.76"	Dark Wood	1.89"	2.76"	1.18"		3.15" X 9.84" X 3.54"
UWCHPD0105	4.13"	Dark Wood	1.89"	4.13"	1.18"		3.15" X 9.84" X 5.12"
UWCHPD0150	5.91"	Dark Wood	1.89"	5.91"	1.18"		3.15" X 9.84" X 6.69"
UWCHPD0210	8.27"	Dark Wood	1.89"	8.27"	1.18"		3.15" X 9.84" X 9.06"

* W:Width H: Height D: Depth





Arc Menu Holder

new



See movie at our website www.mtdisplays.com.tr

Modern style Arc Menu Holder features a curved design for more modernized appearance. With a contemporary design, this menu holder can be used to display notices, advertisements, graphics, menus and more. Flip up magnetic cover makes the change of poster easy. Simply flip up the anti-reflex cover and place the print underneath it. Suitable for use in restaurants, retail stores and any commercial environment.

-  No assembly required .
-  Unique curved design.
-  Magnetic PET cover included.

Color options

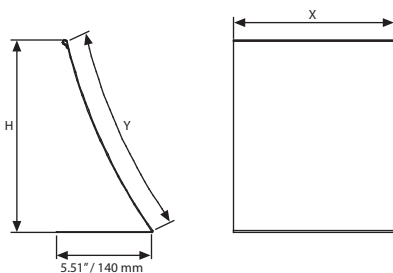

MATERIAL : Sheet metal						WEIGHT	PACKING SIZE
ARTICLE	EXTERNAL (x-y)	POSTER	COPY	H	DESCRIPTOIN	WITH PACKING	*W X H X D
UMSAMP0G81	246 X 310 mm	8.5" X 11"	8.35" X 10.87"	10.83"	Silver		
UMSAMP0B81	246 X 310 mm	8.5" X 11"	8.35" X 10.87"	10.83"	Black		



* W:Width H: Height D: Depth



Accessories

- Hangers
- Baskets
- Shelves
- Header Holder & Header
- Bags
- Levertool
- Separator
- Chalkboard Marker
- Lighting Components
- Panel
- Other



Accessories



Hanger / UYAA002100
Stopper on the frames for 1" double sided frames. Packed in 10.



Hanger / UYAA002200
Stopper on the frames for 1.26" double sided frames. Packed in 10.

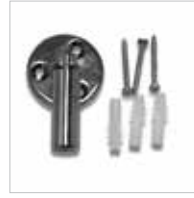

Hanger / UYAA000000
Ceiling and floor hanger for double sided frames. Packed in 5.



Hanger / UYAA001000
Ceiling hanger for double sided frames. Packed in 10.



Hanger / UYAA001100
Ceiling hanging kit for sizes B1, A0, B0, 30"x40", 40"x60". Packed in 10.



Hanger / UYAA007000
Plastic hanger for stretch frame. Packed in 10.



Hanger / UYAA004000
Wire Cable.



Hanger / UYAA006010
Suction cap for Wall Sign System. Packed in 10.



Hanger / UYAA001030
Ceiling hanger for double sided frames for small sizes. (8.5"x11" to 24"x36"). Packed in 10.



Hanger / UYAA001130
Ceiling hanger for double sided frames for big sizes. (27"x40" to 40"x60"). Packed in 10.



Hanger / UYAA006000
Suction cap for Stretch Frame. Packed in 10.



Hanger / UYAA005000
Ball chain for stretch frame.



Baskets / UYTS3000A4
A board basket 8.5"x11" size to hang on scissors.



Shelf / UFSL002000
Steel shelf for Display Stans.



Shelf / UFSL003000
Acrylic shelf for Display Stans.



Shelf / UFSL120000
Acrylic shelf for Display Stans. 8.5"x11".



Shelf / UFSL002100
2x(5.5"x8.5") Steel shelf for Display Stans & Adjustable Menuboard.



Shelf / UFSL003100
2x(5.5"x8.5") Acrylic shelf for Display Stans & Adjustable Menuboard.



Shelf / UFSL002200
1x (8.5"x11") Steel shelf for Display Stans.



Shelf / UFSL003200
1x (8.5"x11") Acrylic shelf for Free Standing Leaflet.

For the packing details and minimum quantities please contact our sales executives.

Accessories



Shelf / UFSL003300
1x(8.5"x11") Acrylic shelf for Free Standing.



Shelf / UFSL145000
(8.5"x11") Acrylic side shelf for Free Standing Leaflet.



Shelf
Single sided acrylic shelves for Poster Stands and Brochure Sets.

ARTICLE	SIZE
UYRT0002A4	2 X (8.5" X 11")
UYRT0003A4	3 X (8.5" X 11")



Shelf
Double sided acrylic shelves for Poster Stands and Brochure Sets.

ARTICLE	SIZE
UYRC0002A4	4 X (8.5" X 11")
UYRC0003A4	6 X (8.5" X 11")



Shelf / UFSL002560
MDF shelf for Display Stans.



Shelf / UFSL002500
MDF shelf for Display Stans.



Shelf / UFSL002550
MDF shelf for Display Stans.



Shelf / UFSL002510
MDF shelf for Display Stans.



Shelf / UYMGB00000
Shelf for Magnetic Glass Board.



Header / UFSL120200
Free Standing Leaflet Dispensers with Side Shelf header.



Header / UFSL120100
Free Standing header.



Header
Swingpro® Lite & Windpro® Lite header (PVC Foam).

ARTICLE	SIZE
UYFT004022	22" X 28"
UYFT004024	24 X 36"
UYFT004034	30" X 40"
UYFT004084	28" X 44"



Header
Eco Swingmaster & Eco Waterbase Wind Sign header (PVC Foam).

ARTICLE	SIZE
UYFT005022	22" X 28"
UYFT005023	20" X 30"
UYFT005024	24 X 36"
UYFT005034	30" X 40"
UYFT005046	40" X 60"



Header
Swingpro® Plus & Windpro® Plus header (PVC Foam).

ARTICLE	SIZE
UYFT005022	22" X 28"
UYFT005023	20" X 30"
UYFT005024	24 X 36"
UYFT005034	30" X 40"
UYFT0050F0	F0



Header
A Board header (PVC Foam).

ARTICLE	SIZE	DESCRIPTION
UYFT000023	20" X 30"	for 0.16"
UYFT000022	22" X 28"	for 0.16"
UYFT000024	24" X 36"	for 0.16"
UYFT000034	30" X 40"	for 0.16"
UYFT250022	20" X 30"	for 1"
UYFT250024	24" X 36"	for 1"



Header Holder
A Board wire header holder.

ARTICLE	SIZE	DESCRIPTION
UYTT000023	20" X 30"	for 0.16"
UYTT000022	22" X 28"	for 0.16"
UYTT000024	24" X 36"	for 0.16"
UYTT000034	30" X 40"	for 0.16"
UYTT250022	20" X 30"	for 1"
UYTT250024	24" X 36"	for 1"

For the packing details and minimum quantities please contact our sales executives.

Accessories



Bag
Black carry bag for single sided Quick Banner, Adjustable Quick Banner, single sided Smart Roll Banner.

ARTICLE	SIZE
UYUP064000	800 mm
UYUP065000	1080 mm
UYUP066000	880 mm
UYUP067000	1030 mm



Bag
Black carry bag for Eco-roller.

ARTICLE	SIZE
UYUP070500	800 mm
UYUP070600	1000mm



Bag
Black carry bag for double sided Smart Roll Banner.

ARTICLE	SIZE
UYUP070000	800 mm
UYUP071000	1000mm



Bag / UYUP072000
Black carry bag for Portable Zick-Zack 18.90" x 19.69" x 10.63".



Bag / UPP0110000
Pop-up carry bag for all size.



Bag / UYP0TS2050
Bag for Seed Promostand with pole system.



Bag / UYUP072200
Bag for Promostand.



Bag / UYUP072300
Bag for Petit Promostand.



Bag / UYP0TS1050
Bag for Seed, Rectangular, Circle and Bean Promostands.



Bag / UYUP074000
Convex Panset counter table black carry bag.



Bag / UYUP075100
Panset black carry bag for logo for all size.



Bag / UYUP076100
Panset black carry bag main body for all size.



Bag / UYUP070200
Midsize Convex Panset counter table black carry bag.



Bag / UYUP074100
Hexagonal Panset counter table black carry bag.



Bag / UYUP072400
Black carry bag for Newage Portable Zick-Zack 14.96" x 18.50" x 211.02".



Levertool / UYUP047000
Levertool in Plastic for Security Frames 1" - 1.26". Packed in 20.



Levertool / UYUP047100
Levertool in Plastic for Security Frames 1.65". Packed in 20.



Lighting Component / UYUP367130
Lighting for Pop-ups.



Chalkboard Marker / UYAKLM1251
Colour chalkboard marker for Wood Display. 0.39" wide. 5 Pcs.



Chalkboard Marker / UYAKLM1250
White chalkboard marker for Wood Display. 0.39" wide. 3 Pcs.

For the packing details and minimum quantities please contact our sales executives.

Accessories



Panel
Easy go PVC
Foam panel.

PVC FOAM PANEL	SIZE
UYPEG30022	22" X 28"
UYPEG30024	24" X 36"

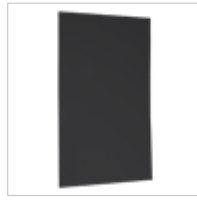

Panel
Easy go chalk panel.

CHALK PANEL	SIZE
UYPEG10022	22" X 28"
UYPEG10024	24" X 36"



Panel
Easy go write-on panel.

WRITE-ON PANEL	SIZE
UYPEG20022	22" X 28"
UYPEG20024	24" X 36"



Panel
Panel for Outdoor Flap
Gripper.

ARTICLE	SIZE
UYOFG10610	24.41" X 39.37"
UYOFG10612	24.41" X 47.24"
UYOFG10615	24.41" X 59.06"



Other / TSTDCI450B
Cable for all iPhones
& iPads. 3m Black.



Other / TSTDCIP40B
Cable for iPhone 4S,
iPad 3 and earlier.
3m Black.



Other / TSTDCIP50B
Cable for iPhone 5, iPad
4 and later. 3m Black.



Other / TSTDCV80B
Cable V8, micro USB for
Samsung, LG etc...



Other / UYPPD00000
USB Adaptor Lightning
to 30-pin.



Other / UYUP480945
WindPro Carriage tool.



Other / TZZZ998701
Cable Lock System
length 78.74", with
combination lock.



Other / UYTFB00000
Acrylic magnetic tray
for board marker .
Packed in 1.



Other / UQRP00L000
Blue-Chrome rope for
Q Ropes. Length 78.74"



Other / UQRP00B000
Black-Chrome rope for
Q Ropes. Length 78.74"



Other / UQRP00R000
Red-Chrome rope for
Q Ropes. Length 78.74"



Other / TWBTRT0210
Red-Gold rope for
Q Ropes. Length 118.11"



Other / UYUP397000
Magnetic buttons for
Boards. Packed in 10.



Other / UYUP397100
Pins for Boards.
Packed in 20.



Other / UYP0TS0030
Velcro Roll with double
sided tape 59 ft.



Poster Pocket
10 pcs of 1 colour in a box.

ARTICLE	PAPER SIZE	DESCRIPTION
TAB0590104	8.5" X 11"	Red
TAB0590101	8.5" X 11"	Black
TAB0590109	8.5" X 11"	Grey

For the packing details and minimum quantities please contact our sales executives.

Accessories



Grey Felt

Grey felt for Promostand.

ARTICLE	DESCRIPTION	SIZE
UYPOTSC03G	for Seed Promostand	35.43"
UYPOTSP03G	for Seed Promostand with Pole System	35.43"
UYPOTSD03G	for Rectangular Promostand	35.43"
UYPOTSR03G	for Circle Promostand	Ø 23.62"
UYPOTSB03G	for Bean Promostand	35.43"



Dimmer / UYUP445550

Optional dimmer to go with LED illuminated frame... Simply jack the dimmer in frame and then into powersupply. It adjust the light from dark to max lux of LED illuminated frame.



Semi Products

- Profiles
- Corners
- Connectors
- Springs
- End Caps
- Hangers
- Pipes
- Feet
- Counter Support
- Logo
- Shelf
- Panel
- Power Supply
- Base
- Others

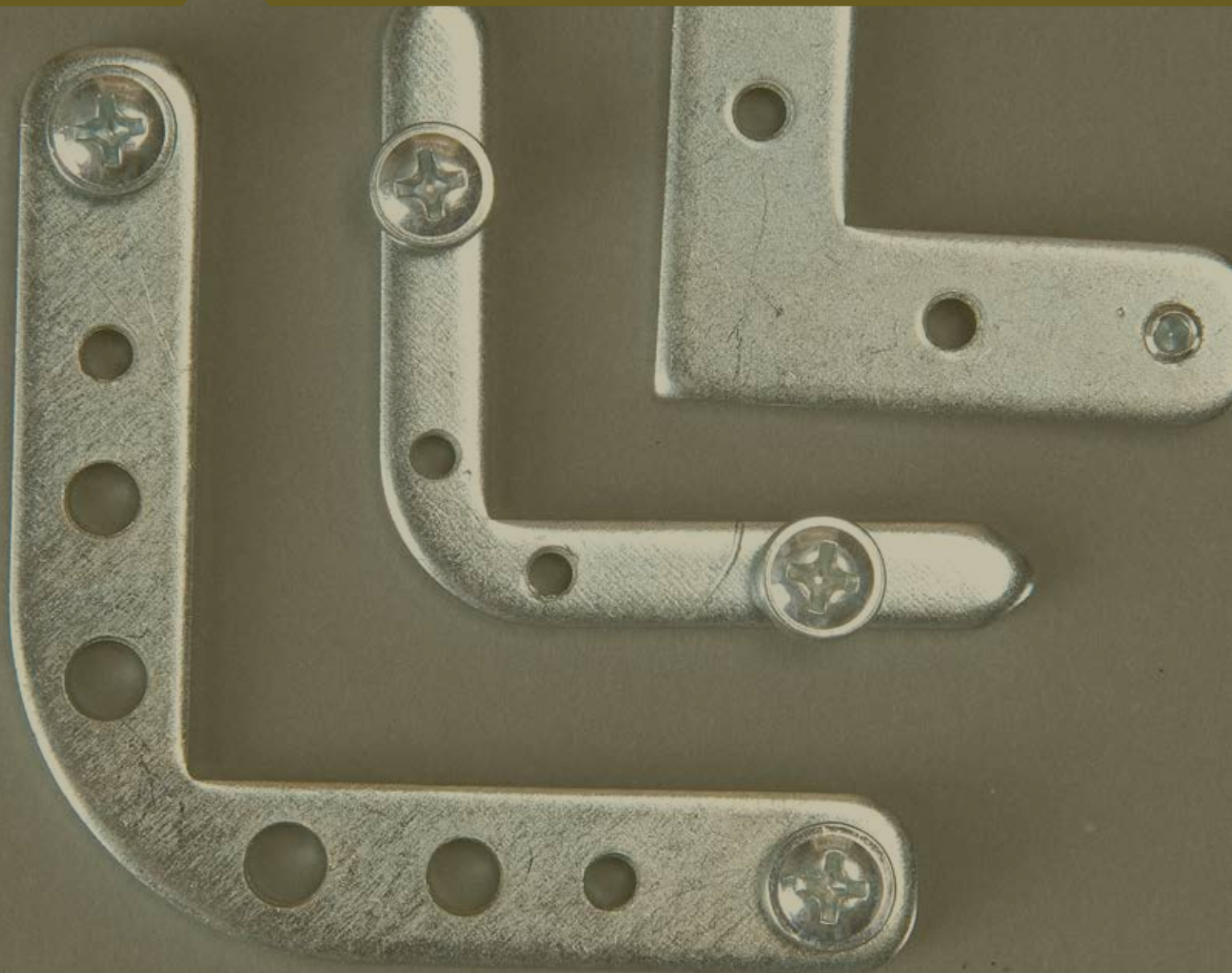

Semi Products

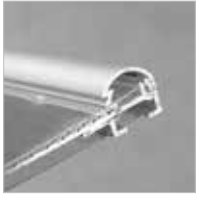

Profile / UYUP007700
0.59" Aluminium Snap profile set (top & bottom) in 118.11" without springs. Top Profile is silver anodized. Bottom profile is mill finished.



Profile / UYUP001000
0.79" Aluminium Snap profile set (top & bottom) in 118.11" without springs. Top Profile is silver anodized. Bottom profile is mill finished.

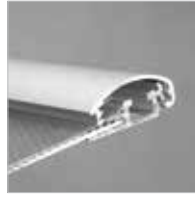

Profile / UYUP002000
1" Aluminium Snap profile set (top & bottom) in 118.11" without springs. Top Profile is silver anodized. Bottom profile is mill finished.



Profile / UYUP003400
26 mm Aluminium Snap profile set (top & bottom) in 118.11" without springs. Top Profile is silver anodized. Bottom profile is mill finished.



Profile / UYUP003300
1.02" Aluminium Poster Snap profile without springs & rubber. Top and bottom profiles are silver anodized.



Profile / UYUP003000
1.02" Aluminium Poster Snap profile with springs & rubber. Top and bottom profiles are silver anodized.

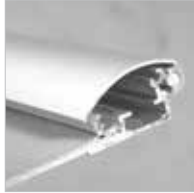

Profile / UYUP004000
1.18" Aluminium Snap profile set (top & bottom) in 118.11" without springs. Top Profile is silver anodized. Bottom profile is mill finished.

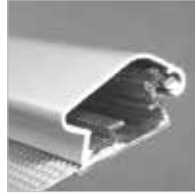

Profile / UYUP005000
1.26" Aluminium Snap profile set (top & bottom) in 118.11" without springs. Top Profile is silver anodized. Bottom profile is mill finished.



Profile / UYUP007800
1.50" Aluminium Snap profile set (top & bottom) in 118.11" without springs. Top Profile is silver anodized. Bottom profile is mill finished.



Profile / UYUP007000
1.77" Aluminium Snap profile set (top & bottom) in 118.11" without springs. Top Profile is silver anodized. Bottom profile is mill finished.



Profile / UYUP007200
1.81" Aluminium Snap profile set (top & bottom) in 118.11" without springs. Top Profile is silver anodized. Bottom profile is mill finished.



Profile / UYUP002100
1" Aluminium Security profile set (top & bottom) in 118.11" without springs. Top Profile is silver anodized. Bottom profile is mill finished.



Profile / UYUP008300
1.26" Aluminium Security profile set (top & bottom) in 118.11" without springs. Top Profile is silver anodized. Bottom profile is mill finished.

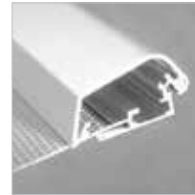

Profile / UYUP006000
1.65" Aluminium Security profile set (top & bottom) in 118.11" without springs. Top Profile is silver anodized. Bottom profile is mill finished.

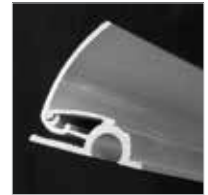

Profile / UYUP011000
Aluminium Poster Clamp profile. Top and bottom profiles are silver anodized.



Profile / UYUP013200
Aluminium Newage Poster Clamp profile. Top and bottom profiles are 118.11" silver anodized.



Profile / UYUP013100
Aluminium Fast Note Profile. 118.11" silver anodized.



Profile / UYUP012500
Aluminium Display Stands profile 2 channel. 118.11" silver anodized.



Profile / UYUP012550
Aluminium Display Stands profile 4 channel. 118.11" silver anodized.



Profile / UYUP012650
Novel Aluminium Display Stands profile 4 channel. 118.11" silver anodized.



Profile / UYUP011200
Poster Fast profile 118.11" silver anodized.



Profile / UYUP011900
Acrylic Side Shelf profile 118.11" silver anodized.



Profile / UYUP054000
Aluminium Stretch profile 118.11" silver anodized.



Profile / UYUP007920
0.35" Frameboard profile 118.11" silver anodized.



Profile / UYUP008000
Aluminium Circle Pipe profile 118.11" silver anodized Ø0.63".

For the packing details and minimum quantities please contact our sales executives.

Semi Products



Profile / UYUP007600
Aluminium profile for Free Standing Banner Set.



Profile / UYUP010000
2.01" Aluminium Elips profile silver anodized in 118.11".



Profile / UYUP009000
1.69" Aluminium Elips profile silver anodized in 118.11".



Profile / UYUP012000
Aluminium anodized profile rectangular.

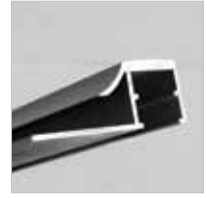

Profile / UYUP014850
Profile for single sided slide-in frame. 118.11", 2 channels.

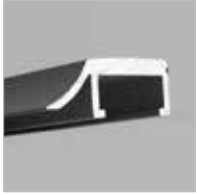

Profile / UYUP014950
Profile for single sided slide-in frame. 118.11", 1 channels.

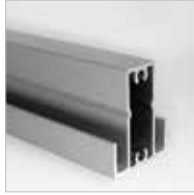

Profile / UYUP012400
Cocktail Brochure set profile. 118.11".



Profile / UYUP014800
Profile for double sided slide-in frame. 118.1", 2 channels.



Profile / UYUP014900
Profile for double sided slide-in frame. 118.11", 1 channels.



Profile / UYUP010510
Elips profile with channel.



Profile / UYUP012800
Multiside Brochure set & Rapid Brochure set profile. 118.11".



Profile / UYUP012900
Rapid Brochure set middle profile. 118.11".

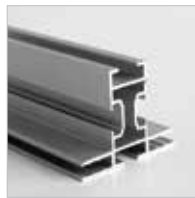

Profile / UYUP014101
Double Sided Maxi profile. King Frame Profile. 118.11", 1.97"x1.57".

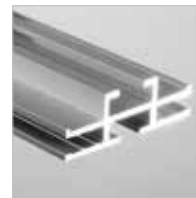

Profile / UYUP014104
Double Sided Maxi profile. Queen Frame Profile. 118.11", 1.77"x0.59".

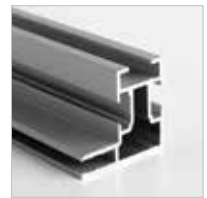

Profile / UYUP014102
Single Sided Maxi profile. Dame Frame Profile. 118.11", 1.34"x1.26".



Profile / UYUP014103
Single Sided Maxi profile. Valet Frame Profile. 118.11", 0.59"x0.87".

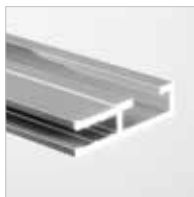

Profile / UYUP014105
Single Sided Maxi profile. Ace Frame Profile. 118.11", 1.26"x0.31".



Profile
Aluminium profile for Power LED Maxi Frames.



Profile
Aluminium profile for Omni Frame.



Profile
Wall Sign profile, 118.11".

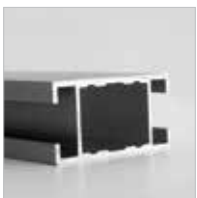

Profile / UYUP014106
H profile for Maxi frames. 118.11", 1.42"x0.75".

ARTICLE	LENGHT
UYPLPT1010	39.37"
UYPLPT1015	59.06"
UYPLPT1020	78.74"
UYPLPT1025	98.43"
UYPLPT1030	118.11"
UYPLPT1040	157.48"
UYPLPT1050	196.85"
UYPLPT1060	236.22"

ARTICLE	LENGHT
UYPOM00042	42"
UYPOM00062	62"
UYPOM00082	82"
UYPOM00122	122"
UYPOM00140	140"
UYPOM00182	182"
UYPOM00200	200"

ARTICLE	SIZE
UYUP021900	2.05"
UYUP021910	2.91"
UYUP021920	3.70"
UYUP021930	4.13"
UYUP021940	5.83"

For the packing details and minimum quantities please contact our sales executives.

Semi Products



Corner / UYUP027000
Round corner with connector for 1.26" profile. Packed in 10.



Corner / UYUP028000
Round corner with connector for 1" profile. Packed in 10.



Corner / UYUP028500
Round corner with connector for 1.81" profile. Packed in 10.



Corner / UYUP027500
Round corner with connector for 1.02" profile. Packed in 10.



Corner / UYUP056000
Stretch frame plastic corner. Packed in 4.



Connector / UYUP024000
Corner connector of frames for 0.79"-1"-1.02". Packed in 10.



Corner / UYUP029000
Round corner with connector for 1.18" profile. Packed in 10.



Connector / UYUP025600
Corner connector of frames for 1.81". Packed in 10.



Connector / UYUP025400
Corner fittings for lightbox profile. Packed in 10.



Connector / UYUP445000
Free Standing unit connector for 1.18"/1.26" Frames & Poster Showboard. Packed in 20.



Connector / UYUP445100
Free Standing unit connector for 1" Frame. Packed in 20.



Connector / UYUP445200
Free Standing connector for Steel & Acrylic Shelf without support arm. Packed in 20.



Connector / UYUP445300
Free Standing connector for Noticeboard. Packed in 20.



Connector / UYUP371100
Single Banner connector. Packed in 10.



Connector / UYUP015000
Elips Profile connector for 2.01". Packed in 8.



Connector / UYUP016000
Elips Profile connector for 1.69". Packed in 4.



Connector / UYUP025000
Corner connector of frames for 1.18"-1.26"-1.65"-1.77". Packed in 10.



Connector / UYUP025200
Corner connector of frames for 0.59". Packed in 10.



Connector / UYUP412295
Corner Cleat for Maxi Frame. Packed in 8.



Connector / UYUP412291
Straight Cleat for H profile of Maxi Frame. Packed in 8.



Connector / UYUP412270
Square corner connector for Maxi frame. Packed in 10.



Connector / UYUP412310
Straight Cleat for H profile of Maxi Frame. Packed in 12.



Connector / UYUP412320
Connector for Ocean, Gulf, Lagoon and Bay Maxi frame profile. Packed in 10.



Connector / UYUP412330
Connector for Gulf Maxi frame profile. Packed in 10.



Connector / UYUP490000
Multiside & Cocktail Brochure set shelf connector. Packed in 10.

For the packing details and minimum quantities please contact our sales executives.

Semi Products



Connector / UYUP290240
Shelf support for Free Standing. Packed in 10.



Connector / UYUP062000
Quick Banner connector with screws. Packed in 20.



Connector / UYUP364000
Frame connector for Panset Wall System. Packed in 10.



Connector / UYAA017500
Connector for Fishing line. Packed in 50.



Connector / UYAA017000
Connector for wire cable. Packed in 50.



Connector / UYAA012500
Top connector for single sided frame. Packed in 20.



Connector / UYAA012000
Bottom connector for single sided frame. Packed in 20.



Connector / UYUP450180
Side stopper for Pop-ups. Packed in 4.



Connector / UYUP025700
Corner connector of double sided slide-in frame. Packed in 10.



Connector / UYUP013000
T connector for 0.83" Elips Profile. Packed in 10.



Connector / UYUP014000
T connector for 1.69" Elips Profile. Packed in 10.



Connector / UYUPOM02000
Connector Bracket for Omni Frame



Connector / UYUPOM03000
T Connector for Omni Frame.



Connector / UYUPOM06000
Profile Connector for Omni Frame.



Connector / UYUPOM04000
Wall Fixing for Omni Frame.



Spring
Packed in 500.



Spring / UYUP450110
Spring for Pop-ups. Packed in 1 pcs.



End Cap / UYUP021200
End caps for Fast Note hole cover. Packed in 10.



End Cap / UYUP017000
End caps Elips profile for 2.01". Packed in 10.



End Cap / UYUP017500
End cap of Elips profile with channel. Packed in 10.

ARTICLE	FOR
UYUP110000	1.02"
UYUP030000	0.79"
UYUP031000	1"
UYUP032000	0.59"
UYUP032500	1.25"
UYUP032600	1.26"-Security
UYUP300000	1"-Security
UYUP310000	1.18"
UYUP350000	1.65" - 1.81"
UYUP361000	1.77"



End Cap / UYUP019010
Steel pipe end cap Ø1". Packed in 10.



End Cap / UYUP018000
End caps Elips profile for 1.69". Packed in 10.



End Cap / UYUP019000
End caps for Rectangular. Packed in 10.



End Cap / UYUP012300
End caps for Free Standing Banner Set. Packed in 10.

For the packing details and minimum quantities please contact our sales executives.

Semi Products



End Cap / UYUP449600
Poster profile end cap for Poster Fast. Packed in 10.



End Cap / UYUP020000
End caps for Quick Banner. Packed in 10.



End Cap / UYUP021000
Poster Profile end cap for 1.02". Packed in 10.



End Cap / UYUP021500
Rapid Brochure set end cap. Packed in 10.



End Cap / UYUP012200
End caps for Acrylic Side Shelf. Packed in 10.



End Cap / UYUP019500
Plastic cap for Free Standing. Packed in 2.

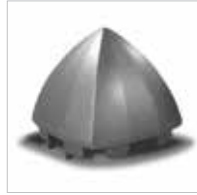

End Cap / UYUP019600
Plastic cap for Free Standing. Packed in 2.



End Cap / UYUP019400
Plastic cap for Novel Free Standing. Packed in 2.



End Cap / UYUP021400
End caps for Newage Poster Clamp. Packed in 10.



End Cap / UYUP021100
End caps for Fast Note. Packed in 10.



End Cap
Wall Sign Arc end caps Packed in 10.



End Cap
Wall Sign Flat end caps Packed in 10.



Hanger / UYAA018000
Hanger for 0.35" Frameboard. Packed in 10.



Hanger / UYAA011000
Metal hanger for Frame & Poster Snap. Packed in 10.



Hanger / UYAA011010
Metal portable hanger for Frame. Packed in 10.

ARTICLE	SIZE
UYUP021800	2.05"
UYUP021810	2.91"
UYUP021820	4.13"
UYUP021840	3.70"

ARTICLE	SIZE
UYUP021700	2.05"
UYUP021710	2.91"
UYUP021720	4.13"
UYUP021730	5.83"
UYUP021740	3.70"



Hanger / UYAA023000
Poster Gripper Hanger set. Packed in 10.



Hanger / UYUP055000
Plastic hanger for Stretch Frame. Packed in 10.



Hanger / UYUP075000
Poster Snap hanger. Packed in 10.



Hanger / UYUP076010
Newage Poster Clamp hanger. Packed in 10.



Hanger / UYUP076000
Poster Clamp hanger. Packed in 10.



Hanger / UYAA021000
Hanger for slide-in frame & poster fast set. Packed in 10.



Hanger / UYAA010000
Pipe&Clamp connector for double sided Smart Banner. Packed in 5.



Hanger / UYAA009000
Pipe&Clamp connector for single sided Smart Banner. Packed in 5.



Hanger / UYAA008000
Pipe&Clamp connector for single sided Quick Banner. Packed in 5.



Hanger / UYUP450130
Magnetic body connector with magnets for magnetic Pop-up. Packed in 2.

For the packing details and minimum quantities please contact our sales executives.



Hanger / UYUP450140
Mechanic body connector with panel hanger for Pop-up with clips. Packed in 2.



Hanger / UYUP450150
Magnetic end cap for aluminium profile for magnetic Pop-up. Packed in 10.



Hanger / UYUP450160
Mechanic end cap for aluminium profile for Pop-up with clips. Packed in 10.



Hanger / UYUP450065
Clips bar with magnetic tape.



Hanger / UYUP450075
Magnet bar with magnetic tape.



Hanger
Top&bottom straps set for Pop-up with clips.

ARTICLE	FOR
UYUP450000	3X3
UYUP450010	3X4



Hanger
Top&bottom straps set for magnetic Pop-up.

ARTICLE	FOR
UYUP450020	3X3
UYUP450030	3X4



Hanger / UYUP460245
Hanging system for Lagoon Maxi Frame including wire cable. Packed in 8.



Pipes / UYUP061100
Telescopic pipe for double sided Smart Roll Banner.



Pipes / UYUP061000
Telescopic pipe for single sided Smart Roll Banner.



Pipes / UYUP053000
7.87"



Pole / UYUP052000
7.87" Quick pipe in 3 part.



Feet / UYUP366000
Panset foot at the bottom for Panset Wall System. Packed in 10.



Feet / UYUP023000
Plastic foot for Quick Banner. Packed in 10.



Feet / UYUP022000
Base for Quick Banner. Packed in 10.



Feet / UYUP412273
Baseball 17.72"x11.81"x0.24" for double sided king profile.



Feet / UYUP412271
Circle Ø17.72"x0.24" for double sided king profile.



Feet / UYUP412272
Hoop Ø17.72"x0.24" for double sided king profile.



Feet / UYUP412274
Fillet 19.69"x7.09"x0.24" for double sided king profile.



Feet / UYUP412275
Flat 15.75"x19.70"x0.20" for double sided king profile.



Counter Support / UYUP460200
For 8.5"x11" Opti Frame. Packed in 10.



Counter Support / UYUP460100
For 5.5"x8.5" Opti Frame. Packed in 10.



Counter Support / UYUP460000
For 4"x6" Opti Frame. Packed in 10.



Counter Support / UYUP057000
U wire for Snap Frames.



Logo / UYUP407400
Rapid brochure set frosted logo.

For the packing details and minimum quantities please contact our sales executives.

Semi Products



Logo / UYUP407500
Rapid brochure set clear logo.



Shelf / UYR0007000
Rapid brochure set frosted shelf.

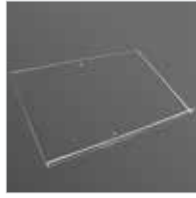

Shelf / UYR0008000
Folder menuboard clear acrylic shelf without ring.



Shelf
8.5"X11" shelf with connector.

ARTICLE	PACKED IN
UMSDA005A4	5
UMSDA008A4	8



Shelf / UYUP073101
8.5"x11" shelf for Portable Leaflet Dispensers. Packed in 8.



Shelf / UYUP073103
6.5"x8" shelf for Portable Leaflet Dispensers. Packed in 8.



Shelf / UYUP073102
4"x9" shelf for Portable Leaflet Dispensers. Packed in 8.



Panel
Opal acrylic

ARTICLE	SIZE	DESCRIPTION
UYUP407251	22" X 28"	Convex Lightbox
UYUP407270	20" X 30"	Convex Lightbox
UYUP407280	30" X 40"	Convex Lightbox
UYUP407121	27" X 67"	Totem
UYUP407131	27" X 77"	Totem



Panel
Anti-reflex PET Cover for Swing Master & Eco Swing Master

ARTICLE	SIZE	PET
UYUP088250	20" X 30"	21.14" X 31.14"
UYUP088260	30" X 40"	31.14" X 41.14"
UYUP088270	40" X 60"	41.14" X 61.14"



Panel
Anti-reflex PET Cover for Waterproof Snap frame 25 mm.

ARTICLE	SIZE	PET
UYUP088441	18" X 24"	19.30" X 25.30"
UYUP088442	22" X 28"	23.30" X 29.30"
UYUP088443	24" X 36"	25.30" X 37.30"

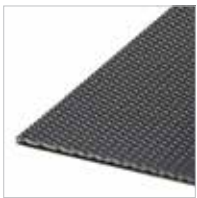

Panel
Polystyrene Backing.

ARTICLE	SIZE
UYUP093002	5" X 7"
UYUP093003	6" X 9"
UYUP093004	8" X 10"
UYUP093001	8.5" X 11"
UYUP094001	11" X 14"
UYUP094002	11" X 17"
UYUP094003	14" X 22"
UYUP095001	16" X 20"
UYUP095002	18" X 24"
UYUP097001	20" X 30"
UYUP044001	22" X 28"
UYUP044002	24" X 36"
UYUP096001	27" X 40"
UYUP099000	30" X 40"
UYUP100000	40" X 60"



Panel
Anti-reflex PET Cover.

ARTICLE	SIZE
UYUP081001	5" X 7"
UYUP082001	6" X 9"
UYUP083002	8" X 10"
UYUP083001	8.5" X 11"
UYUP084002	11" X 14"
UYUP084001	11" X 17"
UYUP084003	14" X 22"
UYUP084004	16" X 20"
UYUP088100	18" X 24"
UYUP090000	20" X 30"
UYUP088100	22" X 28"
UYUP088101	24" X 36"
UYUP088102	27" X 40"
UYUP091000	30" X 40"
UYUP092000	40" X 60"



Panel
Anti-reflex PET Cover for Waterproof Snap frame 35 mm.

ARTICLE	SIZE	PET
UYUP081001	5" X 7"	6.73" X 8.73"
UYUP082001	6" X 9"	7.73" X 10.73"
UYUP083002	8" X 10"	9.73" X 11.73"
UYUP083001	8.5" X 11"	10.23" X 12.73"
UYUP084002	11" X 14"	12.73" X 15.73"
UYUP084001	11" X 17"	12.73" X 18.73"
UYUP084003	14" X 22"	15.73" X 23.73"
UYUP084004	16" X 20"	17.73" X 21.73"
UYUP088100	18" X 24"	19.73" X 25.73"
UYUP090000	20" X 30"	21.73" X 31.73"
UYUP088100	22" X 28"	23.73" X 29.73"
UYUP088101	24" X 36"	25.73" X 37.73"
UYUP088102	27" X 40"	28.73" X 41.73"
UYUP091000	30" X 40"	31.73" X 41.73"
UYUP092000	40" X 60"	41.73" X 61.73"



Panel
Magnetic & Magneco LEDbox cover.

ARTICLE	SIZE
UYPML10017	11" X 17"
UYPML10024	18" X 24"
UYPML10023	20" X 30"
UYPML10022	22" X 28"
UYPML10024	24" X 36"
UYPML10034	30" X 40"



Panel
PVC panel complete for Pop-up table.

ARTICLE	FOR
UYUP450040	3x3
UYUP450050	3x4

For the packing details and minimum quantities please contact our sales executives.

Semi Products



Power Supply
Power supply for Ledbox.
Daily use 16h.

ARTICLE	DESCRIPTION
UYUP445441	Power supply US 1A
UYUP445450	Power supply EU 2A
UYUP445451	Power supply US 2A
UYUP445452	Power supply UK 2A
UYUP445460	Power supply EU 3A
UYUP445461	Power supply US 3A
UYUP445462	Power supply UK 3A
UYUP445490	Power supply EU 4A
UYUP445491	Power supply US 4A
UYUP445492	Power supply UK 4A
UYUP445510	Power supply EU 5A
UYUP445511	Power supply US 5A
UYUP445512	Power supply UK 5A
UYUP445520	Power supply EU 6A
UYUP445521	Power supply US 6A
UYUP445522	Power supply UK 6A

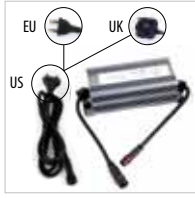

Power Supply
Power supply for Weatherproof
Ledbox. Daily use 16h.

ARTICLE	DESCRIPTION
UYPLD0103A	Power supply EU 3A for Weatherproof LEDbox
UYPLD0303A	Power supply US 3A for Weatherproof LEDbox
UYPLD0203A	Power supply UK 3A for Weatherproof LEDbox
UYPLD0104A	Power supply EU 4A for Weatherproof LEDbox
UYPLD0304A	Power supply US 4A for Weatherproof LEDbox
UYPLD0204A	Power supply UK 4A for Weatherproof LEDbox
UYPLD0105A	Power supply EU 5A for Weatherproof LEDbox
UYPLD0305A	Power supply US 5A for Weatherproof LEDbox
UYPLD0205A	Power supply UK 5A for Weatherproof LEDbox
UYPLD0106A	Power supply EU 6A for Weatherproof LEDbox
UYPLD0306A	Power supply US 6A for Weatherproof LEDbox
UYPLD0206A	Power supply UK 6A for Weatherproof LEDbox



Power Supply
Power supply for Ledbox.
Daily use 24h.

ARTICLE	DESCRIPTION
UYPLD00010	Power supply EU 3,34A 7/24 suitable
UYPLD02010	Power supply US 3,34A 7/24 suitable
UYPLD01010	Power supply UK 3,34A 7/24 suitable
UYPLD00011	Power supply EU 6,67A 7/24 suitable
UYPLD02011	Power supply US 6,67A 7/24 suitable
UYPLD01011	Power supply UK 6,67A 7/24 suitable
UYPLD00012	Power supply EU 8,5A 7/24 suitable
UYPLD02012	Power supply US 8,5A 7/24 suitable
UYPLD01012	Power supply UK 8,5A 7/24 suitable
UYPLD00013	Power supply EU 11,5A 7/24 suitable
UYPLD02013	Power supply US 11,5A 7/24 suitable
UYPLD01013	Power supply UK 11,5A 7/24 suitable



Power Supply / UYPSWL0020
Charger for WindPro with LED.



Power Supply / UYPSWL0010
Spare Battery for WindPro
with LED.



Base
Waterbase Wind Sign base.

ARTICLE	DESCRIPTION
UYUP406820	Small base
UYUP406810	Medium Base
UYUP406840	Large Base



Other / UYUP445600
Black foam tape for
Poster Snap.



Other / UYUP410300
Plastic Peg for Showboard.
Packed in 10.



Other / UYUP360110
Screw and Wall Plug
for Snap Frames.
Packed in 10.



Other / UYUP406410
Wheel and its fixture for
Waterbase.



Other / UYUP460220
Nylon strip with double
sided tape. 164 ft.



Other / UYUP449500
Plastic part in 1.57" for
Poster Fast. Packed in 10.



Other / UYUP021300
Roller for Fast Note.
Packed in 50.



Other / UYUP368100
Hinge for A Board.
Packed in 10.



Other / UYUP080000
Scissors for A Board.
Packed in 10.



Other / UYUP444000
Wheel for stands.
Packed in 1.



Other / UYUP290200
Fixing hardware for Free Standing
Leaflet Display. Packed in 10.



Other / UYUP480510
Top plate of Pop-up table.

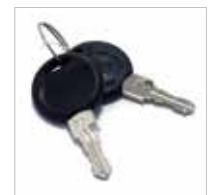

Other / UYUP427510
Key D20 for Showboards &
Noticeboards. Packed in 10.

For the packing details and minimum quantities please contact our sales executives.

Semi Products



Other / UYUP427520
Key for Universal Showboards. Single packed.



Other / UYUP427500
Lock for Showboards. Packed in 1.



Other / UYUP450120
Light hanger for Pop-ups. Packed in 5.



Other / UYUP450170
Spring holder fork for Pop-ups. Packed in 10.



Other / TSH4010S01
Black Bungee Cord with Stainless Steel Hook for Omni Frame.



Other / UYPOM05000
Plastic Button for Omni Frame.



Other / TMC4010S00
Plastic Clips for Omni Frame.



Other / UYPOM07000
Plastic Strap for Omni Frame.



Other / UYUP450100
Magnetic tape roll in 98 ft.



Other / UYAA004500
Fishing Line.



Other / UYUP460235
Clear nylon strip. 328 ft.



Other / UYUP365000
Cleat for Panset Wall System. Packed in 10.



Plastic Extrusion Lines

- PET Lines
- Plastech PVC Foam Lines
- Neo Plastech PVC Foam Lines
- Plasteco PVC Foam Lines
- HIPS Lines



PET Extrusion Lines

The PET line composes of one main extruder 75 dia. and one co-extruder dia. 45. It is a Battenfeld machine with a capacity of 1433 lbs/h as from 300 microns to 1500 microns. The surface options are matt/gloss and gloss/gloss. Transparent & colored alternatives are available. The maximum width is 55.12'. PET sheet line is integrated with very accurate Maxson sheet sizing unit. In addition to this, a 1 ton and 0.04" diameter capacity roll winder and an 8 pieces slitter in a standalone form wind and slit the sheets for the packaging industry. This machinery is fed by a fully automatic crystallizer and a dry air drier by Colortronic-Germany. A lot of alternative polymer sheets with antiblock-antislip agents, a UV stabilizer and optical brightener additives are available. The PET line with cold lamination units on both sides protects the film application while serving hot lamination for different sheet extrusion alternatives. For color options, please contact our sales department.

Composition:

PET is an abbreviation of Polyethylene Terephthalate. Chemical composition is (C₁₀H₈O₄)_n

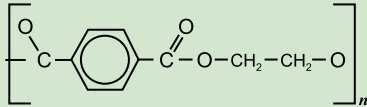

Application Areas : Signs. Food Packaging. Vacuum forming. Printing. Stationary. POS stands. White Goods Equipments. Construction Equipments.

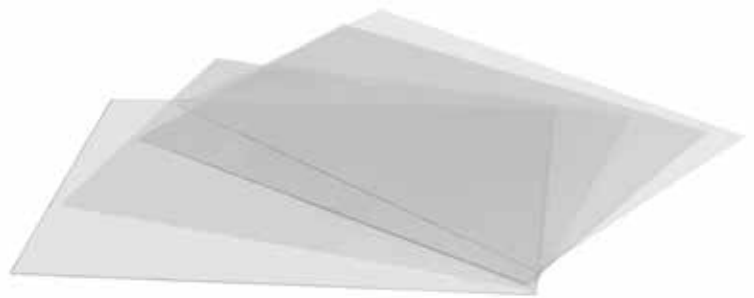

Operating Processes

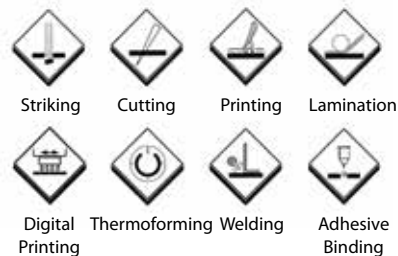

PET

Delivery Programme

Special Requirements on Request

- MOQ: 1 pallet/article
- Each pallet max. 1 ton
- Custom sizes and colours available (subjected to MOQ)
- UV, corona or silicon treatments available (subjected to MOQ)
- Film surcharge €0.20/m² one side, €0.40/m² on both sides.
- Available on reels



Rev. 01 - 27.03.2014

Production By Order - Transparent&White

Thickness	Sheet Size			Surface		Sheet / Pallet			Sheet / Pack		
	inch	3' 3/8" x 4' 1/8"	4' 1 7/32" x 6' 8 45/64"	4' 1/8" x 9' 10 7/16"	Matt	Gloss	3' 3/8" x 4' 1/8"	4' 1 7/32" x 6' 8 45/64"	4' 1/8" x 9' 10 7/16"	3' 3/8" x 4' 1/8"	4' 1 7/32" x 6' 8 45/64"
0.011"	✓	✓	n/a	✓	✓	2000	1000	n/a	100	50	n/a
0.015"	✓	✓	✓	✓	✓	1400	700	400	100	50	20
0.019"	✓	✓	✓	✓	✓	1000	600	350	50	50	n/a
0.023"	✓	✓	✓	✓	✓	900	500	300	50	30	20
0.027"	✓	✓	✓	✓	✓	750	450	250	50	30	20
0.030"	✓	✓	✓	✓	✓	750	450	250	50	30	20
0.040"	✓	✓	✓	✓	✓	540	300	180	50	30	20
0.060"	✓	✓	n/a	✓	✓	350	200	100	30	20	n/a

PET Sheet Tolerances

Tolerance in Thickness		Rectangularity	Off Line Cutting Width & Length Tolerances	On Line Cutting Width & Length Tolerances	Number Of Sheet Tolerance On A Pack
0.01" - 0.02" inch	max ±20micron	Rectangularity off line cutting max ±0.04" inch	max ±0.08" inch in length	max ±0.16" inch in length	max ±%2 sheets
0.03" - 0.04" inch	max ±25micron	Rectangularity on line cutting max ±0.08" inch	max ±0.04" inch in width	max ±0.08" inch in width	
0.04" - 0.06" inch	max ±30micron				

Test Reports

Test	Dimension	Standard	Value
Density	g/cm ³	DIN EN ISO 1183	1,34
Modulus of elasticity (tensile)	Mpa	DIN EN ISO 527-3, 1B/50, 0.03"/min till 5 Mpa, in direction of production	2460
Tensile stress at yield	Mpa	DIN EN ISO 527-3, 1B/50, 0.03"/min till 5 Mpa, in direction of production	41,5
Elongation at yield	%	DIN EN ISO 527-3, 1B/50, 0.03"/min till 5 Mpa, in direction of production	2,3
Breaking strength (20 °C)	MPa	DIN EN ISO 527-3, 1B/50 in direction of production	31,8
Elongation at break	%	DIN EN ISO 527-3, 1B/50 in direction of production	15,3
Modulus of elasticity (flexion)	MPa	DIN EN ISO 178, 0.07"/min till 1,5%, then 0.39"/min	2250
Flexural strength at 3.5 % flexion	MPa	DIN EN ISO 178, 0.07"/min till 1,5%, then 0.39"/min	61,5
Flexural strength , maximum	MPa	DIN EN ISO 178, 0.07"/min till 1,5%, then 0.39"/min	64,8
Impact strength at +23 °C	KJ/m ²	DIN EN ISO 179-1/1eU, in direction of production, support distance 2.44", 4 Joule Hammer	89,7
Impact strength notched at +23 °C	KJ/m ²	DIN EN ISO 179-1/1eU, in direction of production, support distance 2.44", 0,54 Joule Hammer and 1 Joule hammer (ABS)	21,6
Vicat softening point	KJ/m ²	DIN EN ISO 306, 50 K/h, load 50 N, procedure B	95
Water vapor permeability	g/(m ² d)	DIN EN ISO 15106-3 at 23 °C, 85% to 0% relative humidity	3,32
Glass transition temperature	°C	DIN EN ISO 11357-2 at 20 K/min	1,1 and 107,2
Melting temperature (Peak)	°C	DIN EN ISO 11357-3 at 20 K/min	---2)
Crystallization temperature	°C	DIN EN ISO 11357-3 at 20 K/min	---2)
Shore D hardness	-	DIN 53505	80
Lineer coefficient of thermal expansion (23-80 °C)	10 ⁻⁵ 1/K	ISO 11359-2, procedure B, 5 K/min in direction of production	9,7

Available From Stock - Transparent

Thickness inch	49 1/4" x 80 3/4"		55 1/8" x 118 1/8"	
	mat/gloss	gloss/gloss	mat/gloss	gloss/gloss
0.011"	n/a	DS FILM	n/a	n/a
0.019"	n/a	DS FILM	NO FILM	n/a
0.027"	n/a	DS FILM	n/a	n/a
0.029"	SS FILM	DS FILM	n/a	n/a
0.039"	SS FILM	DS FILM	SS FILM	DS FILM
0.059"	SS FILM	DS FILM	n/a	n/a

* DS FILM: Available as both side protected with film

* SS FILM: Available as gloss side protected with film

* NO FILM: Available as without film

Fire Classification

Country	Standard	Rating	Thickness	Colour
Germany	DIN EN ISO 11925-2	B2 (Indoors)	0.04" inch	Transparent
	DIN EN 13823			

PVC Foam Extrusion Lines

4 extrusion lines; one from Cincinati and 3 from Krauss Maffei. PVC Foam Extrusion Line has two parts which produce sheets from 0.04" to 0.75" thickness and from 48.03" to 80.71" width. The first part is AZO dozing unit which prepares PVC blend with different formulas. The second part is the line producing PVC foam sheets with different die widths and different thicknesses. The line also disposes of a movable saw cutting the sheets.

It has 3 dies;

die	Width inch	Lips	Lips Thickness
1	80 3/4"	2	0.04" - 0.20"
2	61 7/16"	3	0.04" - 0.24" / 0.24" - 0.75"
3	48 1/16"	3	0.04" - 0.24" / 0.24" - 0.39"

Each line has 1984 lbs / hour capacity.
All the lines have the ability of covering protection film on both sides one side of PVC Foam with cold lamination units.

Composition:
Vinyl chloride.

PVC  Plovinil Klorür -0, + 60 C

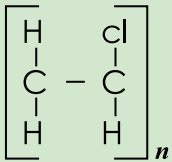

Application Areas : Signs, Digital Printing, Printing, Construction Industry, Shop Fittings, Health Sector, Furniture Sector, Sandwich Panels, Wall Coverings.

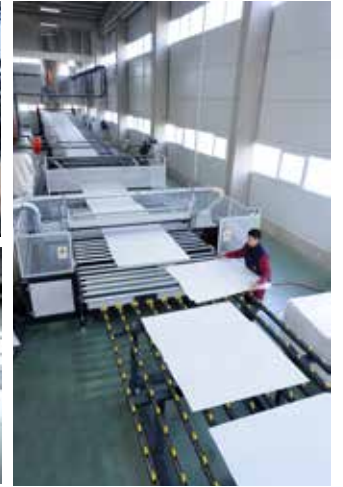

Operating Processes

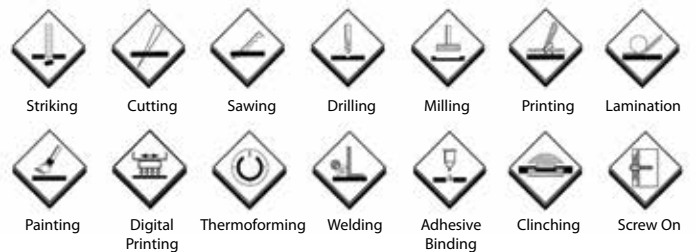

PVC Foam Delivery Programme

Protective Film

- PE film on one side as standard
- No branding over the film
- Digital marking of sizes over on long side

Tolerance Fixed For Each Thickness

- -0 to + 0.08" on width
- -0 to + 0.39" on length
- Rectangularity is max. 0.08" per meter

Tolerance in Thickness

- +/- 0.006" for 0.04"-0.08" thickness
- +/- 0.006" for 0.12"-0.24" thickness
- +/- 0.012" for 0.31"-0.39" thickness
- +/- 0.020" for 0.59"-0.75" thickness

*Tolerances are measured for on-line cutting

Special Requirements On Request

- Additional thicknesses as required
- Non standard sheet dimensions are available
- Protective PE film on both sides as required, surcharge +0.20 € / m²
- Cut sheet available on-line



Rev. 09 - 01.01.2016

PVC Foam Colour White

Thickness inch	5' 1 ¹ / ₂ ' x 10'	6' 8 ⁴⁵ / ₆₄ '
0.04"	✓	✓
0.08"	✓	✓
0.12"	✓	✓
0.16"	✓	✓
0.20"		✓
0.24"	✓	✓
0.31"	✓	✓
0.39"	✓	✓
0.59"	✓	
0.75"	✓	

* 0.59" and 0.75" are available only from stock, are not produced on order.

** 0.08" available by order with a lead time of 6-12 weeks.

*** Other thicknesses are produced on order (subject to moq).

Palet Quantities For Only Truck Deliveries

Thickness inch	5' 1 ¹ / ₂ ' x 10'	6' 8 ⁴⁵ / ₆₄ '
0.04"	250	200
0.08"	200	150
0.12"	120	100
0.16"	100	80
0.20"	80	60
0.24"	60	60
0.31"	50	40
0.39"	40	40
0.59"	30	
0.75"	25	



Physical Properties Of PVC Foam

Test	Test Method	Units	Average Result
Specific Gravity	In-House	g/cm ³	0.50-0.70
Determination of Water Absorption	ISO 62: Method 1	%	0.19
Tensile Strength at Yield	ISO R527	MPa	19.37
Elongation at Break	ISO R527	%	17.89
Flexural Modulus	ISO 176	GPa	0.903
Charpy Impact Strength	ISO 179	kJm ⁻²	1.43
Shore D Hardness	ISO 868	for 1-6 Value	40-47
		for 8-10 Value	40-47
Heat Distortion Temperature	ISO 75: Method A	°C	57.75
	ISO 75: Method B	°C	68.4
Coefficient of Linear Expansion	In-House	° ⁻¹ C	0.498x10.6

Fire Classification

Test	Test Method	Units	Average Result
Fire classification 0.12" & 0.20"	EN 13501-1	Class	C - s3, d1

Colour Red Available in Stock

Thickness inch	5' 1 ¹ / ₂ ' x 10'
0.12"	✓
0.20"	✓

Colour Black Available in Stock

Thickness inch	5' 1 ¹ / ₂ ' x 10'
0.12"	✓
0.20"	✓



PVC Foam Extrusion Lines



- Improved Whiteness.
- Suitable for direct printing.
- Single side protective film.
- 48 1/6" x 80 3/4" standard sheet dimension.
- 0.12" / 0.20" / 0.39" thickness available.
- Low Density.
- Best priced bright white printable PVC Foam .

Physical Properties of PVC Foam

Test	Test Method	Units	Average Result
Specific Gravity	In-House	g/cm3	0,45
Determination of Water Absorption	TS ISO 62:Method 1	%	0.20
Tensile Strength at Yield	TS EN ISO527-1, 527-2	MPa	10,54 - 11,13
Elongation at Break	TS EN ISO527-1, 527-2	%	10 - 14
Heat Distortion Temperature	ISO 179-1 Method A	C°	59°C
	ISO 179-1 Method B	C°	65°C
Charpy Impact Strength	TS ISO 179-1	kJ/m ²	9,3
Shore D Hardness	ISO 868	for 0.12"	33 - 34
	ISO 868	for 0.20"	35 - 36

Pallet Quantities for Only Truck Deliveries

Thickness inch	48 1/6" x 88 1/4"	48 1/6" x 120 1/8"	61 7/16" x 120 1/8"	80 3/4" x 120 1/8"
0.08"	200	200	200	150
0.12"	150	150	140	120
0.16"	140	140	120	100
0.20"	120	120	100	80
0.24"	80	80	-	70
0.31"	60	60	60	50
0.39"	50	50	50	40

NEO Plastech PVC Foam Colour White

Thickness mm	48 1/6" x 88 1/4"	48 1/6" x 120 1/8"	61 7/16" x 120 1/8"	80 3/4" x 120 1/8"
2	✓	✓	✓	✓
3	✓	✓	✓	✓
4	-	-	✓	✓
5	✓	✓	✓	✓
6	-	-	-	✓
8	✓	✓	✓	✓
10	✓	✓	✓	✓

Fire Classification

Test	Test Method	Units	Average Result
Fire classification 3mm	EN 11925-2	Class	C - s2, d0
Fire classification 5mm	EN 11925-2	Class	C - s3, d0
Fire classification 10 mm	EN 11925-2	Class	C - s3, d0

Application Areas : Signs, Digital Printing, Printing, Construction Industry, Shop Fittings, Health Sector, Furniture Sector, Sandwich Panels, Wall Coverings.



Operating Processes

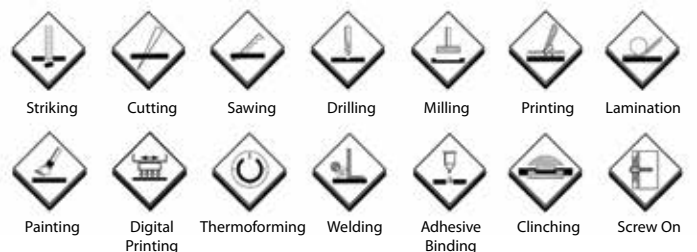

PLASTEKO

PVC Foam Extrusion Lines

- White
- Suitable for lamination, letter cutting and similar application.
- Single side non-branded protective film.
- 61^{7/16}" x 120^{1/8}", 80^{3/4}" x 120^{1/8}" standard sheet dimension.
- 0.10" / 0.12" / 0.18" / 0.20" / 0.35" thickness available.
- Low Density, 0,40gr/m3
- Best price

Pallet Quantities for Only Truck Deliveries

Thickness inch	61 ^{7/16} " x 120 ^{1/8} "	80 ^{3/4} " x 120 ^{1/8} "
0.10"	175	150
0.12"	140	120
0.18"	120	100
0.20"	100	80
0.35"	60	50

PLASTEKO PVC Foam Colour White

Thickness inch	61 ^{7/16} " x 120 ^{1/8} "	80 ^{3/4} " x 120 ^{1/8} "
0.10"	✓	✓
0.12"	✓	✓
0.18"	✓	✓
0.20"	✓	✓
0.35"	✓	✓

With or without protection film.



Application Areas : Signs, Digital Printing, Printing, Construction Industry, Shop Fittings, Health Sector, Furniture Sector, Sandwich Panels, Wall Coverings.

Operating Processes



HIPS

Extrusion Lines



HIPS Line is available to produce one, two, three or five layers HIPS, ABS and ABS+PMMA sheets from 0.04" to 0.24" thicknesses so different colors and with different additives. It is a Battenfeld machine. Although this line has a movable guillotine to cut the sheets according to customers' needs, the precise final cut is still conducted by a supplementary INPRO sheeter. This line is also fed by Colortronic driers and dosing equipments.

	Minimum	Maximum
Thickness	0.04"	0.24"
Width	19.69"	80.71"
Length	19.69"	236.22"

For special sizes and tolerances of up to 0.03" sheets can be ordered.

HIPS Sheet						
Thickness	Sheet Sizes			Colour	Surface	Sheet quantity
inch	3' 3 ^{3/8} " x 4' 1 ^{1/8} "	4' 1 ^{7/32} " x 6' 8 ^{45/64} "	6' 8 ^{45/64} "	White and Grey	Embossed and Smooth	per pallet
0.03"	x	x	x			900/500/200
0.04"	x	x	x			700/350/150
0.06"	x	x	x			450/250/100
0.08"	x	x	x			350/185/75
0.12"		x	x		225/125/50	

The information and recommendations in this brochure are accurate and reliable to the best of our knowledge, however users should perform their own tests to determine the suitability of these products for their own particular purposes.

Composition:

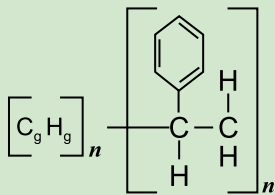

HIPS High impact polystyrene -5, + 80 C







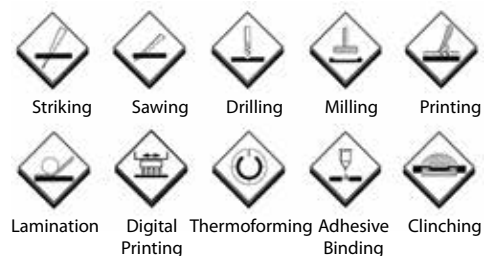































Application Areas : Signs, White Goods Equipments (Refrigerator Interiors), Sanitary Sector (Shower Doors), Packaging, Electrical components, Toy components, Furniture Sector, Interior dividing panels.



Operating Processes



Symbols

 New 2019	 Use with Magnet Buttons	 Light Kit	 Double Sided	 Waterbase
 Weatherproof	 Wheels Optional	 Patented	 Fittings Included	 Use with
 Round Corner	 Safe Corner	 Mitred Corner	 Sliding	 Magnetic Surface
 Different Variation	 Use with Pin	 Swing Door	 With Support	 Allen Key
 Door Hinged	 Height Adjustable	 Use Double Sided Tape	 Movie Available	 Slide Door
 Lock System	 Chalkboard	 Use with Velcro	 M&T Products	 Trade Products
 5 Year Warranty	 3 Year Warranty	 2 Year Warranty	 1 Year Warranty	 Fire Resistant
 Wind Resistant	 Light Weight	 Excellent stability	 Easy Poster Change	

RAL Colour Chart

ral 1000	ral 1001	ral 1002	ral 8093	ral 1604	ral 1025	ral 1095	ral 3007	ral 1011	ral 1012	ral 5013	ral 7014	ral 1015	ral 3016	ral 1017	ral 8018
ral 1019	ral 1020	ral 1021	ral 1023	ral 1024	ral 1027	ral 1028	ral 3032	ral 1033	ral 1034	ral 2000	ral 2001	ral 2002	ral 2003	ral 2004	ral 2008
ral 2009	ral 2010	ral 2011	ral 2012	ral 3000	ral 3001	ral 3002	ral 3003	ral 3004	ral 3005	ral 3007	ral 3009	ral 3011	ral 3012	ral 3013	ral 3014
ral 3015	ral 3016	ral 3017	ral 3018	ral 3020	ral 3022	ral 3027	ral 3031	ral 4001	ral 4002	ral 4003	ral 4004	ral 4005	ral 4006	ral 4007	ral 4008
ral 4009	ral 5000	ral 5001	ral 5002	ral 5003	ral 5004	ral 5005	ral 5007	ral 5008	ral 5009	ral 5010	ral 5011	ral 5012	ral 5013	ral 5014	ral 5015
ral 5017	ral 5018	ral 5019	ral 5020	ral 5021	ral 5022	ral 5023	ral 5024	ral 6000	ral 6001	ral 6002	ral 6003	ral 6004	ral 6005	ral 6006	ral 6007
ral 6008	ral 6009	ral 6010	ral 6011	ral 6012	ral 6013	ral 6014	ral 6015	ral 6016	ral 6017	ral 6018	ral 6019	ral 6020	ral 6021	ral 6022	ral 6024
ral 6025	ral 6026	ral 6027	ral 6028	ral 6029	ral 6032	ral 6033	ral 6034	ral 7000	ral 7001	ral 7001	ral 7002	ral 7003	ral 7004	ral 7005	ral 7006
ral 7008	ral 7009	ral 7010	ral 7011	ral 7012	ral 7013	ral 7015	ral 7016	ral 7021	ral 7022	ral 7023	ral 7024	ral 7026	ral 7030	ral 7031	ral 7032
ral 7033	ral 7034	ral 7035	ral 7036	ral 7037	ral 7038	ral 7039	ral 7040	ral 7042	ral 7043	ral 7044	ral 8000	ral 8001	ral 8002	ral 8003	ral 8004
ral 8007	ral 8008	ral 8011	ral 8012	ral 8014	ral 8015	ral 8016	ral 8017	ral 8019	ral 8022	ral 8023	ral 8024	ral 8025	ral 8028	ral 9001	ral 9002
ral 9003	ral 9004	ral 9005	ral 9010	ral 9011	ral 9016	ral 9017	ral 9018								



MT DISPLAYS LLC
 1081 Hanover St.
 Wilkes-Barre, PA 18706
 Toll Free: +1 855 678 1000
 T: 201.636.4144
 F: 201.636.4145
 info@mtdisplaysllc.com
 www.mtdisplaysllc.com

www.displayshowroom.com
 www.omni-frame.com
 www.mt-digitalsignage.com
 www.mtplastech.com
 www.opti-frame.com
 www.displayacademy.com



Issue 03 - 05/2019 - 1200626

