

SECURITY FRAME



SECURELY DISPLAY YOUR MESSAGES IN HEAVY TRAFFIC COMMERCIAL AREAS

Security Frames make it easy to display various posters securely. These quality secure frames, which are also known as poster signs, poster holders and poster frames fit in different business environments and are appropriate for all industries. Each secure poster frame works just like regular snap frame. However with these secure frames you need a lever tool to snap open the sides. This feature makes this frame tamper-proof.

KEY SELECTION ATTRIBUTES

- Suitable for open-air use or highly frequented areas accessible to the public.
- 1" version ideal for various medium-scale poster sizes.
- 1.65" version ideal for various large-scale poster sizes.
- Natural silver-anodized and various RAL colors available with antimicrobial powder coating.
- Standard mitred corners.
- Secure hard-to-open profiles.
- Anti-glare poster cover sheet.
- Optional V-Hangers for easy mounting.



1"



1.26"



COLOURS IN STOCK

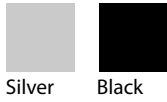

Silver Black

COLOUR OPTIONS

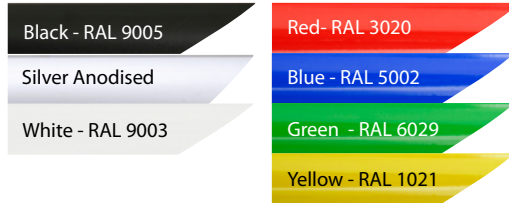

CORNER TYPES

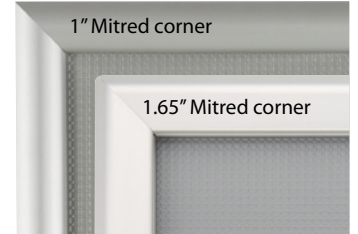

SUITABLE FOR

Security Frame can be used for INDOOR applications, for displaying messages and announcements safely in heavy traffic areas like shopping centers, markets, groceries, hotels, offices airports, shops and stores, hospitals, schools, apartments, banks, exhibition halls, restaurants, retail stores, elevators, movie theatres, sports and entertainment centers, trade shows, government agencies and many more.

FEATURES

1"



1.65"



EXPLODED VIEW

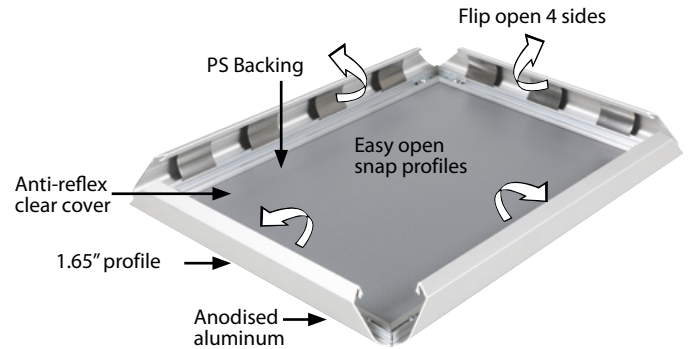
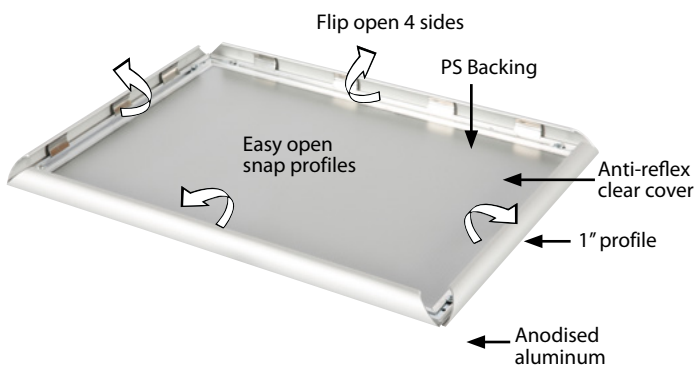

ARTICLES

PROFILE : 25 mm Security				WEIGHT	PACKING SIZE
ARTICLE	EXTERNAL (x-y)	POSTER	COPY	WITH PACKING	*W X H X D
VDA3660192	9.69" X 12.17"	8.5" X 11"	7.72" X 10.20"	1.102 lbs	10.63" X 12.99" X 0.83"
VDA3660133	23.19" X 29.17"	22" X 28"	21.22" X 27.20"	3.637 lbs	24.02" X 30.31" X 0.83"
VDA3660134	21.18" X 31.18"	20" X 30"	19.21" X 29.21"	3.637 lbs	22.44" X 32.28" X 1.22"
VDA3660135	25.20" X 37.17"	24" X 36"	23.23" X 35.20"	5.070 lbs	25.98" X 38.58" X 0.83"
VDA3660145	31.18" X 41.18"	30" X 40"	29.21" X 39.21"	6.944 lbs	31.89" X 42.13" X 0.91"

OPTIONAL ACCESSORIES

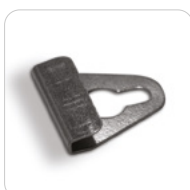

V Hanger



Levertool 1"



Levertool 1.65"



T: +1 855-478-0652 / info@displaysoutlet.com/ www.displaysoutlet.com

PHYSICAL DATA

Material

1" and 1.65" aluminum profiles.
PET poster cover, PS backing or ABS backing.

Poster Material & Thickness

0.0039" – 0.0078" for standard product. Max poster thickness 4 mm for 1" profile, 0.27" for 0.15" profile. Any non-standard poster thicknesses should be indicated with order.

Surface Finish

Silver anodized, or black colour, antimicrobial powder coating. Custom colors also available, call for custom color requests.

Recycled Content

Up to 78% recycled content used.

Warranty

All products are guaranteed for 3 years by Displays Outlet with below conditions:
[Warranty Conditions](#)

Installation Considerations

Each frame includes wall mounting accessories (4 screws & 4 plugs). Each frame is packed individually in a cardboard box. "Optional hangers" permit easy mounting. The lever tool should be ordered separately, not included in the original pack.

Storage Conditions

Goods should be stored at 32°F to 77°F in a dry place. Store in the original package.

Design Considerations

Suitable for silk screen printing, max. letter height is 0.59" for 1". Suitable for silk screen printing, max. letter height is 0.82" for 1.65"

Cleaning and Disinfecting

Clean your displays, with damp microfiber clothes, rinsed with simply water or warm, soapy or gentle shampooed water. Avoid using vinegar, abrasive, acidic, alcohol-based or heavy cleaners or cleaners containing Ammonia. Only after cleaning the product, if needed, simply apply disinfectant or sanitizer that is in compliance with your local guidelines and regulations.

Hazardous Substances

Displays Outlet prioritizes compliance with the REACH (Registration, Evaluation, Authorisation and Restriction of Chemicals) and RoHS (Restriction of Hazardous Substances) directives to protect both the environment and human health. We ensure that our products do not contain substances listed under REACH and adhere to strict RoHS limits for hazardous materials. Our manufacturing process ensures that lead, mercury, cadmium, and other restricted substances remain within the permitted thresholds, guaranteeing safe and sustainable products for our customers.

PRINT TEMPLATES

Security Frame 1" - 8.5"x11"

Document Size: 8.9" x 11.4" (Includes Bleeds)
Finished Size: 8.5"x11"

Security Frame 1" - 20"x30"

Document Size: 20.4" x 30.4" (Includes Bleeds)
Finished Size: 20"x30"

Security Frame 1" - 22"x28"

Document Size: 22.4" x 28.4" (Includes Bleeds)
Finished Size: 22"x28"

Security Frame 1" - 24"x36"

Document Size: 24.4" x 36.4" (Includes Bleeds)
Finished Size: 24"x36"

Security Frame 1" - 30"x40"

Document Size: 30.4" x 40.4" (Includes Bleeds)
Finished Size: 30"x40"

Security Frame 1" - 40"x60"

Document Size: 40.4" x 60.4" (Includes Bleeds)
Finished Size: 40"x60"

Security Frame 1.65" - 20"x30"

Document Size: 20.4" x 30.4" (Includes Bleeds)
Finished Size: 20"x30"

Security Frame 1.65" - 30"x40"

Document Size: 30.4" x 40.4" (Includes Bleeds)
Finished Size: 30"x40"

Security Frame 1.65" - 40"x60"

Document Size: 40.4" x 60.4" (Includes Bleeds)
Finished Size: 40"x60"

TECHNICAL DRAWING

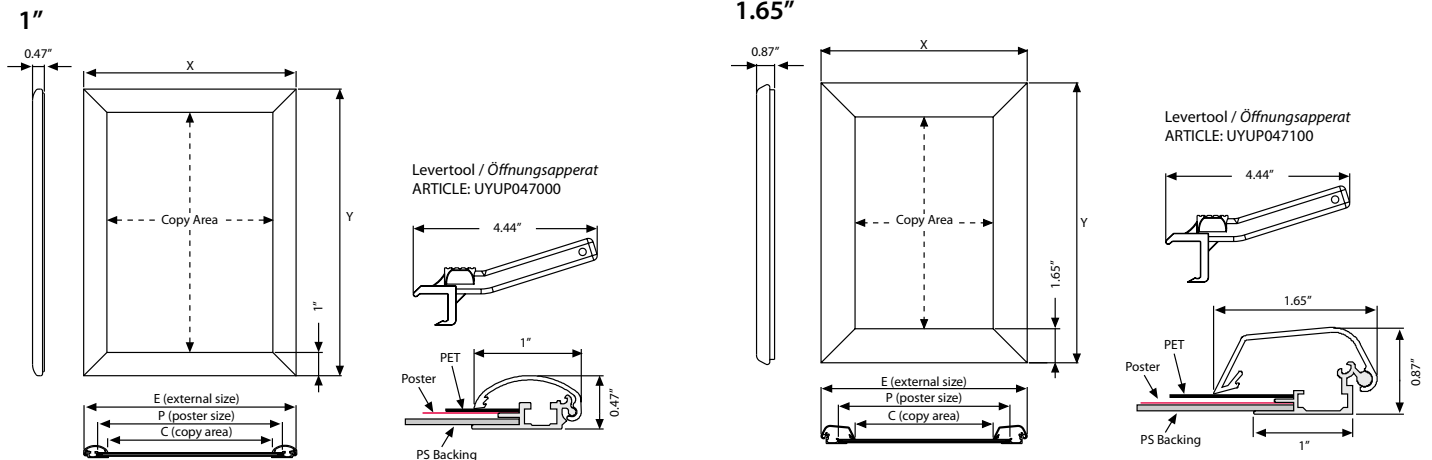

INSTALLATION INSTRUCTIONS

Security Frame / 1001856

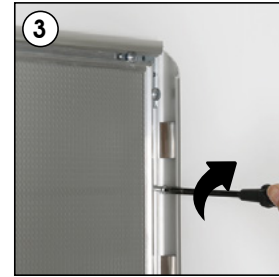
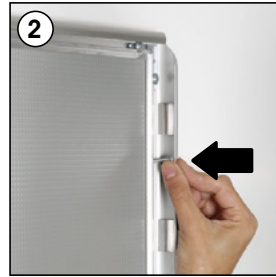
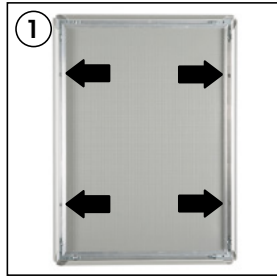
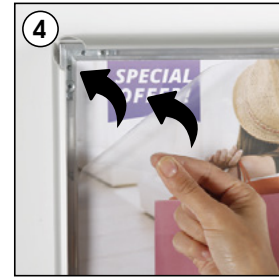
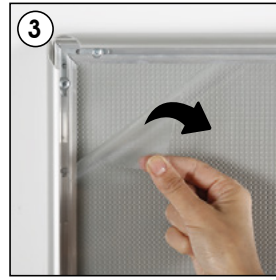

Screw & anchor mounting

Each frame includes wall mounting accessories
(4 screws & 4 anchors)



- Please inform the order number on the product or on the carton (e.g. 1/110001394-460) to the place that you have made the purchase if any problem with the product occurs.
- All rights reserved. All pictures, figures and writings are secured internationally by copy-right law. Infringements will be sued by civil and legal law.

This technical sheet's contents are all subject to update and modification at Displays Outlet exclusive discretion. There is nothing official about this document. For final and legally binding information, please get in touch with the sales staff at Displays Outlet.



T: +1 855-478-0652 / info@displaysoutlet.com/ www.displaysoutlet.com